

Panasonic®

Operating Instructions Functional Manual

UHD LCD Display For business use

| | | |
|-----------|-----------|---------------|
| Model No. | TH-98SQ1W | 98-inch model |
| | TH-86SQ1W | 86-inch model |
| | TH-75SQ1W | 75-inch model |
| | TH-65SQ1W | 65-inch model |
| | TH-55SQ1W | 55-inch model |
| | TH-49SQ1W | 49-inch model |

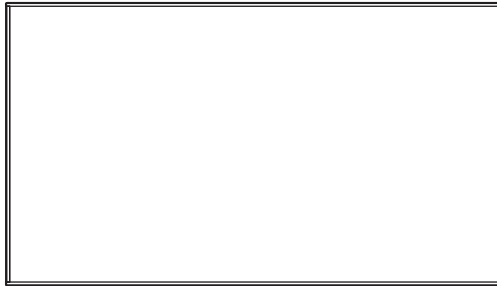

4K
PROFESSIONAL
*Actual resolution:
3840 × 2160p

English

Please read these instructions before operating your set and retain them for future reference.



HDMI™

Dear Panasonic Customer

Welcome to the Panasonic family of customers. We hope that you will have many years of enjoyment from your new LCD Display.

To obtain maximum benefit from your set, please read these Instructions before making any adjustments, and retain them for future reference.

Retain your purchase receipt also, and note down the model number and serial number of your set in the space provided on the rear cover of these instructions.

Visit our Panasonic Web Site

<https://panasonic.net/cns/prodisplays/>

Table of Contents

Before use

- Illustrations and screens in this Operating Instructions are images for illustration purposes, and may be different from the actual ones.
- Descriptive illustrations in this Operating Instructions are created mainly based on the 98-inch model.

| | |
|--|-----------|
| Important Safety Instructions | 4 |
| FCC STATEMENT | 5 |
| Important Safety Notice | 6 |
| Safety Precautions | 8 |
| Precautions for use | 11 |
| Accessories | 13 |
| Accessories Supply | 13 |
| Remote Control Batteries | 14 |
| Attaching the USB Memory Cover | 14 |
| Attaching the Function Board | 15 |
| Cautions when moving | 17 |
| Eyebolt | 18 |
| Connections | 19 |
| AC cord connection and fixing / Cable fixing | 19 |
| Video equipment connection | 21 |
| Before connecting | 22 |
| HDMI 1 and HDMI 2 terminals connection | 22 |
| DVI-D IN terminal connection | 23 |
| PC IN terminal connection | 24 |
| DisplayPort IN / DisplayPort OUT terminal connection | 25 |
| DIGITAL LINK terminal connection | 27 |
| SERIAL IN terminal connection | 28 |
| IR IN / IR OUT terminal connection | 29 |
| AUDIO OUT terminal connection | 30 |
| USB terminal connection | 30 |
| Speaker terminal connection | 31 |
| Identifying Controls | 32 |
| Display | 32 |
| Remote Control Transmitter | 34 |
| Basic Controls | 35 |
| Selecting the input signal | 37 |
| RECALL | 38 |
| Volume Adjustment | 38 |
| Sound mute On / Off | 38 |
| OFF TIMER | 39 |
| ASPECT Controls | 40 |
| Digital ZOOM | 42 |
| On-Screen Menu Displays | 43 |
| Adjusting Position | 45 |
| Auto setup | 45 |

| | |
|--|------------|
| Sound Adjustment | 47 |
| Picture Adjustments | 48 |
| Picture Profiles | 51 |
| Saving profiles..... | 52 |
| Loading profiles..... | 53 |
| Editing profiles..... | 53 |
| Setup menu | 55 |
| Multi display settings..... | 55 |
| Portrait settings..... | 58 |
| Signal..... | 59 |
| Power on settings..... | 62 |
| Input search..... | 63 |
| Failover/Failback..... | 65 |
| Screensaver..... | 67 |
| Input label..... | 69 |
| Power management settings..... | 69 |
| Audio input select..... | 71 |
| HDMI-CEC settings..... | 72 |
| Image settings..... | 73 |
| Input lock..... | 74 |
| Off-timer function..... | 74 |
| No activity power off..... | 74 |
| OSD language..... | 74 |
| Set up timer..... | 75 |
| Date and time..... | 76 |
| Network settings..... | 77 |
| USB media player settings..... | 81 |
| Memory viewer settings..... | 83 |
| Screen Transfer settings..... | 84 |
| Function button settings..... | 84 |
| OSD settings..... | 86 |
| Display orientation..... | 86 |
| Image rotation..... | 87 |
| Options..... | 87 |
| Control settings..... | 87 |
| Information timing..... | 88 |
| SLOT settings..... | 88 |
| Maximum VOL function..... | 89 |
| Maximum VOL level..... | 89 |
| Button lock..... | 89 |
| POWER button lock..... | 89 |
| Controller user level..... | 89 |
| DVI-D/SLOT select..... | 90 |
| USB select..... | 90 |
| Quick input change mode..... | 90 |
| Using Network Function | 91 |
| Necessary environment for computers to be connected..... | 91 |
| Example of network connection..... | 91 |
| Command control..... | 93 |
| Control Command via LAN..... | 93 |
| PJLink protocol..... | 97 |
| Multi Monitoring & Control Software..... | 98 |
| Video Wall Manager..... | 98 |
| Content Management Software..... | 99 |
| Screen Transfer..... | 99 |
| Connecting with LAN | 100 |
| Computer operation..... | 100 |
| Using Web Browser Control | 100 |
| Before Using Web Browser Control..... | 100 |
| Access from Web Browser..... | 101 |
| Operating with Web Browser..... | 102 |
| Using “USB media player” | 111 |
| Function description..... | 111 |
| Preparation..... | 112 |
| Playing back the files..... | 114 |
| Network environment (Multi Media Player only)..... | 117 |
| Starting / ending Media Player..... | 117 |
| Resume Play function..... | 118 |
| Playlist edit function..... | 118 |
| Schedule playback function using “Content Management Software”..... | 120 |
| Using “Memory viewer” | 123 |
| Preparation..... | 123 |
| Displaying the “Memory viewer” screen..... | 124 |
| Playing the pictures..... | 125 |
| Playing the video / music..... | 126 |
| Using HDMI-CEC function | 127 |
| Connection..... | 127 |
| Setting..... | 127 |
| Interlocking devices..... | 127 |
| Operating a device (using the remote control of this unit)..... | 128 |
| Using multi input display function of the multi display | 129 |
| Displaying 4 screens..... | 129 |
| Switching 4 screens to 1 screen..... | 129 |
| Using data cloning | 130 |
| Copying the display data to the USB memory..... | 130 |
| Copying (cloning) the USB memory data to the display..... | 131 |
| Copying data to other display via LAN..... | 132 |
| Changing the cloning password..... | 133 |
| USB memory network settings | 134 |
| Saving the LAN setting file to the USB memory device..... | 134 |
| Copying the USB memory data to the display..... | 135 |
| ID Remote Control Function | 136 |
| Setting the remote control’s ID number..... | 136 |
| Cancelling the setting of remote control’s ID number (ID “0”)..... | 136 |
| Entering characters | 137 |
| Preset Signals | 138 |
| Shipping condition | 141 |
| Initialization | 142 |
| Initializing the [Controller user level] | 142 |
| Troubleshooting | 143 |
| Specifications | 146 |
| Software License | 149 |



WARNING
RISK OF ELECTRIC SHOCK
DO NOT OPEN



WARNING: To reduce the risk of electric shock, do not remove cover or back.

No user-serviceable parts inside. Refer servicing to qualified service personnel.



The lightning flash with arrow-head within a triangle is intended to tell the user that parts inside the product are a risk of electric shock to persons.



The exclamation point within a triangle is intended to tell the user that important operating and servicing instructions are in the papers with the appliance.

WARNING:

To prevent damage which may result in fire or shock hazard, do not expose this apparatus to rain or moisture.

Do not place containers with water (flower vase, cups, cosmetics, etc.) above the set. (including on shelves above, etc.)

WARNING:

- 1) To prevent electric shock, do not remove cover. No user serviceable parts inside. Refer servicing to qualified service personnel.
- 2) Do not remove the grounding pin on the power plug. This apparatus is equipped with a three pin grounding-type power plug. This plug will only fit a grounding-type power outlet. This is a safety feature. If you are unable to insert the plug into the outlet, contact an electrician.
Do not defeat the purpose of the grounding plug.

Important Safety Instructions

- 1) Read these instructions.
- 2) Keep these instructions.
- 3) Heed all warnings.
- 4) Follow all instructions.
- 5) Do not use this apparatus near water.
- 6) Clean only with dry cloth.
- 7) Do not block any ventilation openings. Install in accordance with the manufacturer's instructions.
- 8) Do not install near any heat sources such as radiators, heat registers, stoves, or other apparatus (including amplifiers) that produce heat.
- 9) Do not defeat the safety purpose of the polarized or grounding-type plug. A polarized plug has two blades with one wider than the other. A grounding type plug has two blades and a third grounding prong. The wide blade or the third prong are provided for your safety. If the provided plug does not fit into your outlet, consult an electrician for replacement of the obsolete outlet.
- 10) Protect the power cord from being walked on or pinched particularly at plugs, convenience receptacles, and the point where they exit from the apparatus.
- 11) Only use attachments / accessories specified by the manufacturer.
- 12) Use only with the cart, stand, tripod, bracket, or table specified by the manufacturer, or sold with the apparatus. When a cart is used, use caution when moving the cart / apparatus combination to avoid injury from tip-over. 
- 13) Unplug this apparatus during lightning storms or when unused for long periods of time.
- 14) Refer all servicing to qualified service personnel. Servicing is required when the apparatus has been damaged in any way, such as power-supply cord or plug is damaged, liquid has been spilled or objects have fallen into the apparatus, the apparatus has been exposed to rain or moisture, does not operate normally, or has been dropped.
- 15) To prevent electric shock, ensure the grounding pin on the AC cord power plug is securely connected.

FCC STATEMENT

This equipment has been tested and found to comply with the limits for a class A digital device, pursuant to Part 15 of the FCC Rules. These limits are designed to provide reasonable protection against harmful interference when the equipment is operated in a commercial environment. This equipment generates, uses and can radiate radio frequency energy and, if not installed and used in accordance with the instructions manual, may cause harmful interference to radio communications. Operation of this equipment in a residential area is likely to cause harmful interference in which case the user will be required to correct the interference at his own expense.

FCC CAUTION:

To assure continued compliance, follow the attached installation instructions and use only the provided power supply cord. Any changes or modifications not expressly approved by Panasonic Corp. of North America could void the user's authority to operate this device.

Supplier's Declaration of Conformity

Model No.

TH-98SQ1W, TH-86SQ1W, TH-75SQ1W,
TH-65SQ1W, TH-55SQ1W, TH-49SQ1W

Responsible Party:

Panasonic Corporation of North America
Two Riverfront Plaza, Newark, New Jersey
07102-5490

Contact Source:

Panasonic System Solutions Company of North
America

1-877-655-2357

General Contact:

<http://shop.panasonic.com/support>

This device complies with Part 15 of the FCC Rules and all applicable IC RSS standards. Operation is subject to the following two conditions: (1) This device may not cause harmful interference, and (2) this device must accept any interference received, including interference that may cause undesired operation.

CANADIAN NOTICE:

This Class A digital apparatus complies with Canadian ICES-003.

WARNING:

- Not for use in a computer room as defined in the Standard for the Protection of Electronic Computer/ Data Processing Equipment, ANSI/NFPA 75.
- For permanently connected equipment, a readily accessible disconnect device shall be incorporated in the building installation wiring.
- For pluggable equipment, the socket-outlet shall be installed near the equipment and shall be easily accessible.

Note:

Image retention may occur. If you display a still picture for an extended period, the image might remain on the screen. However, it will disappear when a general moving picture is displayed for a while.

Trademark Credits

- Microsoft, Windows, Internet Explorer and Microsoft Edge are the registered trademarks or trademarks of Microsoft Corporation in the United States and/or other countries.
- Mac, macOS and Safari are the trademarks of Apple Inc. registered in the United States and other countries.
- PJLink is a registered or pending trademark in Japan, the United States, and other countries and regions.
- HDMI, High-Definition Multimedia Interface and the HDMI Logo are trademarks or registered trademarks of HDMI Licensing Administrator, Inc. in the United States and other countries.
- JavaScript is a registered trademark or a trademark of Oracle Corporation and its subsidiary and associated companies in the United States and/or other countries.
- Crestron Connected, Crestron Connected logo, Crestron Fusion, Crestron RoomView and RoomView are trademarks or registered trademarks of Crestron Electronics, Inc. in the United States and/or other countries.

Even if no special notation has been made of company or product trademarks, these trademarks have been fully respected.

Important Safety Notice

WARNING

- 1) To prevent damage which may result in fire or shock hazard, do not expose this appliance to dripping or splashing.
Do not place containers with water (flower vase, cups, cosmetics, etc.) above the set. (including on shelves above, etc.)
No naked flame sources, such as lighted candles, should be placed on / above the set.
- 2) To prevent electric shock, do not remove cover. No user serviceable parts inside. Refer servicing to qualified service personnel.
- 3) Do not remove the earthing pin on the power plug. This apparatus is equipped with a three pin earthing-type power plug. This plug will only fit an earthing-type power outlet. This is a safety feature. If you are unable to insert the plug into the outlet, contact an electrician.
Do not defeat the purpose of the earthing plug.
- 4) To prevent electric shock, ensure the earthing pin on the AC cord power plug is securely connected.

CAUTION

This appliance is intended for use in environments which are relatively free of electromagnetic fields.

Using this appliance near sources of strong electromagnetic fields or where electrical noise may overlap with the input signals could cause the picture and sound to wobble or cause interference such as noise to appear.

To avoid the possibility of harm to this appliance, keep it away from sources of strong electromagnetic fields.

WARNING:

This equipment is compliant with Class A of CISPR32. In a residential environment this equipment may cause radio interference.

IMPORTANT INFORMATION: Stability Hazard

Never place a display in an unstable location. A display may fall, causing serious personal injury or death. Many injuries, particularly to children, can be avoided by taking simple precautions such as:

- Using cabinets or stands recommended by the manufacturer of the display.
- Only using furniture that can safely support the display.
- Ensuring the display is not overhanging the edge of the supporting furniture.
- Not placing the display on tall furniture (for example, cupboards or bookcases) without anchoring both the furniture and the display to a suitable support.
- Not placing the display on cloth or other materials that may be located between the display and supporting furniture.
- Educating children about the dangers of climbing on furniture to reach the display or its controls.

If the existing display is going to be retained and relocated, the same considerations as above should be applied.

**IMPORTANT: THE MOULDED PLUG
FOR YOUR SAFETY, PLEASE READ THE
FOLLOWING TEXT CAREFULLY.**

This display is supplied with a moulded three pin mains plug for your safety and convenience. A 10 amp fuse is fitted in this plug. Shall the fuse need to be replaced, please ensure that the replacement fuse has a rating of 10 amps and that it is approved by ASTA or BSI to BS1362.

Check for the ASTA mark  or the BSI mark  on the body of the fuse.

If the plug contains a removable fuse cover, you must ensure that it is refitted when the fuse is replaced.

If you lose the fuse cover the plug must not be used until a replacement cover is obtained.

A replacement fuse cover can be purchased from your local Panasonic dealer.

Do not cut off the mains plug.

Do not use any other type of mains lead except the one supplied with this display.

The supplied mains lead and moulded plug are designed to be used with this display to avoid interference and for your safety.

If the socket outlet in your home is not suitable, get it changed by a qualified electrician.

If the plug or mains lead becomes damaged, purchase a replacement from an authorized dealer.

WARNING : — THIS DISPLAY MUST BE EARTHED

How to replace the fuse.

Open the fuse compartment with a screwdriver and replace the fuse.

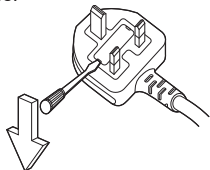

Safety Precautions

WARNING

■ Setup

This LCD Display is for use only with the following optional accessories.

Use with any other type of optional accessories may cause instability which could result in the possibility of injury.

Securely install the pedestal and wall hanging bracket of the optional accessories. Ask an authorized dealer for installation.

The following number of people are required for installation.

98-inch model 86-inch model 75-inch model :
4 or more

65-inch model 55-inch model 49-inch model :
2 or more

- Pedestal
TY-ST75PE9 (75-inch model)
TY-ST55PE9 (65-inch model 55-inch model)
TY-ST43PE9 (49-inch model)
- Wall hanging bracket*1
TY-WK98PV1
(98-inch model 86-inch model 75-inch model
65-inch model)
- 3G-SDI Terminal Board*2
TY-SB01SS
- Digital Interface Box
ET-YFB100G
- DIGITAL LINK Switcher
ET-YFB200G
- Early Warning Software
(Basic license/3-year license):
ET-SWA100 series*3
- Video Wall Manager
Auto Display Adjustment Upgrade Kit
TY-VUK10*4

*1: This product can be purchased in the U.S. and Japan.

*2: This terminal board is supported only when the main software version of the display is 3.5000 or later and the sub software version of the display is 03.50 or later.

For update, please contact your Panasonic dealer.

*3: Suffix of the part number may differ depending on the license type.

*4: 98-inch model 86-inch model
Supports Ver.1.10 or later.

75-inch model
Supports Ver.1.12.1 or later.

65-inch model 55-inch model 49-inch model
Supports Ver.1.11 or later.

Note

- The part number of the optional accessories are subject to change without notice.

When installing the pedestal or wall hanging bracket, read the operating instructions supplied with it carefully and install properly. Also, always use the overturn prevention accessories.

We are not responsible for any product damage, etc. caused by failures in the installation environment for the pedestal or wall hanging bracket even during the warranty period.

Small parts can present choking hazard if accidentally swallowed. Keep small parts away from young children. Discard unneeded small parts and other objects, including packaging materials and plastic bags/sheets to prevent them from being played with by young children, creating the potential risk of suffocation.

Do not place the Display on sloped or unstable surfaces, and ensure that the Display does not hang over the edge of the base.

- The Display may fall off or tip over.

Install this unit at a location with minimal vibration and which can support the weight of the unit.

- Dropping or falling of the unit may cause injury or malfunction.

Caution - For use only with UL Listed Wall Mount Bracket with minimum weight/load 90.0 kg (198.5 lbs).

When installing the display vertically, be sure that the power indicator comes to the right side.

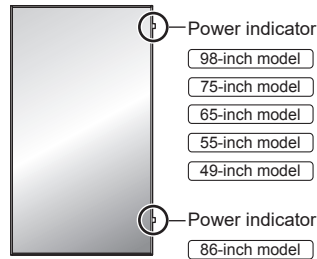

- If installed in different directions, heat is generated and it may cause fire or damage to the Display.

When installing the unit (65-inch model 55-inch model 49-inch model) with its liquid crystal panel facing upright, ask your local Panasonic dealer.

For 98/86/75-inch models, do not position the unit with its liquid crystal panel facing upright.

- There are conditions of mounting method, environmental temperature, connections and settings. If installed in different conditions, heat is generated and it may cause fire or damage to the Display.

Cautions for Wall or Pedestal Installation

- The installation should be performed by an installation professional. Installing the Display incorrectly may lead to an accident that results in death or serious injury. Use the optional Pedestal. (see page 8)

- When installing on a wall, the specified wall hanging bracket (optional accessory) or a wall hanging bracket that conforms to VESA standards must be used.

98-inch model: VESA 800 × 500

86-inch model 75-inch model: VESA 600 × 400

65-inch model 55-inch model 49-inch model:

VESA 400 × 400

(see page 11)

- Before installation, be sure to check if the mounting location has enough strength to support the weight of the display and the wall hanging bracket for anti drop.
- If you terminate the use of the product, ask a professional to remove it promptly.
- When mounting the Display on the wall, prevent the mounting screws and power cable from contacting metal objects inside the wall. An electric shock may occur if they contact metal objects inside the wall.

■ When using the LCD Display

The Display is designed to operate on 110 – 240 V AC, 50/60 Hz.

If problems or malfunction occur, stop using immediately.

If problems occur, unplug the power supply plug.

- Smoke or an abnormal odour come out from the unit.
- No picture appears or no sound is heard, occasionally.
- Liquid such as water or foreign objects got inside the unit.
- The unit has deformed or broken parts.

If you continue to use the unit in this condition, it could result in fire or electric shock.

- Unplug the power supply plug from the wall outlet, and then contact the dealer for repairs.
- To cut off the power supply to this Display completely, you need to unplug the power supply plug from the wall outlet.
- Repairing the unit yourself is dangerous, and shall never be done.
- To enable to unplug the power supply plug immediately, use the wall outlet which you can reach easily.

Do not touch the unit directly by hand when it is damaged.

- Electric shock could occur.

Do not stick any foreign objects into the Display.

- Do not insert any metal or flammable objects into the ventilations holes or drop them onto the Display, as doing so can cause fire or electric shock.

Do not remove the cover (cabinet) or modify it.

- High voltages which can cause fire or electric shocks are present inside the Display. For any inspection, adjustment and repair work, please contact your local Panasonic dealer.

Ensure that the mains plug is easily accessible.

The mains plug shall be connected to a mains socket outlet with a protective earthing connection.

Do not use any power supply cord other than that provided with this unit.

- Doing so may cause short-circuit, generates heat, etc., which could cause electric shock or fire.

Do not use the supplied power supply cord with any other devices.

- Doing so may cause short-circuit, generates heat, etc., which could cause electric shock or fire.

Clean the power supply plug regularly to prevent it becoming dusty.

- If there is a build up of dust on the plug, the resultant humidity may cause short-circuit, which could cause electric shock or fire. Unplug the power supply plug from the wall outlet and wipe it with a dry cloth.

Do not handle the power supply plug with wet hands.

- Doing so may cause electric shocks.

Securely insert the power supply plug (socket outlet side) and the power supply connector (main unit side) as far as it will go.

- If the plug is not fully inserted, heat may be generated which could cause fire. If the plug is damaged or the wall socket is loose, they shall not be used.

Do not do anything that may damage the power supply cord or the power supply plug.

- Do not damage the cable, make any modifications to it, place heavy objects on top of it, heat it, place it near any hot objects, twist it, bend it excessively or pull it. To do so may cause fire and electric shock. If the power cable is damaged, have it repaired at your local Panasonic dealer.

Do not touch the power supply cord or the plug directly by hand when they are damaged.

- Doing so may cause electric shock or fire due to short-circuit.

Keep the supplied AAA/R03/LR03 batteries, M4 screw and washer out of reach of children. If accidentally swallowed, it will be harmful to the body.

- Please contact a doctor immediately in case you doubt that the child may have swallowed it.

To prevent the spread of fire, keep candles or other open flames away from this product at all times.



CAUTION

Do not place any objects on top of the Display.

Ventilation should not be impeded by covering the ventilation openings with items such as newspapers, table cloths and curtains.

- Doing so may cause the Display to overheat, which can cause fire or damage to the Display.

For sufficient ventilation, see page 11.

Do not place the display where it may be affected by salt or corrosive gas.

- Doing so may cause the display to fall due to corrosion, and it may result in injury. Also, the unit may malfunction.

The following number of people are required to carry or unpack this unit.

(98-inch model) (86-inch model) (75-inch model) :

4 or more

(65-inch model) (55-inch model) (49-inch model) :

2 or more

- If this is not observed, the unit may drop, resulting in injury.

When disconnecting the power supply cord, always pull on the plug (socket outlet side) / the connector (main unit side).

- Pulling the cord may damage the cord, and it may cause electric shock or fire due to short-circuit.

Be sure to disconnect all cables and overturn prevention accessories before moving the Display.

- If the Display is moved while some of the cables are still connected, the cables may become damaged, and fire or electric shock could result.

Disconnect the power supply plug from the wall socket as a safety precaution before carrying out any cleaning.

- Electric shocks can result if this is not done.

Do not step on, or hang from the display or the Pedestal.

- They might tip over, or might be broken and it may result in injury. Pay special attention to the children.

Do not reverse the polarity (+ and -) of the battery when inserting.

- Mishandling the battery may cause its explosion or leakage, resulting in fire, injury or damage to surrounding properties.
- Insert the battery correctly as instructed. (see page 14)

Do not use batteries with the outer cover peeling away or removed.

- Mishandling the batteries may cause the batteries to short circuit, resulting in fire, injury or damage to surrounding properties.

Remove the batteries from the remote control transmitter when not using for a long period of time.

- The battery may leak, heat, ignite or burst, resulting in fire or damage to surrounding properties.

Remove exhausted batteries from the remote control immediately.

- Leaving the batteries unattended in it may cause battery leakage, heat or burst.

Do not burn or breakup batteries.

- Batteries must not be exposed to excessive heat such as sunshine, fire or the like.

Do not turn the Display upside down.

Do not position the unit with its liquid crystal

panel facing upright. (98-inch model) (86-inch model)

(75-inch model) **only**)

Precautions for use

Cautions when installing

Do not set up the Display outdoors.

- The Display is designed for indoor use.

Install this unit at a location which can support the weight of the unit.

- Dropping or falling of the unit may cause injury.

Environmental temperature to use this unit

- When using the unit where it is below 1 400 m (4 593 ft) above sea level: 0 °C to 40 °C (32 °F to 104 °F)
- When using the unit at high altitudes (1 400 m (4 593 ft) and higher and below 2 800 m (9 186 ft) above sea level): 0 °C to 35 °C (32 °F to 95 °F)

Do not install the unit where it is 2 800 m (9 186 ft) and higher above sea level.

- Failure to do so may shorten the life of the internal parts and result in malfunctions.

When installing the unit (65-inch model)

(55-inch model) (49-inch model) with its liquid crystal panel facing upright, ask your local Panasonic dealer.

For 98/86/75-inch models, do not position the unit with its liquid crystal panel facing upright.

- There are conditions of mounting method, environmental temperature, connections and settings.

We are not responsible for any product damage, etc. caused by failures in the installation environment even during the warranty period.

Transport only in upright position!

- Transporting the unit with its liquid crystal panel facing upright or downward may cause damage to the internal circuitry.

Do not grab the liquid crystal panel.

- Do not forcibly press the liquid crystal panel, or push it with a pointed object. Applying a strong force to the liquid crystal panel will cause unevenness of the screen display, resulting in malfunction.

Do not install the product to a place where the product is exposed to direct sunlight.

- If the unit is exposed to direct sunlight even indoors, the temperature rise of the liquid crystal panel may cause malfunction.

Required space for ventilation

- Operation of this unit is guaranteed up to an ambient temperature of 40 °C (104 °F). When installing the unit in a case or chassis, be sure to provide adequate ventilation with a cooling fan or ventilation hole so that the surrounding temperature (inside the case or chassis) including the temperature of the front surface of the liquid crystal panel can be kept at 40 °C (104 °F) or less.

About the screws used when using a wall hanging bracket that conforms to VESA standards

| Inch model | Screw pitch for installation | Depth of screw hole | Screw (quantity) |
|------------|------------------------------|---------------------|------------------|
| 98 | 800 mm × 500 mm | 13 mm | M8 (4) |
| 86 | 600 mm × 400 mm | 13 mm | M8 (4) |
| 75 | 600 mm × 400 mm | 10 mm | M6 (4) |
| 65 | 400 mm × 400 mm | 11 mm | M6 (4) |
| 55 | | | |
| 49 | | | |

Note for connection

Removing and inserting the power cord and connection cables

- When the unit has been installed on the wall, if the power cord and connection cables are difficult to remove and insert, make connections first before installation. Be careful not to allow the cables to be entangled. After installation is completed, insert the power plug to the outlet.

When using

Be careful of the movable structure of the power indicator and remote control sensor.

- As factory default, the power indicator and remote control sensor are stored in the main unit. For normal use, pull out the remote control sensor from the edge side of the main unit by operating the lever on the rear panel. Depending on the setup condition such as when using multi screen display of the multi display, store the remote control sensor in the main unit. (see page 32)

Red, blue or green dots on the screen are a liquid crystal panel-specific phenomenon. This is not a malfunction.

- Although the liquid crystal display is manufactured with high-precision technology, always-lighting dots or non-lighting dots may appear on the screen. This is not a malfunction.

| Inch model | Dot omission ratio* |
|------------|---------------------|
| 98 | 0.00007% or less |
| 86 | 0.00007% or less |
| 75 | 0.00006% or less |
| 65 | 0.00006% or less |
| 55 | 0.00004% or less |
| 49 | 0.00004% or less |

*: Calculated in sub-pixel units according to the ISO9241-307 standard.

Depending on the temperature or humidity conditions, uneven brightness may be observed. This is not a malfunction.

- This unevenness will disappear while applying current continuously. If not, consult the distributor.

If the Display is not going to be used for any prolonged length of time, unplug the power supply plug from the wall outlet.

Picture noise may occur if you connect / disconnect the cables connected to the input terminals you are currently not watching, or if you turn the power of the video equipment on / off, but it is not a malfunction.

Notes on Using Wired LAN

When setting up the Display at a place, where electric static occurs often, take a sufficient antistatic measure before start using.

- When the Display is used at a location, where static electricity occurs often, such as on a carpet, a wired LAN or DIGITAL LINK communication is disconnected more often. In that case, remove static electricity and the noise source that may cause problems with an antistatic mat, and re-connect the wired LAN or DIGITAL LINK.
- In rare cases, the LAN connection is disabled due to static electricity or noise. In that case, turn off the power of the Display and the connected devices once and then re-turn on the power.

The Display may not work properly due to strong radio wave from the broadcast station or the radio.

- If there is any facility or equipment, which outputs strong radio wave, near the installation location, set up the Display at a location sufficiently far from the source of the radio wave. Or, wrap the LAN cable connected to the DIGITAL LINK / LAN terminal by using a piece of metal foil or a metal pipe, of which is grounded at both ends.

Request Regarding Security

When using this unit, take safety measures against the following incidents.

- Personal information being leaked via this unit
- Unauthorized operation of this unit by a malicious third party
- Interfering or stopping of this unit by a malicious third party

Take sufficient security measures. (see page 101, 107)

- Set a password for the LAN control and restrict the users who can log in.
- Make your password difficult to guess as much as possible.
- Change your password periodically.
- Panasonic Corporation or its affiliate companies will never ask for your password directly. Do not divulge your password in case you receive such inquiries.
- The connecting network must be secured by a firewall, etc.
- When disposing the product, initialize the data before disposing. ([Shipping] (see page 141))

Cleaning and maintenance

First, remove the mains plug from the mains socket.

Gently wipe the surface of the liquid crystal panel or cabinet by using a soft cloth to remove dirt.

- To remove stubborn dirt or fingerprints on the surface of the liquid crystal panel, dampen a cloth with diluted neutral detergent (1 part detergent to 100 parts water), wring out the cloth firmly, and then wipe away the dirt. Finally, wipe away all the moisture with a dry cloth.
- If water droplets get inside the unit, operating problems may result.

Note

- The surface of the liquid crystal panel is specially treated. Do not use a hard cloth or rub the surface too hard, otherwise this may cause scratches on the surface.

Usage of a chemical cloth

- Do not use a chemical cloth for the liquid crystal panel surface.
- Follow the instructions for the chemical cloth to use it for the cabinet.

Avoid contact with volatile substances such as insect sprays, solvents and thinner.

- This may cause damage to the cabinet or cause peeling of the paint. Furthermore, do not leave it in contact with a rubber or PVC substance for a long time.

Disposal

When disposing the product, ask your local authority or dealer about the correct methods of disposal.

Accessories

Accessories Supply

Check that you have the accessories and items shown.

Remote Control Transmitter × 1

- DPVF2713ZA/X1



Batteries for the Remote Control Transmitter × 2 (AAA/R03/LR03 type)

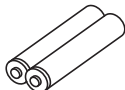

Clamper × 3

- DPVF1056ZA



USB memory cover × 1

98-inch model

86-inch model

75-inch model

65-inch model

55-inch model

- DPVF2281ZA/X1

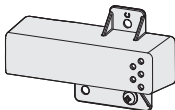

49-inch model

- DPVF2280ZA/X1

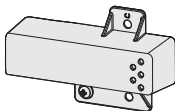

SLOT adapter × 1

- DPVF2389ZA/X1

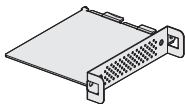

Power supply cord

(Approx. 2 m)

- 1JP155AF1U

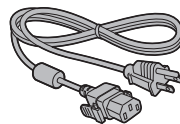

- 1JP155AF1W

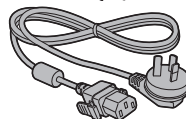

- 2JP155AF1W

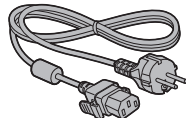

- 3JP155AF1W

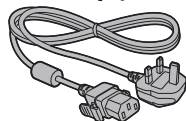

Attention

- Store small parts in an appropriate manner, and keep them away from young children.
- The part numbers of accessories are subject to change without notice. (The actual part number may differ from the ones shown above.)
- In case you lost accessories, please purchase them from your dealer. (Available from the customer service)
- Dispose the packaging materials appropriately after taking out the items.

Remote Control Batteries

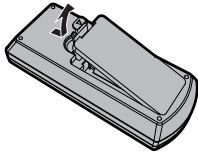

Open the battery cover.

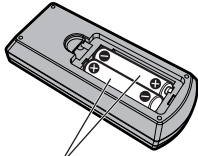

Insert batteries and close the battery cover.

(Insert starting from the  side.)

AAA/R03/LR03 type

Note

- Incorrect installation of the batteries can cause battery leakage and corrosion that will damage the remote control.
- Disposal of batteries should be done in an environment-friendly manner.

Take the following precautions.

1. Batteries shall always be replaced as a pair.
2. Do not combine a used battery with a new one.
3. Do not mix battery types (example; manganese dioxide battery and alkaline battery etc.).
4. Do not attempt to charge, disassemble or burn used batteries.
5. Do not burn or breakup batteries.
Moreover, batteries must not be exposed to excessive heat such as sunshine, fire or the like.

Attaching the USB Memory Cover

When using a USB memory device, the USB memory cover can be attached to protect the device.

Attach the USB memory cover using any of the following screw positions corresponding to the type of model.

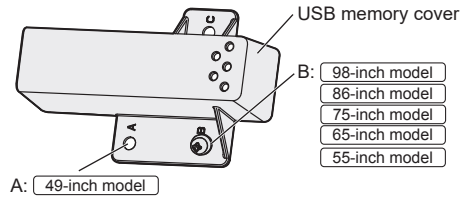

1 Insert the USB memory device to the USB terminal on the bottom of the display.

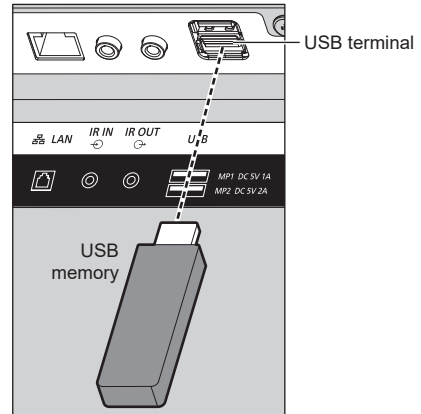

Note

- Select the USB terminal to be used with [USB select]. (see page 90)
- Depending on the USB terminal, the amount of electricity supplied to an external device differs. ("USB terminal connection", see page 30)

2 Attach the USB memory cover, aligning the M4 screw with the screw hole of the display unit.

3 Tighten the M4 screw to fix the USB memory cover.

A: 49-inch model

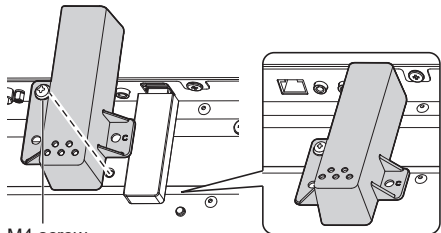

M4 screw

B: 98-inch model 86-inch model 75-inch model
65-inch model 55-inch model

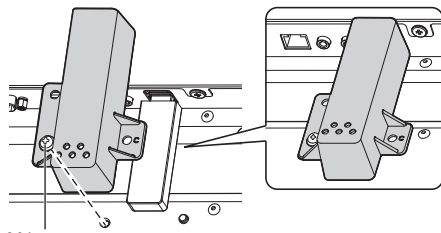

M4 screw

Attaching the Function Board

When using a narrow-width function board, attach the supplied SLOT adaptor, and insert it to the slot.

Note

- Before attaching or removing the function board, be sure to turn off the power of the display and remove the power plug from the outlet.

When attaching a full-size function board, proceed to step 4.

1 Remove one screw from the side with the guide on the SLOT adaptor.

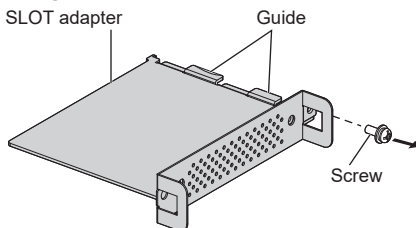

2 Fit the circuit board of the function board in the guides of the SLOT adaptor, and bring the circuit board into contact with the hook (one location) and the end faces (two locations) securely.

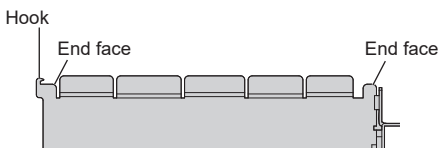
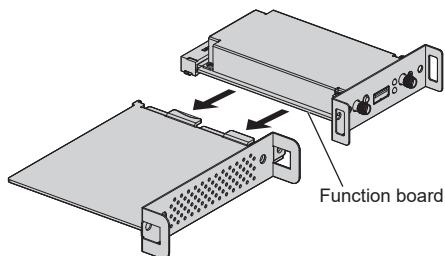

3 Using the screw removed in step 1, fix the function board to the SLOT adaptor.

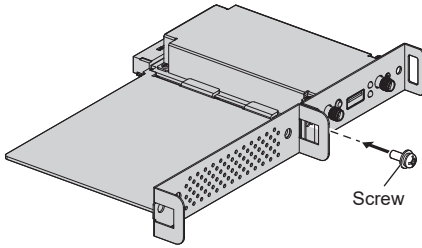

- Tightening torque guideline: 0.5 N·m or less

Note

- Firmly tighten the screw, and check that the hook of the SLOT adaptor fixes the circuit board.
- Check that the surface of the SLOT adaptor and the surface of the circuit board match with each other when the function board with the SLOT adaptor attached is viewed from the opposite side of the cover.

Make sure that this side is aligned.

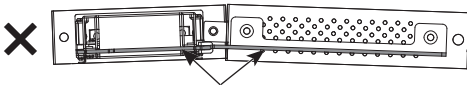
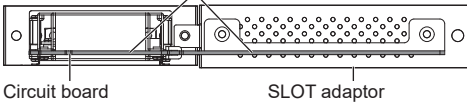

It cannot be attached unless this side is horizontally aligned.

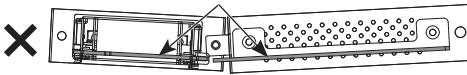

- If there is a lead wire within approx. 3 mm from the end face of the circuit board, the function board cannot be attached due to interference with the guide rail. Ensure that there is no lead wire in this range.

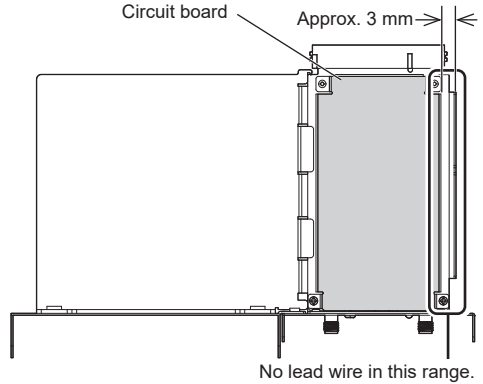

4 Remove the two screws from the main unit slot cover.

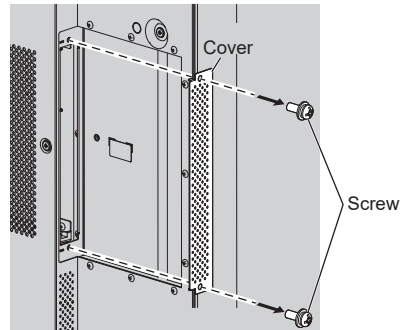

5 Insert the function board to the main unit slot, and fix it with the two screws removed in step 4.

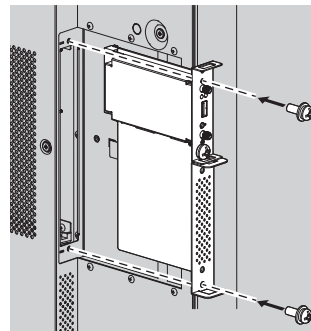

- Tightening torque guideline: 0.5 N·m or less

Cautions when moving

The display has handles for carrying. Hold them when moving.

98-inch model 86-inch model

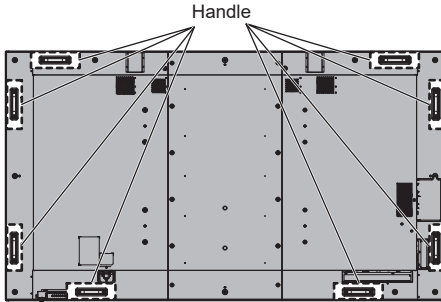

75-inch model

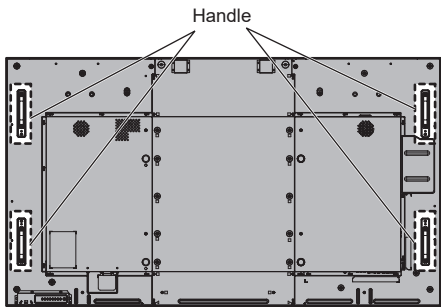

65-inch model

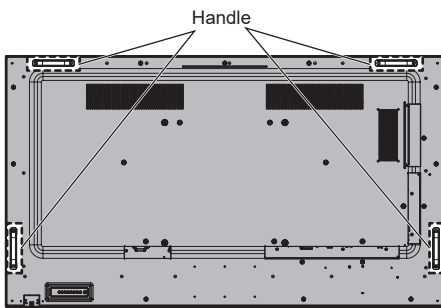

55-inch model 49-inch model

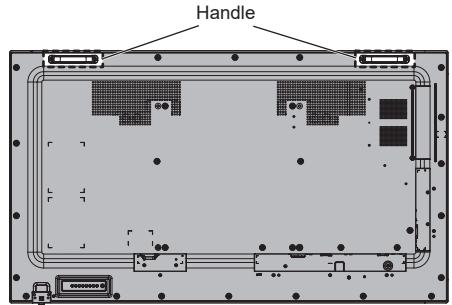

Note

- Do not hold parts other than the handles.
98-inch model 86-inch model 75-inch model
- The following number of people are required to carry this unit.

98-inch model 86-inch model 75-inch model :
4 or more

65-inch model 55-inch model 49-inch model :
2 or more

If this is not observed, the unit may drop, resulting in injury.

- When carrying the unit, keep the liquid crystal panel upright.
Carrying the unit with the surface of the liquid crystal panel facing up or down may cause deformation of the panel, or internal damage.
- Do not hold the upper, lower, right and left frames or the corners of the unit. Do not hold the front surface of the liquid crystal panel. Also, do not hit such parts.
Doing so may damage the liquid crystal panel.
Also, the panel may crack, resulting in injury.

Eyebolt

98-inch model

86-inch model

75-inch model

The display has holes for attaching eyebolts (M10). When installing, use them to suspend the display.

Use the eyebolt only for temporary suspension or movement for installation. This cannot be used for permanent hanging installation.

Eyebolt (commercially available) mounting positions

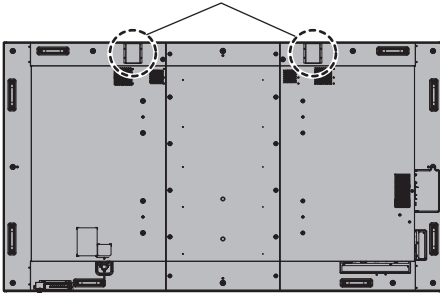

- 1 When attaching the eyebolt, remove the eyebolt cap from the eyebolt mounting position (two locations), and leave the flat washer (black) as it is.**

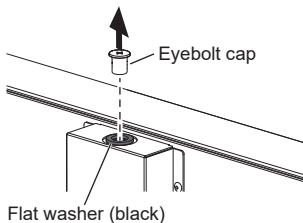

- 2 Attach the eyebolt with the flat washer (black) left as it is.**

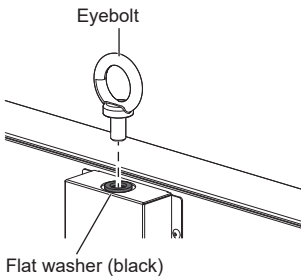

- 3 After removing the eyebolt, tighten the eyebolt cap with the flat washer (black) left as it is.**

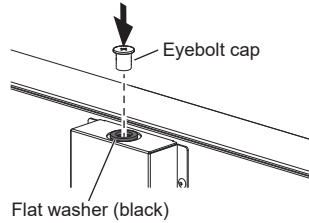

Note

- Installation should be performed by an installation professional.
- Do not suspend using only 1 eyebolt.
- Use commercially sold M10 eyebolts with a shank length of 12 mm to 40 mm that satisfies the load condition of product quality.
- Use ISO 3266 standard eyebolts. Also use ISO standard members (wire, etc.) for hanging.
- The hanging angle should be 60° or more.
- After installation, remove the eyebolts, and close the holes using the eyebolt caps removed when attaching the eyebolts.

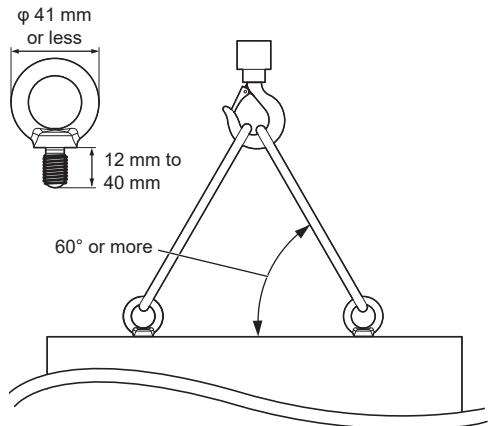

Connections

AC cord connection and fixing / Cable fixing

Back of the unit

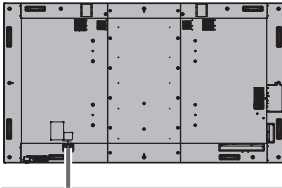

AC cord fixing

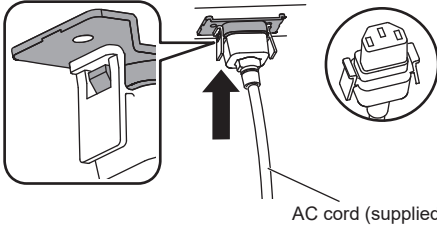

Plug the connector into the display unit.

Plug the connector until it clicks.

Note

- Make sure that the connector is locked on both the left and right sides.

Unplug the AC cord

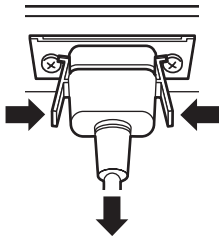

Unplug the connector pressing the two knobs.

Note

- Do not use an AC cord of which the knobs are damaged. If it is used with the knobs damaged, a bad connection may result between the AC cord connector and the AC IN terminal. For the repair of the AC cord, consult the dealer where you purchased the product.
- When disconnecting the AC cord, be absolutely sure to disconnect the AC cord plug at the socket outlet first.
- The supplied AC cord is for this unit exclusive use. Do not use this for other purposes.

Cable fixing

Note

- 3 clampers are supplied with this unit. Fix the cables at 3 locations using the holes for clampers as shown below.
- Before turning the power on, stop the holes (3 locations) with the clampers. Otherwise, foreign objects may enter the holes, resulting in a fire.
 - If you need more clampers, purchase them from your dealer. (Available from the customer service)

98-inch model

Holes for attaching the clampers

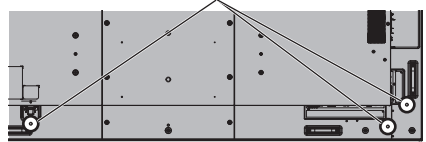

86-inch model

Holes for attaching the clampers

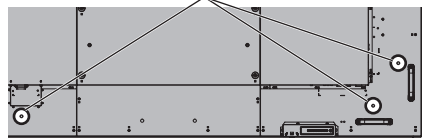

75-inch model

Holes for attaching the clampers

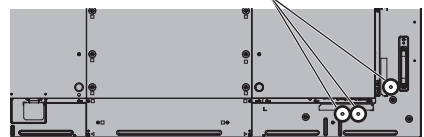

65-inch model

Holes for attaching the clampers

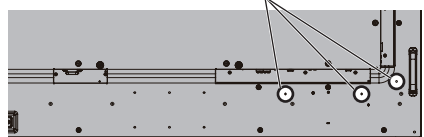

55-inch model

Holes for attaching the clampers

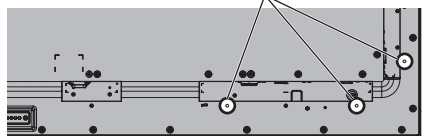

49-inch model

Holes for attaching the clampers

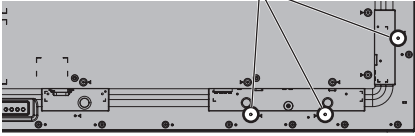

1. Attach the clammer

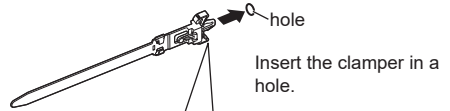

To remove from the unit:

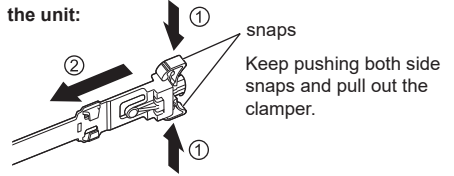

2. Bundle the cables

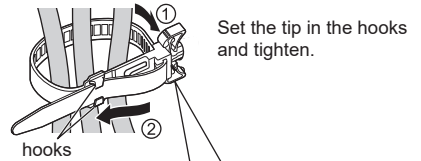

To loosen:

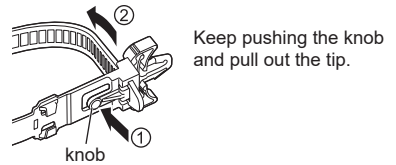

Video equipment connection

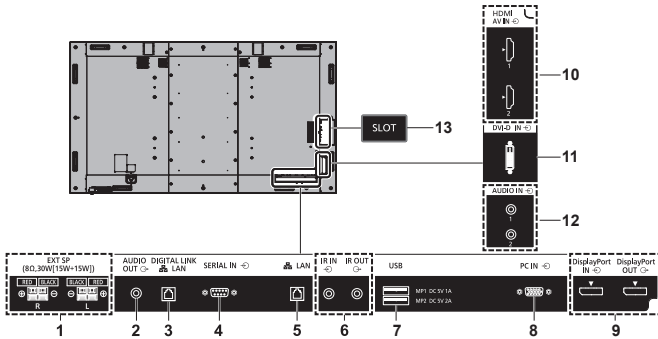

1 EXT SP: **Speaker Terminal**
Connect to external speaker.
(see page 31)

2 AUDIO OUT: **Analogue Audio Output Terminal**
Connect to audio equipment with analogue audio input terminal.
(see page 30)

3 DIGITAL LINK / LAN: **DIGITAL LINK / LAN Terminal**
Control the Display by connecting to Network. Alternatively, connect to a device that sends video and audio signals via the DIGITAL LINK terminal.
(see page 27, 91)

4 SERIAL IN: **SERIAL Input Terminal**
Control the Display by connecting to PC.
(see page 28)

5 LAN: **LAN Terminal**
Control the Display by connecting to Network.
(see page 91)

6 IR IN, IR OUT: **Infrared Signal Input / Output Terminal**
Use this when operating more than one display with one remote control.
(see page 29)

7 USB: **USB Terminal (2 systems)**
Connect the USB memory to use "USB media player" or "Memory viewer". Also, this can be used to supply power of up to 5V/1A (front side terminal) or 5V/2A (far side terminal) to an external device when the picture is displayed.
(see page 30)

8 PC IN: **PC Input Terminal**
Connect to video terminal of PC, video equipment with "YPbPr / YCbCr" or "RGB" output.
(see page 24)

9 DisplayPort IN, DisplayPort OUT: **DisplayPort Input / Output Terminal (Supports 4K picture)**
Connect to PC or video equipment with DisplayPort terminal. (see page 25)

10 AV IN (HDMI 1, HDMI 2): **HDMI Input Terminal (2 systems)**
Connect to video equipment with HDMI output.
(see page 22)

11 DVI-D IN: **DVI-D Input Terminal**
Connect to video equipment with DVI-D output.
(see page 23)

12 AUDIO IN 1, AUDIO IN 2: **Analogue Audio Input Terminal (2 systems)**
(see page 23, 24)

13 SLOT: **Expansion slot**
(see page 15)

Note

- For the compatible function board, consult the dealer where you purchased the product.

Before connecting

- Before connecting cables, carefully read the operating instructions for the external device to be connected.
- Turn off the power of all devices before connecting cables.
- Take note of the following points before connecting the cables. Failure to do so may result in malfunctions.
 - When connecting a cable to the unit or a device connected to the unit itself, touch any nearby metallic objects to eliminate static electricity from your body before performing work.
 - Do not use unnecessarily long cables to connect a device to the unit or to the unit body. The longer the cable, the more susceptible to noise it becomes. Since using a cable while it is wound makes it act like an antenna, it is more susceptible to noise.
 - When connecting cables, insert them straight into the connecting terminal of the connecting device so that the ground is connected first.
- Acquire any cable necessary to connect the external device to the system that is neither supplied with the device nor available as an option.
- If the outer shape of the plug of a connection cable is large, it may come in contact with the periphery such as a back cover or the plug of an adjacent connection cable. Use a connection cable with the suitable plug size for the terminal alignment.
- When connecting the LAN cable with plug cover, be aware that the cover may come in contact with the back cover and it may be difficult to disconnect.
- If video signals from video equipment contain too much jitter, the images on the screen may wobble. In this case, a time base corrector (TBC) must be connected.
- When the sync signals output from PC or video equipment are disturbed, for example, when changing settings of video output, the colour of the video may be disturbed temporarily.
- The unit accepts YPbPr/YCbCr signals (PC IN), analogue RGB signals (PC IN) and digital signals.
- Some PC models are not compatible with the unit.
- Use cable compensator when you connect devices to the unit using long cables. Otherwise the image may not be displayed properly.
- Refer to "Preset Signals" (see page 138) for the types of video signals that can be displayed with the unit.
- The DIGITAL LINK / LAN terminal and the LAN terminal are connected inside this unit. When using both the DIGITAL LINK / LAN terminal and the LAN terminal, configure the system in such a way that they are not connected to the same network directly or via peripheral devices such as hub and twist pair cable transmitter.

HDMI 1 and HDMI 2 terminals connection

Note

- Video equipment and HDMI cable shown are not supplied with this unit.
- Connect the equipment complying with the HDMI standard.
- Some HDMI equipment may not be able to display picture.
- This Display does not support VIERA LINK.
- For audio, it is also possible to use the AUDIO IN 1 / AUDIO IN 2 terminal. (For [Audio input select] function, see page 71.)
- Use an HDMI High Speed cable complying with the HDMI standards.

Note when inputting 4K video signals exceeding the transmission speed supported by an HDMI High Speed cable, use an HDMI cable supporting 18 Gbps high-speed transmission such as the one certified as a Premium HDMI cable.

When inputting video signals exceeding the transmission speed supported by the HDMI cable you are using, malfunction may occur such as interrupted pictures and no display on the screen.

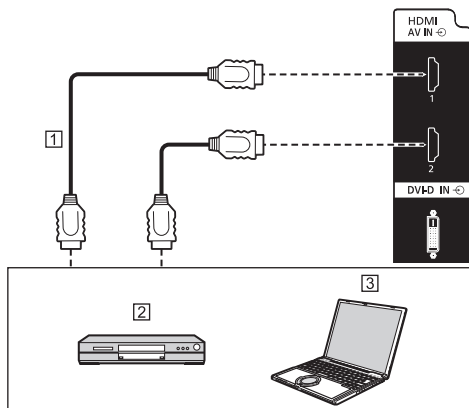

- ① HDMI cable (commercially available)
- ② DVD Player
- ③ PC

Pin assignments and signal names for HDMI Terminal

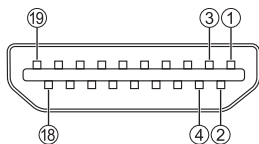

| Pin No. | Signal name |
|---------|----------------------|
| ① | T.M.D.S Data2 + |
| ② | T.M.D.S Data2 Shield |
| ③ | T.M.D.S Data2 - |
| ④ | T.M.D.S Data1 + |
| ⑤ | T.M.D.S Data1 Shield |
| ⑥ | T.M.D.S Data1 - |
| ⑦ | T.M.D.S Data0 + |
| ⑧ | T.M.D.S Data0 Shield |
| ⑨ | T.M.D.S Data0 - |
| ⑩ | T.M.D.S Clock + |
| ⑪ | T.M.D.S Clock Shield |
| ⑫ | T.M.D.S Clock - |
| ⑬ | CEC |
| ⑭ | |
| ⑮ | SCL |
| ⑯ | SDA |
| ⑰ | DDC/CEC Ground |
| ⑱ | +5V DC |
| ⑲ | Hot Plug Detect |

DVI-D IN terminal connection

Note

- Video equipment and cables shown are not supplied with this unit.
- DVI-D IN terminal is for Single Link only.
- For audio, the AUDIO IN 1 / AUDIO IN 2 terminal can be used. (For [Audio input select] function, see page 71.)
- Use the DVI-D cable complying with the DVI standard. (Depending on the cable length or its quality, noise may occur on images, or the image quality may deteriorate.)

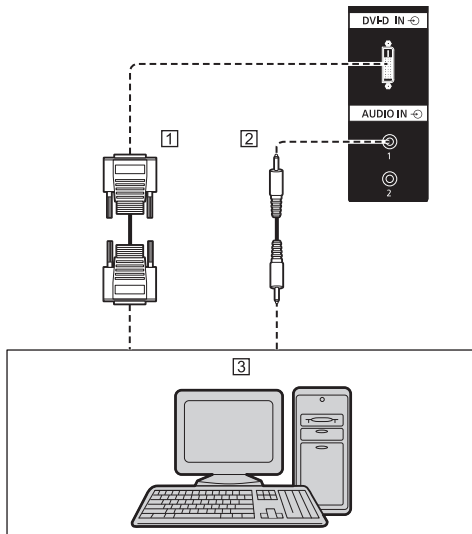

- ① DVI-D cable (within 5 m) (commercially available)
- ② Stereo mini plug (M3) cable (commercially available)
- ③ PC with DVI-D out

Pin assignments and signal names for DVI-D Input/Output

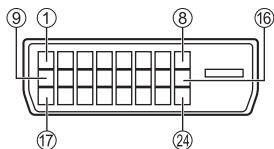

| Pin No. | Signal Name |
|---------|------------------------|
| ① | T.M.D.S. data 2 - |
| ② | T.M.D.S. data 2 + |
| ③ | T.M.D.S. data 2 shield |
| ④ | _____ |
| ⑤ | _____ |
| ⑥ | DDC clock |
| ⑦ | DDC data |
| ⑧ | _____ |
| ⑨ | T.M.D.S. data 1 - |
| ⑩ | T.M.D.S. data 1 + |
| ⑪ | T.M.D.S. data 1 shield |
| ⑫ | _____ |
| ⑬ | _____ |
| ⑭ | +5 V DC |
| ⑮ | GND (Ground) |
| ⑯ | Hot plug detect |
| ⑰ | T.M.D.S. data 0 - |
| ⑱ | T.M.D.S. data 0 + |
| ⑲ | T.M.D.S. data 0 shield |
| ⑳ | _____ |
| ㉑ | _____ |
| ㉒ | T.M.D.S. clock shield |
| ㉓ | T.M.D.S. clock + |
| ㉔ | T.M.D.S. clock - |

PC IN terminal connection

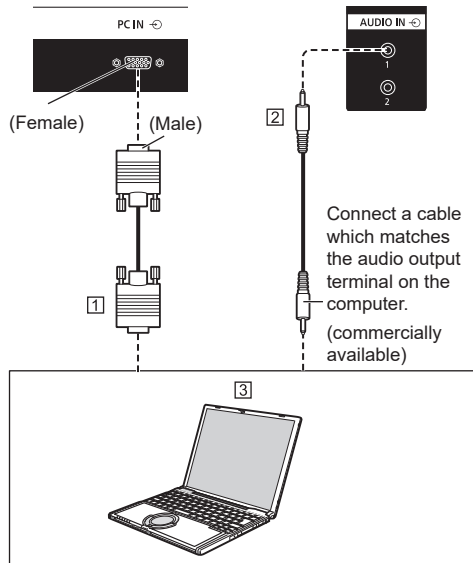

- ① Mini D-sub 15p cable (commercially available)
- ② Stereo mini plug (M3) cable (commercially available)
- ③ PC

The type of computer signal that can be connected

- With regard to the typical PC input signals that are described in “Preset Signals” (see page 138), adjustment values such as for the standard picture positions and sizes have already been stored in this unit.
(Computer signals which can be input are those with a horizontal scanning frequency of 30 to 110 kHz and vertical scanning frequency of 48 to 120 Hz.)
- The display resolution is a maximum of 1 440 x 1 080 dots when the aspect mode is set to [Normal], and 1 920 x 1 080 dots when the aspect mode is set to [Full]. If the display resolution exceeds these maximums, it may not be possible to show fine detail with sufficient clarity.
- If signals outside the range of supported frequencies are input, normal images cannot be displayed. Note that some images may not be correctly displayed even if signals are within the range.
- If the PC screen is not displayed, check if the image signal of the PC meets “Preset Signals” (see page 138), and then change the settings. For power-saving purpose, image output may be OFF on a notebook computer. In this case, it may be set to ON with function key operation etc. of the computer. (Refer to the manual of the computer.)

Note

- Component video signal is supported with this terminal (Mini D-sub 15P).

Change the [Component/RGB-in select] setting in the [Signal] menu to [Component] (when Component signal connection) or [RGB] (when RGB signal connection). (see page 60)

- Additional computer, cables and conversion adaptor shown are not supplied with this set.
- If the computer being connected is not DDC2B-compatible, you will need to make setting changes to the computer at the time of connection.
- Do not set the horizontal and vertical scanning frequencies for PC signals which are above or below the specified frequency range.
- For audio, the AUDIO IN 1 / AUDIO IN 2 terminal can be used. (For [Audio input select] function, see page 71.)

Pin assignments and signal names for PC Input Terminal (Mini D-sub 15P)

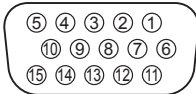

| Pin No. | Signal Name |
|---------|-------------------------------------|
| ① | R (P _R /C _R) |
| ② | G (Y) |
| ③ | B (P _B /C _B) |
| ④ | NC (not connected) |
| ⑤ | GND (Ground) |
| ⑥ | GND (Ground) |
| ⑦ | GND (Ground) |
| ⑧ | GND (Ground) |
| ⑨ | +5 V DC |
| ⑩ | GND (Ground) |
| ⑪ | NC (not connected) |
| ⑫ | SDA |
| ⑬ | HD |
| ⑭ | VD |
| ⑮ | SCL |

DisplayPort IN / DisplayPort OUT terminal connection

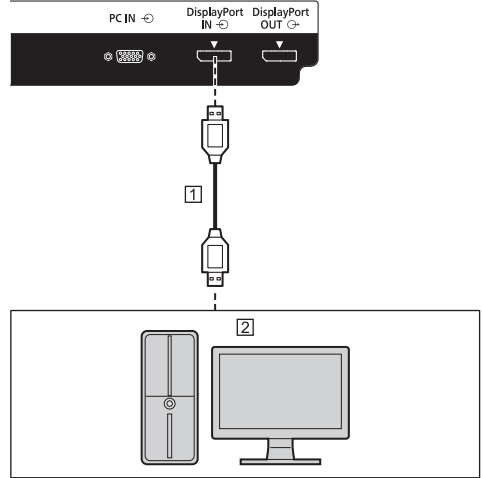

- ① DisplayPort cable (commercially available)
- ② PC with DisplayPort output

Note

- For audio, it is also possible to use the AUDIO IN 1 / AUDIO IN 2 terminal. (For [Audio input select] function, see page 71.)
- Depending on the device to be connected, it may take time for images to be displayed.
- Please use DisplayPort 1.2 compliant cable.
- Depending on the types of cable or mini connector adaptor used, 4K picture may not be displayed.
- In connecting with PC which uses early chipsets or graphic cards compatible with DisplayPort, if the DisplayPort output of the PC is connected to this unit, malfunction of this unit or the PC may occur. In that case, turn the power of the unit or the PC off, and then turn it on again.

When inputting DisplayPort output to this unit, it is recommended to use the PC which the newest Chipset and Graphics Cards are used.

Pin assignments and signal names for DisplayPort

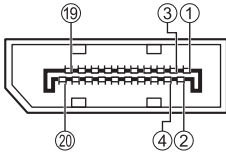

| Pin No. | Signal Name |
|---------|-------------------|
| ① | ML_Lane 3 (n) |
| ② | GND (Ground) |
| ③ | ML_Lane 3 (p) |
| ④ | ML_Lane 2 (n) |
| ⑤ | GND (Ground) |
| ⑥ | ML_Lane 2 (p) |
| ⑦ | ML_Lane 1 (n) |
| ⑧ | GND (Ground) |
| ⑨ | ML_Lane 1 (p) |
| ⑩ | ML_Lane 0 (n) |
| ⑪ | GND (Ground) |
| ⑫ | ML_Lane 0 (p) |
| ⑬ | CONFIG1 |
| ⑭ | CONFIG2 |
| ⑮ | AUX_CH (p) |
| ⑯ | GND (Ground) |
| ⑰ | AUX_CH (n) |
| ⑱ | Hot Plug Detect |
| ⑲ | GND (Ground) |
| ⑳ | + 3.3 V DC output |

Daisy chain connection

It is possible to daisy chain multiple displays when displaying the picture with multi screen display of the multi display, etc.

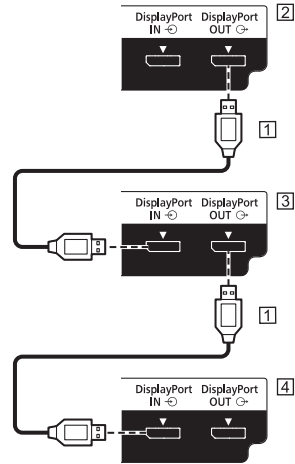

- ① DisplayPort cable (commercially available)
- ② First display
- ③ Second display
- ④ Third display

Note

- The output from the DisplayPort OUT terminal supports only signals input to the DisplayPort IN, HDMI1, HDMI2, DVI-D IN and SLOT terminals.
- When images are not displayed on the subsequent-stage displays, turn on the preceding-stage displays, wait for at least 7 seconds, then turn on the subsequent-stage displays.
e.g.) Set [Power ON screen delay] of the subsequent-stage displays to [7] or more before using.
- The DisplayPort OUT terminal does not support HDCP2.2.

DIGITAL LINK terminal connection

Twisted pair cable transmitters such as the Panasonic Digital Interface Box (ET-YFB100G) or the DIGITAL LINK Switcher (ET-YFB200G) use twisted pair cables to transmit inputted video and audio signals, and these digital signals can be input to the Display via the DIGITAL LINK terminal.

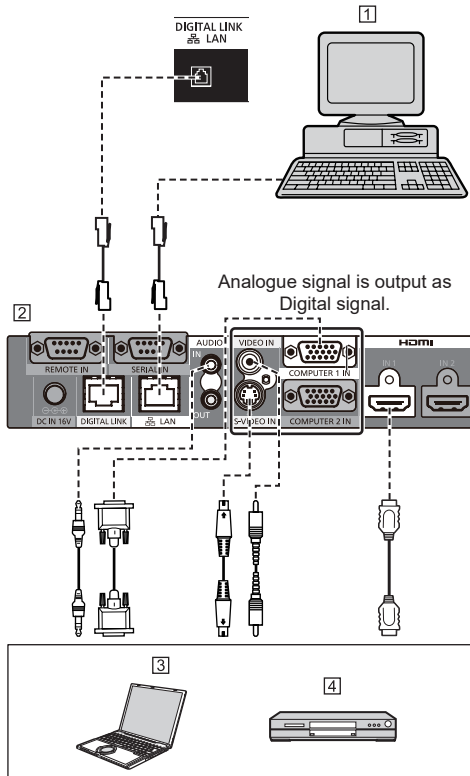

Note

- Video equipment and connection cables are not supplied with this unit.
- When connecting with DIGITAL LINK, be sure to configure each of the [Network settings] settings. (see page 77)
For the cautions for DIGITAL LINK setting and connection, refer to “DIGITAL LINK Terminal connection” and “Precautions for use while connecting with a twisted pair cable transmitter”. (see page 92)
- Corresponding signal for DIGITAL LINK input is the same as that of HDMI input. (see page 138)
- For audio, it is also possible to use the AUDIO IN 1 / AUDIO IN 2 terminal input. (For [Audio input select] function, see page 71.)

SERIAL IN terminal connection

The SERIAL terminal conforms to the RS-232C interface specification, so that the Display can be controlled by a computer which is connected to this terminal.

Note

- Additional computer and cables shown are not supplied with this set.

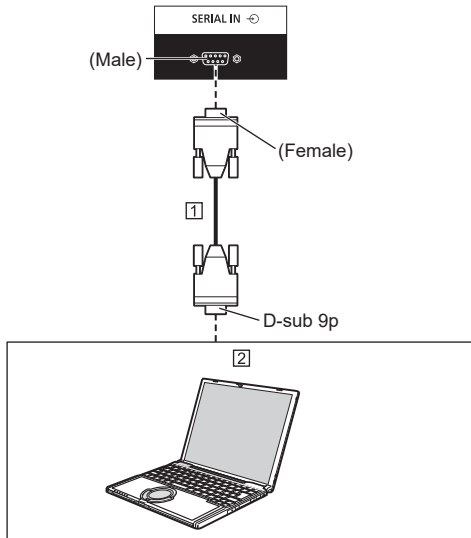

1 RS-232C Straight cable (commercially available)

2 PC

Note

- Select the RS-232C straight cable for communication used for connecting SERIAL terminal and computer according to the computer you are using.

Pin assignments and signal names for SERIAL Terminal

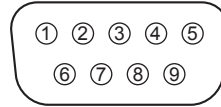

| Pin No. | Signal Name | |
|---------|--------------------|-----------------------|
| ① | NC (not connected) | |
| ② | RXD | |
| ③ | TXD | |
| ④ | Non use | |
| ⑤ | GND (Ground) | |
| ⑥ | Non use | |
| ⑦ | RTS | } Shorted in this set |
| ⑧ | CTS | |
| ⑨ | NC (not connected) | |

These signal names are those of computer specifications.

Communication parameters

Signal level: RS-232C compliant

Synchronization method: Asynchronous

Baud rate: 9 600 bps

Parity: None

Character length: 8 bits

Stop bit: 1 bit

Flow control: None

Basic format for control data

The transmission of control data from the computer starts with a STX signal, followed by the command, the parameters, and lastly an ETX signal in that order. Add parameters as required according to control details.

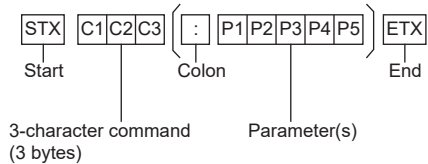

Command

| Command | Parameter | Control details |
|---------|-----------|---|
| PON | None | Power ON |
| POF | None | Power OFF |
| AVL | *** | Volume 000 – 100 |
| AMT | 0 | Audio MUTE OFF |
| | 1 | Audio MUTE ON |
| IMS | None | Input select (toggle) |
| | HM1 | HDMI 1 input (HDMI1) |
| | HM2 | HDMI 2 input (HDMI2) |
| | DP1 | DisplayPort IN input (DisplayPort) |
| | DL1 | DIGITAL LINK input (DIGITAL LINK) |
| | DV1 | DVI-D IN input (DVI-D) |
| | SL1 | SLOT input (SLOT) |
| | PC1 | PC IN input (PC) |
| | NW1 | Screen Transfer input (Screen Transfer) |
| | UD1 | USB input (USB) |
| DAM | None | Screen mode select (toggle) |
| | FULL | Full |
| | NORM | Normal |
| | NATV | Native |
| | HFIT | H fit |
| | VFIT | V fit |
| | ZOOM | Zoom1 |
| | ZOM2 | Zoom2 |
| | | |

Note

- If multiple commands are transmitted, be sure to wait for the response for the first command to come from this unit before sending the next command.
- If an incorrect command is sent by mistake, this unit will send an "ER401" command back to the computer.
- When sending a command which does not require parameter, a colon (:) is not needed.
- Consult your local Panasonic dealer for detail instructions on command usage.

For more details, visit the following web site.

<https://panasonic.net/cns/prodisplays/>

- For 98 and 86 inch models, [Screen Transfer] is displayed only when the main software version is 4.0000 or later.

IR IN / IR OUT terminal connection

Connect the stereo mini plug (M3) cable from the IR OUT terminal of the first display to the IR IN terminal of the second display.

The infrared signal of the first display is sent to the second display.

In this case, the IR (infrared ray reception on the remote control sensor) on the second display does not operate.

Repeating the above connections enables the daisy chain connection.

Note

- Connection cables are not supplied with this unit.
- Daisy chain connection is possible only between the displays of the same series.

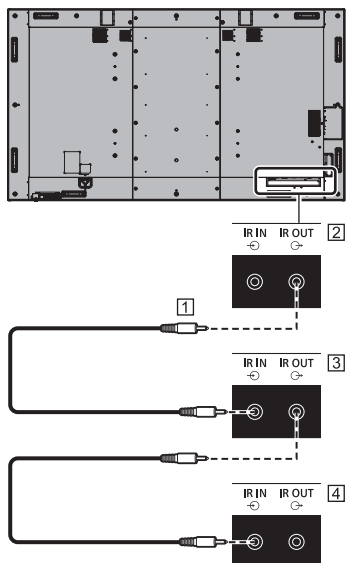

- 1 Stereo mini plug (M3) cable (commercially available)
- 2 First display
- 3 Second display
- 4 Third display

AUDIO OUT terminal connection

Note

- Audio equipment and the cable shown are not supplied with this set.

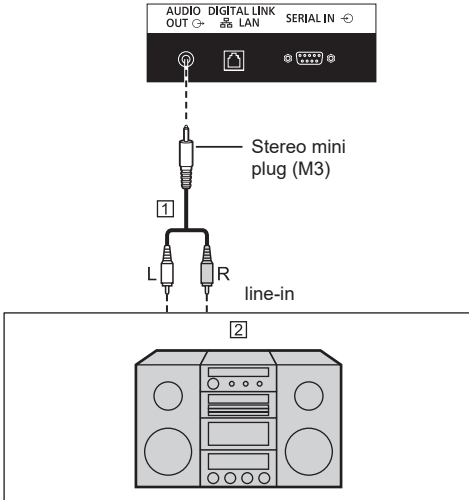

- ① Stereo audio cable (commercially available)
 ② Audio equipment

Note

- To output sound from AUDIO OUT terminal of the unit, be sure to set [Output select] in the [Sound] menu to [AUDIO OUT]. (see page 47)

USB terminal connection

Connect the USB memory (commercially available) to use "USB media player" or "Memory viewer". (see page 111, 123)

Also, power is supplied when a separately sold stick PC, etc. are connected.

Note

- A stick PC and connection cables are not supplied with this unit.
- If the power is turned off or the USB memory device is removed while accessing data in the USB memory device, the stored data may be destroyed. The access indicator of the USB memory device blinks during data access.
- The USB memory device can be connected or disconnected whether or not the display is on.

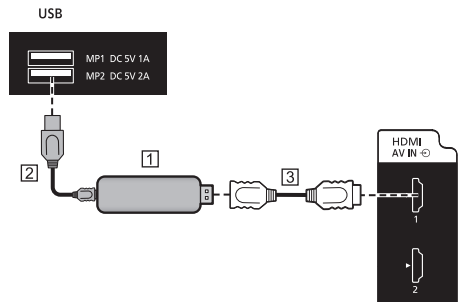

- ① Stick PC (commercially available)
 ② USB cable (commercially available)
 ③ HDMI extension cable (commercially available)

When the picture is displayed, depending on the USB terminal, power of up to 5V/2A (far side terminal) or 5V/1A (front side terminal) can be supplied to an external device.

- If the electric current exceeding the power supplying capability is applied, the output is blocked, and the following message is displayed.

[USB DC5V OUT overload. Please remove cable or equipment, then turn the display off/on.]

In this case, remove the equipment and then turn the power off/on using the remote control, etc.

Note

- Select the USB terminal to be used with [USB select]. (see page 90)
- If the direct connection to this unit is not possible due to the size of a stick PC, etc. use a commercially sold extension cable.
- Depending on the type of a USB memory device, it may come in contact with the periphery such as a back cover, and cannot be attached. Use a USB memory device connectable to this unit.
- When connecting the USB memory device, confirm the orientation of the plug to prevent damage to the terminal.

- When removing the USB memory device, note the following.
 - When the access indicator of the connected USB memory device is blinking, it shows the display is loading the data. Do not remove the USB memory device while blinking.
 - Depending on the USB memory device, the access indicator may remain blinking even when it is not being accessed, or the device is not equipped with an access indicator function, etc. In this case, remove the USB memory device after confirming the following ① or ②.
 - ① Switch the input to an input other than [USB] and [MEMORY VIEWER], and confirm that the functions that access USB memory device are finished. The functions are, read user image function (see page 73), playlist edit function (see page 118), data cloning function (see page 130), etc.
 - ② Turn the unit off.
- Do not frequently repeat connecting/disconnecting the USB memory device. Wait at least 5 seconds after connection, and then remove the USB memory device. Before reconnection, wait at least 5 seconds. A certain length of time is required so that the display can recognise that the USB memory device is switched for connection or disconnection.
- If the power of this unit is turned off or the USB memory device is removed accidentally while accessing data, the data may not be accessed next time the USB memory device is used.

In such a case, turn the power of the main unit off and on.
- When the power is supplied from MP2 (DC 5V 2A), use a cable supporting a current of 2A or more.

Speaker terminal connection

Use 8 Ω/15 W speaker.

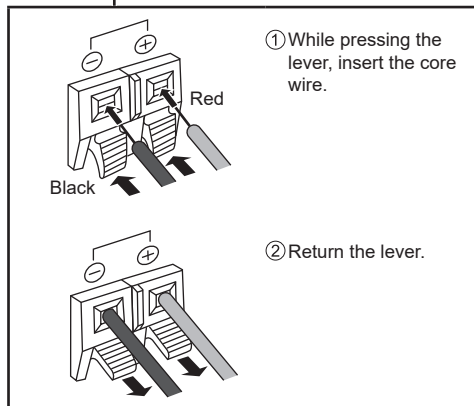
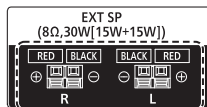

Identifying Controls

Display

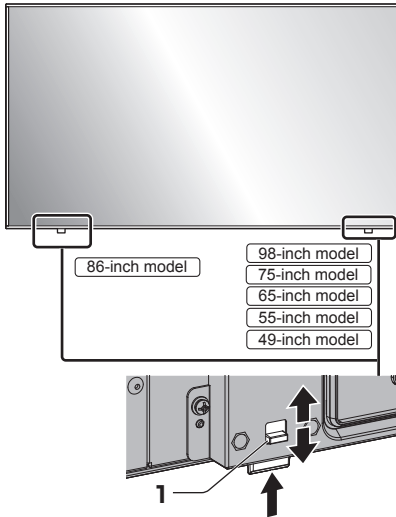

- Slide the lever on the rear panel to eject the power indicator and remote control sensor.
To store them, slide the same lever, or directly push in the bottom surface of the remote control sensor.

Note

- For normal use, pull out the power indicator and remote control sensor from the edge side of the main unit by operating the lever on the rear panel. Depending on the setup condition such as when using multi screen display of the multi display, store them in the main unit.

1 Power Indicator / Remote control sensor

The Power Indicator will light.

When the power of the unit is ON (Main Power On / Off button: ON)

- Picture is displayed: green
- When the unit enters the standby mode using the following functions: orange (red / green)
 - Standby state with the “Power management” function

About “Power management” function, see page 69.

- Standby state with [HDMI-CEC control] set to [Enable] and at least one [Link function] set to other than [Disable]

About [HDMI-CEC control] setting and [Link function], see page 72.

- Standby state with [Network control] set to [On]

About “Network control” settings, see page 77.

- Standby state during schedule play mode

About “Schedule play mode”, see page 120.

- Standby state in conditions other than the above: red

When the power of the unit is OFF (Main Power On / Off button: OFF): No light

Note

- Even if the unit is turned off with the power indicator off, some of the circuits are in power-on status.
- When the power indicator is orange, power consumption during standby is generally larger than that of when the power indicator is red.

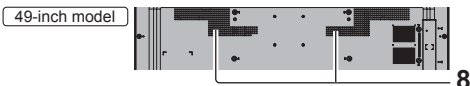
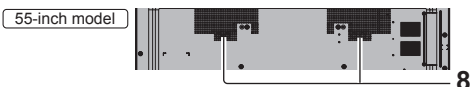
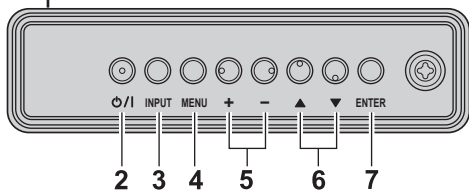
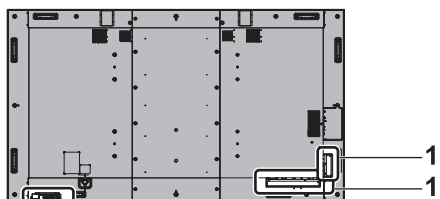

1 External input / output terminal

Connects to video equipment, PC, etc. (see page 21)

2 <Main Power On / Off button> (⏻/⏻)

Turns the power On / Off.

3 <INPUT (Unit)>

Selects the connected device. (see page 37)

4 <MENU (Unit)>

Displays the menu screen. (see page 43)

5 <+ (Unit)> / <- (Unit)>

Adjusts the volume. (see page 38)

On the main screen, switches settings or adjusts settings level. (see page 43)

6 <▲ (Unit)> / <▼ (Unit)>

Selects the setting item on menu screen. (see page 43)

7 <ENTER (Unit)>

Configures the item on menu screen. (see page 43)

Switches aspect mode. (see page 40)

8 Built-in speakers

Sound is output backward.

Note

- To output sound from the built-in speakers of the unit, be sure to set [Sound] - [Output select] to [INTERNAL SPEAKERS]. (see page 47)

Remote Control Transmitter

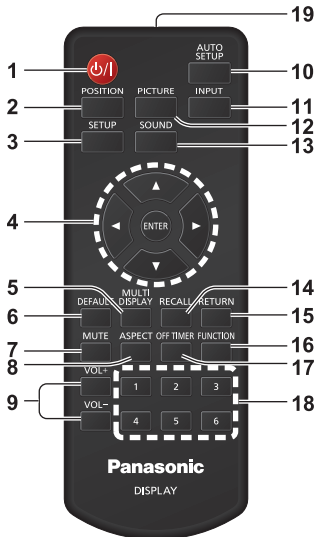

1 Standby (ON/OFF) button (⏻/⏻)

- Turns the power on or off when the unit is turned on at the <Main Power On / Off button>. (see page 36)

2 POSITION

(see page 45)

3 SETUP

(see page 55)

4 ENTER / Cursor buttons (▲▼◀▶)

- Used to operate the menu screens. (see page 43)

5 MULTI DISPLAY

- Switches between on and off of the multi display mode (multi input display, multi screen display). (see page 55)

6 DEFAULT

- Resets the settings of picture, sound, etc., to defaults. (see page 45, 47, 48)

7 MUTE

- Sound mute on / off. (see page 38)

8 ASPECT

- Adjusts the aspect. (see page 40)

9 VOL + / VOL -

- Adjusts sound volume level. (see page 38)

10 AUTO SETUP

- Automatically adjusts the position/size of the screen. (see page 45)

11 INPUT

- Switches input to display on the screen. (see page 37)

12 PICTURE

(see page 48)

13 SOUND

(see page 47)

14 RECALL

- Displays the current setting status of Input mode, Aspect mode, etc. (see page 38)

15 RETURN

- Used to return to the previous menu. (see page 43)

16 FUNCTION

- Displays [Function button guide]. (see page 85)

17 OFF TIMER

- Switches to stand-by after a fixed period. (see page 39)

18 Numeric buttons (1 - 6)

- Used as shortcut buttons by assigning frequently used operations. (see page 84)

19 Signal emission

Note

- In this manual, buttons of the remote control and the unit are indicated as < >.

(Example: <INPUT>.)

The operation is mainly explained indicating the remote control buttons but you can also operate with the buttons on the unit when there are the same buttons.

- In the case of the Model No. DPVF1615ZA remote control, the <MULTI DISPLAY> button for item 5 is replaced with the <ZOOM> button.

Basic Controls

Main Power On / Off button (⏻/⏻)

(Back of the unit)

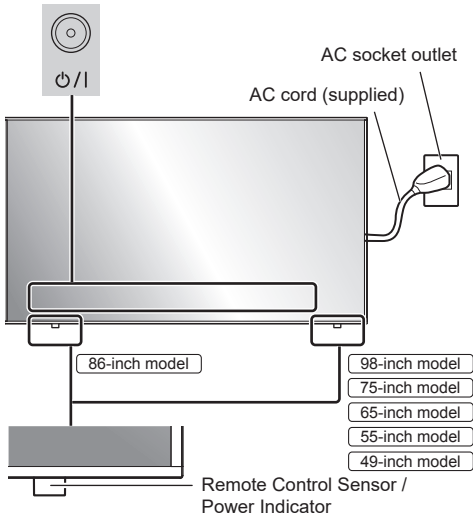

Operate pointing the remote control directly at the unit's Remote Control Sensor.

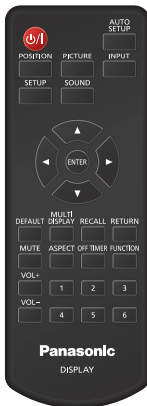

Note

- For normal use, pull out the remote control sensor from the edge side of the main unit by operating the lever on the rear panel. (see page 32)
- Do not put an obstacle between the remote control sensor of the main unit and the remote control.
- Operate the remote control in front of the remote control sensor or from the area where the sensor can be seen.

- When directly aiming the remote control at the remote control sensor of the main unit, the distance from the front of remote control sensor should be approx. 7 m or less. Depending on the angle, the operation distance may be shorter.
- Do not subject the remote control sensor of the main unit to the direct sunlight or strong fluorescent light.

1 Connect the AC cord plug to the Display.

(see page 19)

2 Connect the plug to the socket outlet.

Note

- Main plug types vary between countries. The power plug shown at left may, therefore, not be the type fitted to your set.
- When disconnecting the AC cord, be absolutely sure to disconnect the AC cord plug at the socket outlet first.
- The settings may not be saved if the power plug is disconnected immediately after changing settings with on-screen menu. Disconnect the power plug after a enough period of time. Or, disconnect the power plug after turning the power off with the remote control, RS-232C control or LAN control.

3 Press the <Main Power On / Off button> (⏻/⏻) on the unit to turn the power of the unit on.

- Power Indicator: Green (Picture is displayed.)
- When the power of the unit is on, the power indicator lights up and remote control operation is possible.
- When the power indicator is lit, it is not necessary to press the <Main Power On / Off button> (⏻/⏻) on the unit. Operate the remote control so that the power indicator turns green (picture is displayed).

■ To turn the power ON/OFF with the remote control

To turn the power on

- When the power of the unit is on (Power Indicator - red or orange), press the <Standby (ON/OFF) button> (⏻/⏻), then the picture will be displayed.
- Power Indicator: Green (Picture is displayed.)

To turn the power off

- When the power of the unit is on (Power Indicator - green), press the <Standby (ON/OFF) button> (⏻/⏻), then the power will be turned off.
- Power Indicator: Red (standby)

Note

- During operation of the "Power management" function (see page 69), the power indicator turns orange in the power off state.
- After the power plug is disconnected, the power indicator may remain lit for a while. This is not a malfunction.
- Press the <Main Power On / Off button> (⏻/⏻) on the unit to turn the unit off, when the power of the unit is turned on or in standby mode.

■ When the Unit is turned on for the first time

Following screen will be displayed.

1 Select the language with ▲ ▼ and press <ENTER>.



2 For vertical installation, select [Portrait] with ▲ ▼ and press <ENTER>.

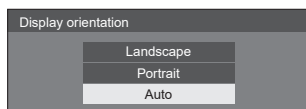

Note

- Once the items are set, the screens won't be displayed when switching on the unit next time. Each item can be reset in the following menus. [OSD language] (see page 74) [Display orientation] (see page 86)

■ Power ON message

The following message may be displayed when turning the unit power ON:

No activity power off Precautions

'No activity power off' is enabled.

When [No activity power off] in the [Setup] menu is set to [Enable], a warning message is displayed every time the power is turned ON. (see page 74)

"Power management" information

Last turn off due to 'Power management'.

When "Power management" is functioned, an information message is displayed every time the power is turned ON. (see page 69)

Display reverse installation information

The display is upside-down.

When it is judged that the display is reversely installed, an information message is displayed when the power is turned ON. (see page 63)

These message displays can be set with the following menu:

- [Power on settings] menu
 - Information(No activity power off) (see page 63)
 - Information(Power management) (see page 63)
 - Information(Display upside-down) (see page 63)

Selecting the input signal

Select the signals input to the unit.

Press <INPUT> or <INPUT (Unit)>.

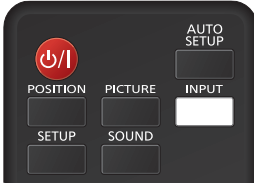

Unit

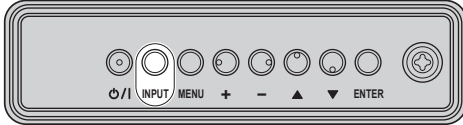

Switches input every time the buttons are pressed.

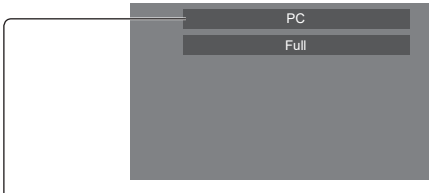

[HDMI1] → [HDMI2] → [DisplayPort] →
 [DIGITAL LINK] → [DVI-D] (or [SLOT]) → [PC] →
 [Screen Transfer] → [USB] → [MEMORY VIEWER]

[HDMI1]: HDMI 1 terminal, HDMI input

[HDMI2]: HDMI 2 terminal, HDMI input

[DisplayPort]: DisplayPort IN terminal, DisplayPort input

[DIGITAL LINK]: DIGITAL LINK terminal, DIGITAL LINK input

[DVI-D]*: DVI-D IN terminal, DVI-D input

[SLOT]*: Input signal of the function board

[PC]: PC IN terminal, PC input

[Screen Transfer]: Input that displays images transmitted via network using "Screen Transfer", a dedicated application by Panasonic

[USB]: USB terminal, USB input

[MEMORY VIEWER]: USB terminal, "Memory viewer" input

*: For [DVI-D] and [SLOT] input, either one selected for the [DVI-D/SLOT select] setting is displayed. (see page 90)

Note

- Displays the signal name as set in [Input label]. (see page 69)
- Input will not be switched unless [Input lock] is set to [Off]. (see page 74)

- Image retention may occur on the LCD liquid crystal panel when a still picture is kept on the panel for an extended period. To prevent such a problem, using the screensaver and the [Wobbling] function is recommended. (see page 67, 68)
- Switching to another input while the unit is connected to Screen Transfer with Screen Transfer input will break the connection. Check the connection again after switching the input.
- For 98 and 86 inch models, [Screen Transfer] is displayed only when the main software version is 4.0000 or later.

RECALL

It is possible to check the setting status of input label, picture mode, etc.

Press **<RECALL>**.

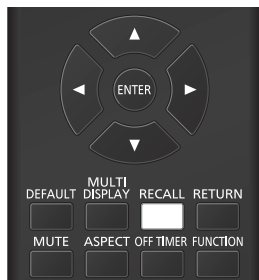

Current setting status will be displayed.

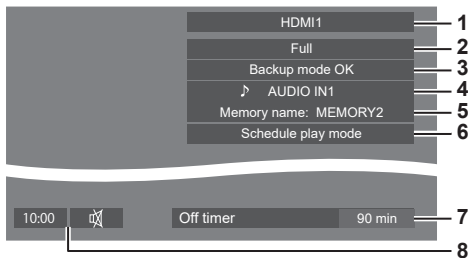

- 1 Input label
- 2 Aspect mode (see page 40)
- 3 Backup input change (see page 66, 67)
- 4 Audio input (see page 71)
- 5 Profile name (see page 53)
- 6 [Schedule play mode] (see page 120)
- 7 Off timer remaining time (see page 39)
- 8 Clock / Mute (see page 38, 76)

- When there is no video signal to the selected input, [No signal] is displayed for about 30 seconds at the end.
- When a USB memory is not connected to the USB terminal at the time of switching to the USB input, [No external media] is displayed for about 30 seconds. Even when a USB memory is connected, if it does not contain any playable file, [No play file] is displayed at all times.
- When [No signal image settings] - [Display setting] is set to [On] (see page 73), the message [No signal] / [No external media] / [No play file] are not displayed. Instead, the image set in [No signal image settings] will be displayed.
- To display the clock, set [Date and time] and then set [Clock display] to [On]. (see page 76)

Volume Adjustment

Press **<VOL +>** **<VOL ->** or **<+ (Unit)>** **<- (Unit)>** to adjust volume.

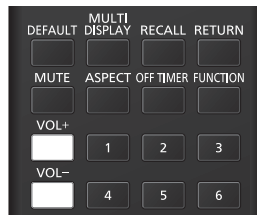

Unit

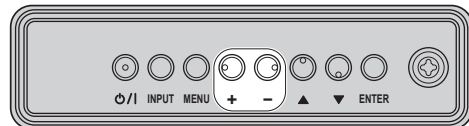

- The current sound volume level is memorised even if the power is turned off.
- When [Maximum VOL function] is set to [On], the volume can only be adjusted to the maximum point you set, and the displayed value turns red when it reached its maximum. (see page 89)
- When [Initial VOL function] is set to [On], the volume will be at the set level when the display is turned on. (see page 62)



Sound mute On / Off

It is useful when you want to mute the sound temporarily, for example, when answering the phone or door.

Press **<MUTE>**.

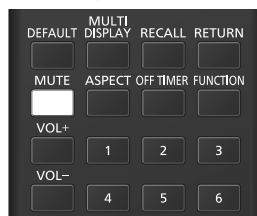
-  appears on the screen and the sound is muted. Press again to reactivate the sound.



- It is also reactivated when the power is turned on / off or the volume level is changed.
- While MUTE is active,  is displayed as a reminder after operation.
- When the image set in [No signal image settings] (see page 73) is displayed,  is not displayed after operation.
- In [ENGLISH(US)] OSD language,  is displayed as [MUTE].

OFF TIMER

The Display can be preset to switch to stand-by after a fixed period. (30 min, 60 min, 90 min)

The setting switches each time <OFF TIMER> is pressed.

- [0 min] → [30 min] → [60 min] → [90 min]
→ [0 min] (Cancel)

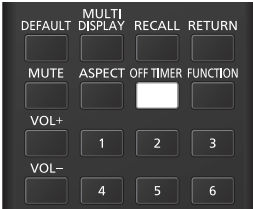

- When three minutes remain, the remaining time will flash (Red). After that, it switches to stand-by.
- To see the Off timer remaining time, press <RECALL>.
- The Off timer is cancelled if a power interruption occurs. When the power is turned on later on, it will be in stand-by condition.
- When the image set in [No signal image settings] (see page 73) is displayed, remaining time is not displayed even when the timer expires in 3 minutes. Instead, the image is displayed until the power is turned off. Press <RECALL> to check the remaining time.

ASPECT Controls

Press <ASPECT> or <ENTER (Unit)> repeatedly to move through the aspect options:

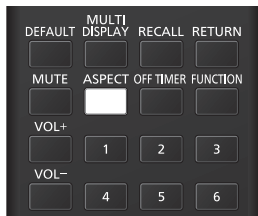

Unit

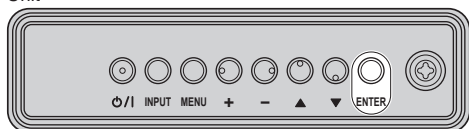

[Normal] → [Native] → [H fit] → [V fit] → [Zoom1] → [Zoom2] → [Full]

Note

- When using Screen Transfer input, the aspect mode cannot be changed.
- The aspect mode is memorised separately for each input terminal.
- Aspect modes [H fit] and [V fit]:

Even if the display is installed vertically, the enlargement directions for the [H fit] and [V fit] aspect modes are the same as those in horizontal installation.

The enlargement directions do not change in the following cases as well.

- When the unit is installed in the portrait setting by setting [Display orientation] to [Portrait] or [Auto]. (see page 86)
- When [USB media player settings] - [Still picture rotation] is set to [Portrait]. (see page 82)

■ List of Aspect Modes

| Aspect mode | Description |
|-------------|---|
| Full | <p>Picture → Enlarged screen</p> <p>Pictures are displayed filling the screen.</p> |
| | <p>Pictures are displayed with the aspect ratio of input signals.</p> |
| Normal | <p>Pictures are displayed with the aspect ratio of input signals.</p> |
| Native | <p>Pictures are displayed with the resolution of input signals.</p> |
| H fit | <p>Pictures are enlarged to the maximum horizontal dimension of the screen.</p> |
| | <p>Pictures of signals with the aspect ratio vertically longer than the aspect ratio of the screen are displayed with the top and bottom of the pictures cut.</p> |
| V fit | <p>Pictures are enlarged to the maximum vertical dimension of the screen.</p> |
| | <p>Pictures of signals with the aspect ratio horizontally longer than the aspect ratio of the screen are displayed with the right and left of the pictures cut.</p> |
| Zoom1 | <p>Letterbox pictures with a 16:9 aspect ratio are enlarged vertically to fill the screen. The top and bottom edges of the pictures are cut off.</p> |
| Zoom2 | <p>Letterbox pictures with a 16:9 aspect ratio are enlarged vertically and horizontally to fill the screen. The top and bottom edges as well as the left and right edges of the pictures are cut off.</p> |

Note

- This display incorporates several types of aspect mode select functions. If a mode whose aspect ratio is different from that of TV program content is selected, the on-screen appearance will differ from that of the original images. Note this point when selecting an aspect mode.
- Be aware that if you put the display in a public place for commercial purposes or a public showing and then use the aspect mode select function to shrink or expand the picture, you may be violating the copyright under copyright law. It is prohibited to show or alter the copyrighted materials of other people for commercial purposes without the prior permission of the copyright holder.
- When viewing a non-wide picture with a 4:3 aspect ratio by displaying in full screen using a zoom mode or the 16:9 mode, the circumference image will be partially invisible or deformed. Original images can be viewed in the [Normal] mode with respect for creators' intentions.

Digital ZOOM

Select the screen areas (25 areas) to zoom in, and zoom in the selected image areas $\times 2$, $\times 3$ or $\times 4$.

(Assign [Digital zoom] to a numeric button in [Setup] - [Function button settings], and then operate.)

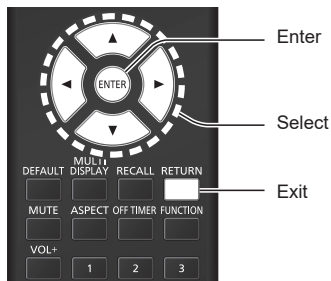

1 Set the digital zoom mode.

When [Digital zoom] is assigned to a numeric button in [Function button settings], and then operated by the button, the digital zoom mode is set. (see page 84)

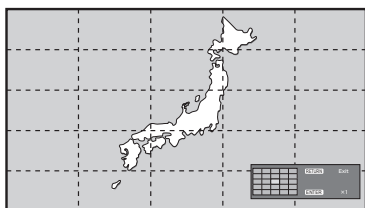

The screen aspect is set to [Full], and the digital zoom operation guide is displayed.

2 Select the image areas to zoom in.

Select pressing $\blacktriangledown \blacktriangleleft \blacktriangleright$.

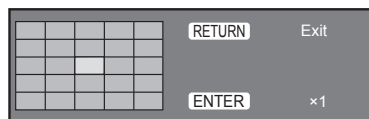

Digital Zoom operation guide

3 Switch the zoom ratio for the screen areas.

Switches every time <ENTER> is pressed.

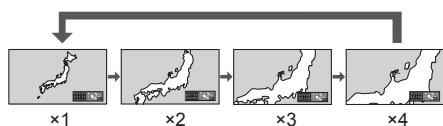

- If no operation is performed for the period set for [Menu display duration] (see page 86) (5 – 180 seconds) **when the zoom ratio for the screen is “ $\times 1$ ”**, the unit exits the zoom mode.
- If no operation is performed for approx. 3 seconds **when the zoom ratio for the screen is “ $\times 2$ ”, “ $\times 3$ ” or “ $\times 4$ ”**, the digital zoom operation guide display disappears. Pressing any of the $\blacktriangledown \blacktriangleleft \blacktriangleright$ buttons displays the guide again.

4 Exit the digital zoom mode.

Press <RETURN> to exit the mode.

The screen returns to the previous state just before entering the digital zoom mode, and the digital zoom operation guide display disappears.

- Press any of the following buttons to exit the mode. Then, the operation of the pressed button is performed.

Remote Control:

<AUTO SETUP> <POSITION> <PICTURE>
<INPUT> <SETUP> <SOUND>
<DEFAULT> <MULTI DISPLAY> <RECALL>
<MUTE> <ASPECT> <OFF TIMER>
<FUNCTION> <VOL +> <VOL -> <1> – <6>

Unit:

<INPUT (Unit)> <MENU (Unit)> <+ (Unit)>
<- (Unit)> $\blacktriangle \blacktriangledown$ <ENTER (Unit)>

- When the screen saver timer starts up, the digital zoom mode finishes.
- When the power is turned OFF, a force-quit is performed.
 - When the power is turned OFF by pressing the <Standby (ON/OFF) button>.
 - When the display is turned OFF at the <Main Power On / Off button>
 - When the power is turned OFF by the off-timer
 - When the power is turned OFF by [No signal power off] or “Power management”.

Note

- Use the remote control for operation. Some of the operations cannot be performed with the buttons on the main unit.
- In the following cases, the digital zoom mode is not available.
 - When [Multi display settings] - [Multi screen display] is set to [On]
 - When [Portrait settings] - [Portrait display] is set to [On]
 - When the screen saver is in operation
 - When Screen Transfer / USB / MEMORY VIEWER input is selected.
- The zoomed image is rougher than the original image.
- When using the remote control with model number DPVF1615ZA, the <ZOOM> button can be used for operation.

On-Screen Menu Displays

1 Display the menu screen.

Remote Control

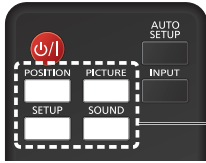

Press to select.

Unit

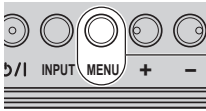

Press for several times.

Each time the button is pressed, the menu screen will switch.

Normal Viewing → [Picture] → [Setup] → [Position] → [Sound]

2 Select the item.



Press to select.

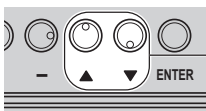

Press to select.

(Example: [Picture] menu)

| Picture | |
|--------------------|----------|
| Default | Default |
| Picture mode | Standard |
| Backlight | 50 |
| Contrast | 50 |
| Brightness | 50 |
| Colour | 50 |
| Hue | 50 |
| Sharpness | 50 |
| Enhance level | High |
| Gamma | 2.2 |
| Colour temperature | 6500K |
| Colour management | Off |
| Dynamic contrast | 5 |
| Colour enhancement | Off |
| Refine enhancer | Off |
| Gradation smoother | Off |
| Memory save | |
| Memory load | |
| Memory edit | |

To display the submenu, press <ENTER>.

3 Set.

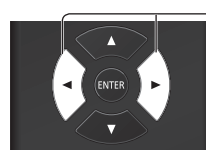

Press to set.

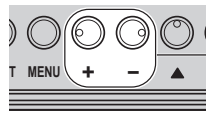

Press to set.

4 Exit from the menu.

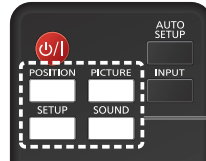

Press.

Press <RETURN> to return to the previous screen.

Alternatively, press the button selected in step 1 to exit from the menu.

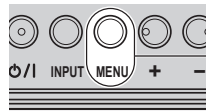

Press for several times.

Note

- When changing the settings of the display, picture or sound disturbance may occur temporarily. This is not a malfunction.

Menu display list

- Menu that cannot be adjusted is greyed out.
Adjustable menu changes depending on signal, input and menu setting.

[Position] menu

(see page 45 – 46)

| Position | |
|-----------------|---------|
| Default | Default |
| Auto setup | |
| H-position | 0 |
| H-size | 0 |
| V-position | 0 |
| V-size | 0 |
| Clock phase | 15 |
| Dot clock | 0 |
| Over scan | Off |
| PC auto setting | |
| | Off |

[Sound] menu

(see page 47)

| Sound | |
|---------------|-------------------|
| Default | Default |
| Output select | INTERNAL SPEAKERS |
| Balance | 0 |
| Sound mode | Normal |
| Bass | 0 |
| Treble | 0 |
| Surround | Off |
| Auto volume | |
| Installation | Stand |

[Picture] menu

(see page 48 – 54)

| Picture | |
|--------------------|----------|
| Default | Default |
| Picture mode | Standard |
| Backlight | 50 |
| Contrast | 50 |
| Brightness | 50 |
| Colour | 50 |
| Hue | 50 |
| Sharpness | 50 |
| Enhance level | High |
| Gamma | 2.2 |
| Colour temperature | 6500K |
| Colour management | Off |
| Dynamic contrast | 5 |
| Colour enhancement | Off |
| Refine enhancer | Off |
| Gradation smoother | Off |
| Memory save | |
| Memory load | |
| Memory edit | |

[Setup] menu

(see page 55 – 90)

| Setup | | 1/3 |
|---------------------------|--|-------------|
| Multi display settings | | |
| Portrait settings | | |
| Signal | | |
| Power on settings | | |
| Input search | | |
| Failover/Failback | | |
| Screensaver | | |
| Input label | | |
| Power management settings | | |
| Audio input select | | |
| HDMI-CEC settings | | |
| Image settings | | |
| Input lock | | Off |
| Off-timer function | | Enable |
| No activity power off | | Disable |
| OSD language | | English(UK) |

| Setup | | 2/3 |
|---------------------------|--|-----------|
| Set up timer | | |
| Date and time | | |
| Network settings | | |
| USB media player settings | | |
| Memory viewer settings | | |
| Function button settings | | |
| OSD settings | | |
| Display orientation | | Landscape |
| Image rotation | | Off |

| Setup | | 3/3 |
|-------------------------|---|-------|
| Options | | |
| Control settings | | |
| Information timing | | |
| SLOT settings | | |
| Maximum VOL function | | Off |
| Maximum VOL level | 0 | |
| Button lock | | Off |
| POWER button lock | | Off |
| Controller user level | | Off |
| DVI-D/SLOT select | | DVI-D |
| USB select | | MP1 |
| Quick input change mode | | Off |

Note

- When [DVI-D/SLOT select] is set to [SLOT], [DVI-D] input is displayed as [SLOT]. (see page 90)

Adjusting Position

1 Press <POSITION> to display the [Position] menu.

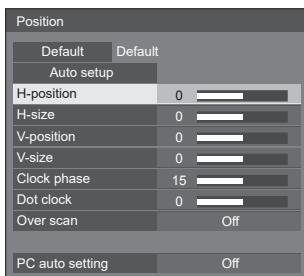

2 Select the item to adjust with ▲ ▼.

- Unadjustable items are greyed out.
Adjustable items differ depending on the signal, input and the display mode.

3 Adjust with ◀ ▶.

4 Press <POSITION> to exit from adjust mode.

■ To return to the previous screen

Press <RETURN>.

■ To reset to defaults

When [Default] is selected, pressing <ENTER> resets the adjustment values of all the displayed menus to default.

When adjusting each item, pressing <DEFAULT> resets the adjustment value of the item to default.

Note

- When using Screen Transfer input, [Position] cannot be set.
- Settings for [Position] are memorised separately for each input signal.

Setting [Position] when [Image rotation] is set to [180 degrees]

When [Image rotation] is set to [180 degrees], the adjustment direction becomes opposite of that in [Off] state. (see page 87)

Note these points for adjustment.

Auto setup

When inputting a PC signal, [H-position] / [V-position], [H-size] / [V-size], [Clock phase] and [Dot clock] are automatically corrected.

This setting is enabled under the following condition:

- This setting is enabled when an analogue signal (PC) is input and the aspect mode is set to [Full]. (see page 90)

While displaying the picture of the corresponding signal, select [Auto setup] and press <ENTER>.

Using Remote Control

Press <AUTO SETUP>.

When Auto Setup does not work, [Invalid] is displayed.

Note

- When the dot clock frequency of a PC signal is 162 MHz or higher, [Clock phase] and [Dot clock] cannot be automatically corrected.
- Auto Setup may not work when a cropped or dark image is input. In such case, switch to a bright image with borders and other objects are clearly shown, and then try auto setup again.
- Depending on the signal, out of alignment may occur after Auto Setup. Carry out fine tuning for the position/size as required.
- If the automatic position adjustment is not optimized depending on the signal, switching the [Input resolution] (see page 61) setting may be able to perform the automatic position adjustment properly.
- Accurate auto setup is not possible when a signal such as additional information is superimposed out of valid image period or when intervals between synchronizing signal and image signal are short. Also, accurate auto setup is not possible when image signals with tri level synchronizing signal added are input.
- When [PC auto setting] is set to [On], automatic position adjustment starts under the following conditions:
 - When the display power is turned ON.
 - When the input signal is switched.
- If Auto Setup does not work well, select [Default], press <ENTER>, and then adjust the position/size manually.

[H-position] Adjust the horizontal position with ◀▶.

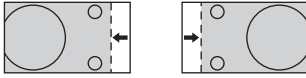

[H-size] Adjust the horizontal size with ◀▶.

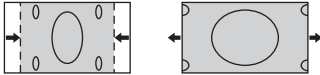

[V-position] Adjust the vertical position with ◀▶.

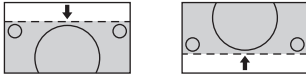

[V-size] Adjust the vertical size with ◀▶.

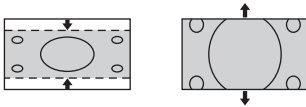

[Clock phase] (For PC IN input)

In some cases, frame of the screen appears blurred or smudged, when PC signal is input.

[Dot clock] (For PC IN input)

Periodic striped pattern interference (noise) may occur when a striped pattern is displayed. If this happens, adjust so that any such noise is minimized.

[Over scan] Turn image over scan On/Off.

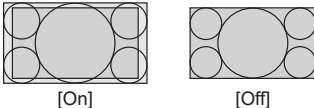

Note

- This is enabled when the screen mode is set to [Full], [Zoom1] or [Zoom2].
Note this setting is disabled when using USB / MEMORY VIEWER input, multi screen display of the multi display or digital zoom.

[PC auto setting] Sets the operational mode of the automatic position adjustment in the [Position] menu.

[Off]:

Automatic position adjustment starts when <AUTO SETUP> is pressed on the remote control or automatic position adjustment is executed from the [Position] menu.

[On]:

Other than remote control or menu operation, automatic position adjustment starts:

- When the display power is turned ON.
- When the input signal is switched.

Note

- In some cases, noise appears outside the area picture is displayed, but it is not a malfunction.

Sound Adjustment

1 Press <SOUND> to display the [Sound] menu.

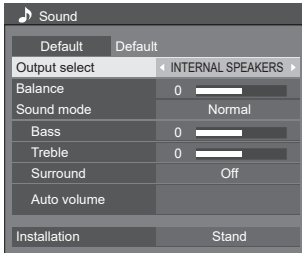

2 Select the item to adjust with ▲ ▼.

- Menu that cannot be adjusted is greyed out.

3 Adjust with ◀ ▶.

4 Press <SOUND> to exit from adjust mode.

■ To return to the previous screen

Press <RETURN>.

■ To reset to defaults

Press <DEFAULT> while the menu is displayed, or press <ENTER> when [Default] is selected, then the adjustment values of all the displayed menus are reset to default.

[Output select] Select the audio output.

[INTERNAL SPEAKERS]:

Internal speakers output

[EXTERNAL SPEAKERS]:

External speakers (EXT SP terminal) output

[AUDIO OUT]:

AUDIO OUT terminal output

- When [AUDIO OUT] is selected, the other menus are greyed out and cannot be selected.
- Audio volume setting is memorized separately for each output.

[Balance] Adjusts left and right volumes.

[Sound mode] Select for best audio.

[Normal]:

Emits the original sound.

[Dynamic]:

Accentuates sharp sound.

[Clear]:

Attenuates human voice.

- In [ENGLISH(US)] OSD language, [Sound mode] and [Normal] are displayed as [AUDIO MENU] and [STANDARD].

[Bass]

Adjusts low pitch sounds.

[Treble]

Adjusts high pitch sounds.

[Surround]

[Off]:

Normal sound

[On]:

Surround sound

Note

- [Bass], [Treble] and [Surround] settings are memorised separately for [Normal], [Dynamic] and [Clear] in [Sound mode].

[Auto volume]

Adjusts the volume level automatically. Select from among [Min], [Mid] and [Max] according to the degree of imbalance of sound level.

[Off], [Min], [Mid], [Max]
(Small effect - Large effect)

Note

- This menu is available when [Clear] is selected in [Sound mode].
- When [Auto volume] is activated ([Max] / [Mid] / [Min]), [Surround] will be [Off].
- Use this function when the sound level is variable during TV conference, etc.
- When listening to music, the sound volume may become off-balance between vocals and instruments, which may create a feeling of strangeness or make it difficult to hear audio due to emphasized noise. In this case, lower the adjustment level (e.g., [Max] → [Min]), or set the function to [Off].
- For 98/86 inch models, this menu is displayed only when the main software version is 4.0000 or later.

[Installation]

Switch the audio to audio suitable to the installation environment.

[Stand]:

Audio suitable to pedestal installation

[Wall mounted]:

Audio with slightly reduced sound reflection suitable to wall-hanging installation

Note

- This menu is available when [INTERNAL SPEAKERS] is selected in [Output select].
- For 98/86 inch models, this menu is displayed only when the main software version is 4.0000 or later.

Picture Adjustments

1 Press <PICTURE> to display the [Picture] menu.

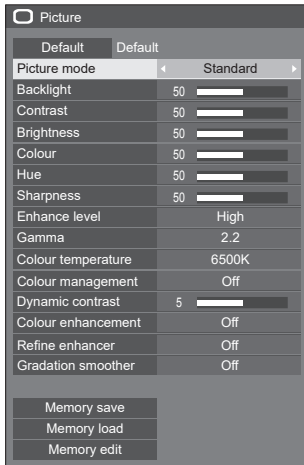

2 Select the item to adjust with ▲ ▼.

- Menu that cannot be adjusted is greyed out.

3 Adjust with ◀ ▶.

4 Press <PICTURE> to exit from adjust mode.

■ To return to the previous screen

Press <RETURN>.

■ To reset to defaults

When [Default] is selected, pressing <ENTER> resets the adjustment values of all the displayed menus to default.

When adjusting each item, pressing <DEFAULT> resets the adjustment value of the item to default.

Note

- When displaying still pictures with the USB input (USB media player) or displaying the thumbnail screen or file list screen of the MEMORY VIEWER input (Memory viewer) (see page 124), only the following settings have an effect on the picture. [Backlight], [Gamma], [Colour temperature]

[Picture mode]

This menu switches to easy-to-see pictures suitable to the picture source or environment where this unit is used.

[Vivid signage]:

Suitable for signage applications featuring more vivid and sharper images in bright environments such as a shop.

[Natural signage]:

Suitable for signage applications such as merchandise exhibition, featuring natural tone images with colour reproduction emphasized under light.

[Standard]:

Faithfully reproduces original picture.

[Surveillance]:

Tone-focused pictures with brightness reduced suitable for input from a monitoring camera.

[Graphic]:

Suitable for PC input.

[DICOM]:

Pictures close to the grayscale standard DICOM Part14.

- The settings are memorised separately for each input terminal.

Note

- DICOM is the abbreviation for “Digital Imaging and Communications in Medicine”, which is a standard for communications between medical imaging devices. Although “DICOM” is used as a picture mode name, this unit is not a medical device. Do not use displayed images for such purposes as diagnosis.
- In [ENGLISH(US)] OSD language, [Picture mode] is displayed as [PICTURE MENU].

[Backlight]

Adjusts luminance of the back light.

Darker ↔ Brighter

[Contrast]

Selects the proper brightness and density for the room.

Less ↔ More

- In [ENGLISH(US)] OSD language, [Contrast] is displayed as [PICTURE].

[Brightness]

Adjusts for easier viewing of dark pictures.

Darker ↔ Brighter

[Colour]

Adjusts colour saturation.

Less ↔ More

[Hue]

Adjusts hue of skin colour.

Reddish ↔ Greenish

- In [ENGLISH(US)] OSD language, [Hue] is displayed as [TINT].

[Sharpness] Adjusts picture sharpness.

Less ↔ More

[Enhance level] Switches the effect range for sharpness.

[High]: Large effect

[Low]: Small effect

[Gamma] Adjusts gamma.

[2.0], [2.2], [2.4], [2.6], [DICOM]:

Small tilt - Large tilt

Note

- When [DICOM] is selected in [Picture mode], [Gamma] is fixed to [DICOM].

When the items other than [DICOM] are selected in [Picture mode], [DICOM] cannot be set for [Gamma].

[Colour temperature] Adjusts colour tone.

[3200K], [4000K], [5000K], [6500K], [7500K], [9300K], [10700K], [Native], [User1], [User2]

Note

- Emphasizes red when the numerical value of [Colour temperature] is small, and emphasizes blue when it is big.
- [Native] is a colour tone of the panel element. When this is selected, [Gamma] is fixed to 2.2 or equivalent and it cannot be adjusted.
- When [DICOM] is selected in [Picture mode], only [6500K] and [9300K] can be selected.

User setting of [Colour temperature]

2 kinds of detailed [Colour temperature] settings ([User1] and [User2]) can be stored.

- 1 Press <ENTER> while setting [Colour temperature].

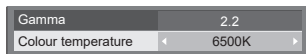

Example:

When [Colour temperature] is [6500K], it is possible to reflect the set point, [6500K], to the set point of [User1] and [User2].

- 2 Select the user to memorise settings with ▲ ▼ and press <ENTER>.

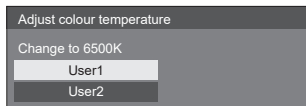

- 3 Select [Yes] with ◀▶ and press <ENTER>.



- 4 Set each item on detail settings screen.

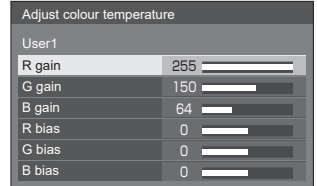

[R gain]

Adjusts the white balance for light red areas.

0 to 255

[G gain]

Adjusts the white balance for light green areas.

0 to 255

[B gain]

Adjusts the white balance for light blue areas.

0 to 255

[R bias]

Adjusts the white balance for dark red areas.

-127 to 128

[G bias]

Adjusts the white balance for dark green areas.

-127 to 128

[B bias]

Adjusts the white balance for dark blue areas.

-127 to 128

The settings are saved for the user. When you return to [Picture] menu, the user you have set is selected for [Colour temperature].

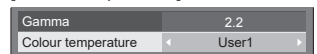

[Colour management]

Adjusts the colour tone of R (red), G (green), B (blue), complementary colours (cyan, magenta and yellow) and the intermediate colours on the screen individually.

[Off]: Disables colour management function.

[6-segment]: Enables 6-segment colour management function.

[12-segment]: Enables 12-segment colour management function.

1 Set [Colour management] to [6-segment] or [12-segment], and then press <ENTER>.

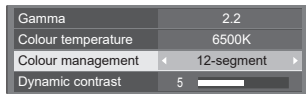

2 Set each item on detail settings screen.

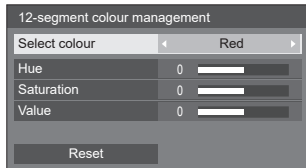

[Select colour]

Select the colour to adjust with ◀▶.

[Hue]

Adjusts colour balance.

- 127 to + 127

[Saturation]

Adjusts gradations of colour.

- 127 to + 127

[Value]

Adjusts brightness of colour.

- 127 to + 127

[Reset]

Resets to defaults. Select [Yes] with ▶◀ and press <ENTER>.

- In [ENGLISH(US)] OSD language, [Hue] is displayed as [TINT].

Note

- When [6-segment] is selected, R (red), G (green), B (blue) and complementary colours (cyan, magenta and yellow) are adjusted respectively. When [12-segment] is selected, [6-segment] items and the intermediate colours can be adjusted.

[Dynamic contrast]

Automatically adjusts the contrast by determining the changes in the use of colours for images that constantly change, such as motion pictures.

No effect ↔ Large effect

[Colour enhancement]

Displays images by emphasising colours.

[Off], [Low], [Mid], [High]
(Small effect to Large effect)

[Refine enhancer]

Enhances the sense of resolution by correcting fuzzy outlines of pictures resulted from resizing, etc.

[Off], [Low], [Mid], [High]
(Small effect to Large effect)

[Gradation smoother]

Extracts and eliminates noise components from the input video signals, and then displays noiseless pictures.

[Off], [On]

Picture Profiles

Up to 6 combinations of picture adjustment values (in the [Picture] menu) can be stored in the display memory as profiles and applied as needed, for a convenient way to enjoy your preferred picture settings.

Picture

| Default | Default | Standard |
|--------------------|---------|----------|
| Picture mode | | Standard |
| Backlight | 50 | |
| Contrast | 50 | |
| Brightness | 50 | |
| Colour | 50 | |
| Hue | 50 | |
| Sharpness | 50 | |
| Enhance level | | High |
| Gamma | | 2.2 |
| Colour temperature | | 6500K |
| Colour management | | Off |
| Dynamic contrast | 5 | |
| Colour enhancement | | Off |
| Refine enhancer | | Off |
| Gradation smoother | | Off |

Memory save

Memory load

Memory edit

[Memory save]

(see page 52)

[Memory load]

(see page 53)

[Memory edit]

(see page 53)

| | |
|--------|---------|
| 1. [] | MEMORY1 |
| 2. [*] | MEMORY2 |
| 3. [*] | MEMORY3 |
| 4. [] | MEMORY4 |
| 5. [] | MEMORY5 |
| 6. [] | MEMORY6 |

Overview of Picture Profiles

Original picture



Adjust picture.
(see page 48 – 50)



Custom picture



Example:
Save the picture adjustment values in the [MEMORY 1] profile.
[Memory save]

Original picture



Example:
Load [MEMORY1].
[Memory load]



Custom picture



[Memory edit] screen

| | |
|--------|---------|
| 1. [*] | MEMORY1 |
| 2. [*] | MEMORY2 |
| 3. [*] | MEMORY3 |

Example:
Change the memory name to [MY PICTURE].
[Memory edit]



| | |
|--------|------------|
| 1. [*] | MY PICTURE |
| 2. [*] | MEMORY2 |
| 3. [*] | MEMORY3 |

Saving profiles

Follow these steps to save picture adjustment values as profiles.

1 Specify the picture quality in the [Picture] menu.

(see page 48 – 50)

2 In the [Picture] menu, select [Memory save] with ▲▼ and press <ENTER>.

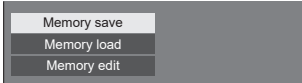

3 Select a profile name for saving the picture adjustment values with ▲▼ and press <ENTER>.

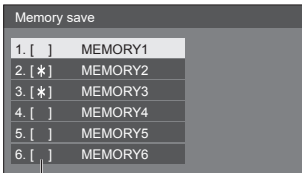

- [*] appears for a profile in which the picture adjustments have already been saved.

4 Select [Ok] with ◀▶ and press <ENTER>.

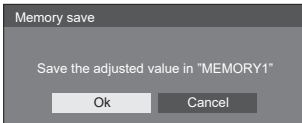

5 Enter a profile name with ▲▼◀▶.

- Entering characters (see page 137)



6 When you finished entering the profile name, select [Ok] with ▲▼◀▶ and press <ENTER>.



- To cancel saving the profile, select [Cancel].

Loading profiles

Load profiles and apply the picture adjustment values to the display as follows.

- 1 In the [Picture] menu, select [Memory load] with ▲ ▼ and press <ENTER>.

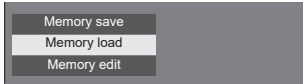

- 2 Select the profile to load with ▲ ▼ and press <ENTER>.

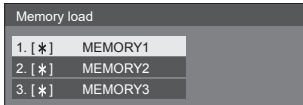

Loading profiles using numeric buttons on the remote control.

Each numeric button <1> – <6> is allocated for loading [MEMORY1] to [MEMORY6].

[Function button settings] (see page 84)

- 1 Press any of <1> – <6>.

- 2 Select [Ok] with ◀▶ and press <ENTER>.

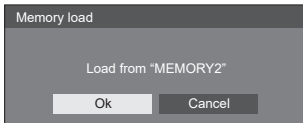

When profile is being loaded, profile name is displayed.

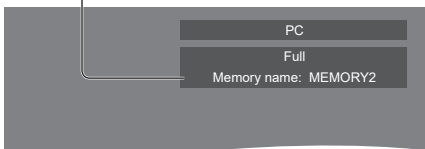

Note

- Loaded profiles are stored in memory according to the selected input terminal.

Editing profiles

Delete or rename profiles as follows.

Deleting profiles

- 1 In the [Picture] menu, select [Memory edit] with ▲ ▼ and press <ENTER>.

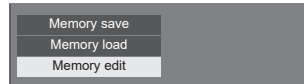

- 2 Select [Memory delete] with ▲ ▼ and press <ENTER>.

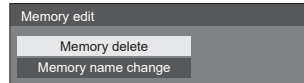

- 3 Select the profile to delete with ▲ ▼ and press <ENTER>.

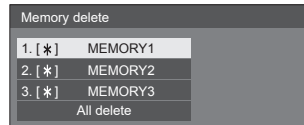

- To delete all profiles, select [All delete].

- 4 Select [Ok] with ◀▶ and press <ENTER>.

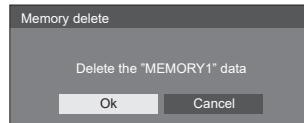

Renaming profiles

- 1 In the [Picture] menu, select [Memory edit] with ▲ ▼ and press <ENTER>.

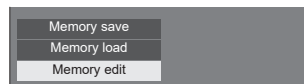

- 2 Select [Memory name change] with ▲ ▼ and press <ENTER>.

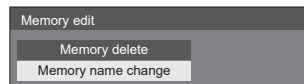

- 3 Select the profile to rename with ▲ ▼ and press <ENTER>.

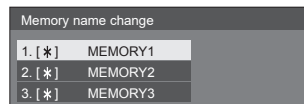

4 Enter a name for the profile with ▲ ▼ ◀ ▶.

- Entering characters (see page 137)

| | | | | | | | | | |
|---------|------------|-------|--------|----|---|---|---|---|---|
| MEMORY1 | | | | | | | | | |
| 1 | 2 | 3 | 4 | 5 | 6 | 7 | 8 | 9 | 0 |
| a | b | c | d | e | f | g | h | i | j |
| k | l | m | n | o | p | q | r | s | t |
| u | v | w | x | y | z | . | - | _ | |
| Delete | All delete | a/A/@ | Cancel | Ok | | | | | |

5 When you finished entering the profile name, select [Ok] with ▲ ▼ ◀ ▶ and press <ENTER>.

| | | | | |
|--------|------------|-------|--------|----|
| Delete | All delete | a/A/@ | Cancel | Ok |
|--------|------------|-------|--------|----|

- To cancel renaming the profile, select [Cancel].

Setup menu

1 Press <SETUP> to display the [Setup] menu.

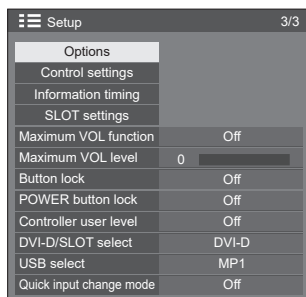
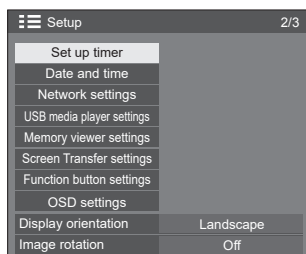
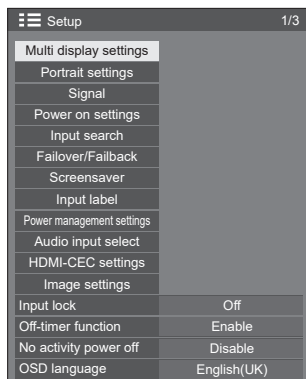

2 Select the item to set with ▲ ▼.

- Menu that cannot be adjusted is greyed out. Adjustable menu changes depending on signal input and menu setting.

3 Set with ◀ ▶.

4 Press <SETUP> to exit from adjust mode.

■ To return to the previous screen

Press <RETURN>.

Multi display settings

Set the screen display mode.

Note

- Set the input to something other than [Screen Transfer] / [MEMORY VIEWER], and then set [Multi display settings].
- While this menu is displayed, aspect mode will be [16:9].

1. [Multi display settings]

■ [Multi screen display]

[Off]:

The display is not divided when enlarged.

[On]:

The display is divided when enlarged.

When [On] is set, the display aspect is [Full].

Note

- When [Portrait display] is [On], this menu will be greyed out and cannot be set. (see page 58)

■ [Multi input display]

[Off]:

Disables the multi input display.

[On]:

Enables the multi input display.

Note

- This menu will be greyed out and cannot be set under the following condition.
 - When [USB media player settings] - [Schedule play function] is set to [Enable]. (see page 81)

■ [Screen type]

Displays the detailed settings for [Multi display settings].

Set the display format in each item.

[Multi input display]:

Displays the detailed settings to display images input from multiple terminals on the screen simultaneously.

For remote control operation for the multi input display, refer to "Using multi input display function of the multi display" (see page 129).

[Multi screen display]:

Displays the detailed settings to display the image enlarged as one group with multiple displays aligned in horizontal direction and vertical direction respectively.

2. [Screen type]: [Multi input display]

The screen is divided into several screens, and images input from multiple terminals are displayed simultaneously.

[Multi display settings] - submenu screen

([Multi input display]: [4 input display])

| Multi display settings | |
|------------------------|---------------------|
| Multi screen display | Off |
| Multi input display | Off |
| Screen type | Multi input display |
| Display format | 4 input display |
| Input (Upper/Left) | HDMI1 |
| Input (Upper/Right) | HDMI2 |
| Input (Lower/Left) | DVI-D |
| Input (Lower/Right) | PC |
| Sound output | Off |

Note

- Displayed contents on the screen differ depending on the [Display format] setting.

■ [Display format]

Set the display mode of the multi input display.

[4 input display]:

The screen is divided into four screens, and four input images are displayed simultaneously.

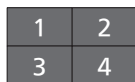

[Picture in picture]:

With two-screen configuration of the main screen and sub screen, two input images are displayed simultaneously.

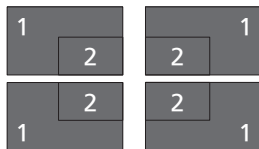

[Picture by picture]:

With two-screen configuration of top and bottom screens or right and left screens, two input images are displayed simultaneously.



In the portrait setting, the screen configurations are shown below.

[4 input display]:



[Picture in picture]:

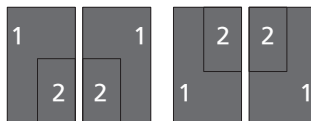

[Picture by picture]:

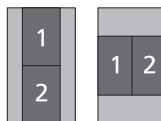

2-1 [4 input display] detailed settings

■ [Input (Upper/Left)] to [Input (Lower/Right)]

Set the input to display on the screen.

[HDMI1] / [HDMI2] / [DisplayPort] / [DVI-D] / [SLOT] / [PC]

■ [Sound output]

Set the terminal to output audio.

[Off] / [Upper/Left] / [Upper/Right] / [Lower/Left] / [Lower/Right] / [AUDIO IN1] / [AUDIO IN2]

2-2 [Picture in picture] detailed settings

■ [Sub picture location]

Set the position of the sub screen.

[Upper/Left] / [Upper/Right] / [Lower/Left] / [Lower/Right]

■ [Input(Main)] to [Input(Sub)]

Set the input to display on the screen.

[HDMI1] / [HDMI2] / [DisplayPort] / [DVI-D] / [SLOT] / [PC]

■ [Sound output]

Set the terminal to output audio.

[Off] / [Main] / [Sub] / [AUDIO IN1] / [AUDIO IN2]

2-3 [Picture by picture] detailed settings

■ [Picture location]

Set the display position of the screen.

[Upper/Lower] / [Left/Right]

■ [Input(Upper)], [Input(Lower)] or [Input(Left)], [Input(Right)]

Set the input to display on the screen.

[HDMI1] / [HDMI2] / [DisplayPort] / [DVI-D] / [SLOT] / [PC]

■ [Sound output]

Set the terminal to output audio.

[Off] / [Upper] / [Lower] (or [Left] / [Right]) / [AUDIO IN1] / [AUDIO IN2]

Note

- The multi input display does not support interlace signal.

3. [Screen type]: [Multi screen display]

1 to 10 displays can be aligned in horizontal direction and vertical direction respectively, and those displays are regarded as one group. The enlarged image is shown on the combined display.

[Multi display settings] - submenu screen
([Multi screen display])

| Multi display settings | |
|------------------------|----------------------|
| Multi screen display | Off |
| Multi input display | Off |
| Screen type | Multi screen display |
| Horizontal scale | 2 |
| Vertical scale | 2 |
| Bezel H adjustment | 0 |
| Bezel V adjustment | 0 |
| Location | A1 |

Note

- The settings are memorised separately for each input terminal.
- When [Multi screen display] is set to [Off], adjust to the same angle of view for [Position] (see page 45). Then, set [Multi screen display] to [On]. Again, make fine adjustment of the angle of view for [Position].
- The [Position] menu can be adjusted in the multi screen display status.
- In multi screen setup, the aspect is set to [Full].
- For USB input, [Horizontal scale] and [Vertical scale] can be set only with the following combinations.
1 × 2, 1 × 3, 1 × 4, 2 × 1, 2 × 2, 3 × 1, 4 × 1

■ [Horizontal scale]

Set the horizontal scale in the multi screen display.

1 to 10

■ [Vertical scale]

Set the vertical scale in the multi screen display.

1 to 10

Example:

[Horizontal scale] [5] and [Vertical scale] [5] is set in the multi screen display



■ [Bezel H adjustment] / [Bezel V adjustment]

Adjust the area of image hidden in the joint horizontally and vertically respectively.

0 to 100

Display example:

Setting value: 0

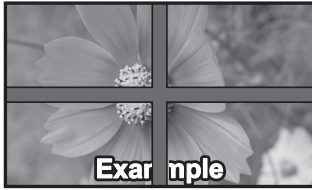

Displays the entire image including the joint area. (Suitable when displaying character information on PC.)

Setting value: 100



Does not display the image of the joint area. (Suitable when displaying motion pictures.)

■ [Location]

Assign screen positions on the multi-screen.

Example:

[Horizontal scale] [10], [Vertical scale] [10]

| | | | | |
|------|------|------|------|------|
| A1 | A2 | | A9 | A10 |
| B1 | B2 | | B9 | B10 |
| | | | | |
| I1 | I2 | | I9 | I10 |
| J1 | J2 | | J9 | J10 |

Select from A1 - J10.

- The displayed content for setting changes according to the settings for the [Horizontal scale] and [Vertical scale].
- By setting [Multi screen display] to [Off], it is possible to check the location on the screen while the setting menu is displayed.
- If [Image rotation] is set to [180 degrees], the enlarged location also rotates. (see page 87)

Portrait settings

This function displays input images by rotating 90°.

Note

- Set to the input other than [Screen Transfer] / [MEMORY VIEWER], and then set [Portrait settings].
- For video or picture you want to display, use the ones with 16:9 resolutions.
- About playing back with USB input, refer to “Using “USB media player”” (see page 111).
- While this menu is displayed, aspect mode will be [16:9].

[Portrait settings] - submenu screen

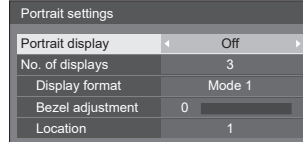

■ [Portrait display]

[Off]:

Disables portrait display.

[On]:

Enables portrait display.

When it is set to [On], aspect mode will be [16:9].

■ [No. of displays]

Set the number of displays comprising the portrait display.

1, 3

■ [Display format]

[Mode 1]:

Displays images without missing portion, however, some portion of the input images on the right and left is cut.

[Mode 2]:

Displays the entire input images, however, some portion of the images on top and bottom is not displayed.

[Mode 3]:

Displays the entire input images so that the image is displayed without missing portion.

Note

- [Mode 1] and [Mode 2] keep the aspect ratio 16:9 but [Mode 3] doesn't.

■ [Bezel adjustment]

Adjusts the area of image hidden in the joint area on the portrait screen.

0 to 100

■ [Location]

Assign the positions of portrait screens.

1 to 3

Portrait screen display example



- When [Portrait display] is set to [Off], the enlarged position can be confirmed on the screen if [No. of displays] is set to [3].

Note

- The settings are memorised separately for each input terminal.
- It is possible to set [Display format], [Bezel adjustment] and [Location] when [No. of displays] is [3].
- This menu will be greyed out and cannot be set under the following conditions.
 - When [Multi screen display] is [On] (see page 55)
 - When [USB media player settings] - [Schedule play function] is [Enable] (see page 81)
- When [Portrait display] is [On], the aspect mode cannot be changed. (see page 40)
- For 98 and 86 inch models, this setting is displayed only when the main software version is 3.0000 or later.

Signal

Examples of [Signal] submenu screen

When HDMI is selected

| Signal | |
|---------------------------|-------------|
| YUV/RGB-in select | YUV |
| Cinema reality | Off |
| Noise reduction | Auto |
| MPEG noise reduction | Off |
| Signal range | Full(0-255) |
| Frame creation | Off |
| Dynamic backlight control | Off |
| EDID select | 4K/60p/HDR |
| Dynamic range | Auto |
| Colour gamut | Auto |
| H-freq. | 33.72 kHz |
| V-freq. | 60.00 Hz |
| Dot clock freq. | 74.18 MHz |
| Signal format | 1080/60i |
| HDCP status | None |

When DisplayPort is selected

| Signal | |
|---------------------------|-------------|
| YUV/RGB-in select | YUV |
| Cinema reality | Off |
| Noise reduction | Auto |
| MPEG noise reduction | Off |
| Signal range | Full(0-255) |
| Frame creation | Off |
| Dynamic backlight control | Off |
| H-freq. | 33.72 kHz |
| V-freq. | 60.00 Hz |
| Dot clock freq. | 74.18 MHz |
| Signal format | 1080/60i |
| HDCP status | None |

When DVI-D / DIGITAL LINK / SLOT is selected

| Signal | |
|---------------------------|-------------|
| YUV/RGB-in select | YUV |
| Cinema reality | Off |
| Noise reduction | Auto |
| MPEG noise reduction | Off |
| Signal range | Full(0-255) |
| Frame creation | Off |
| Dynamic backlight control | Off |
| H-freq. | 33.72 kHz |
| V-freq. | 60.00 Hz |
| Dot clock freq. | 74.18 MHz |
| Signal format | 1080/60i |
| HDCP status | None |

When PC is selected

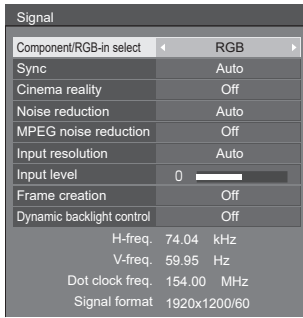

When Screen Transfer is selected

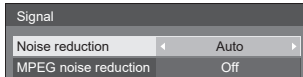

When USB / MEMORY VIEWER is selected

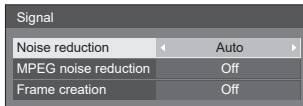

Note

- [Signal] setup menu displays a different setting condition for each input signal.
- Menu that cannot be adjusted is greyed out.

■ **[Component/RGB-in select]**

This menu is displayed at PC signal input.
Select to match the signals from the source connected to PC IN terminal.

[Component]:

YPbPr/YCbCr signals

[RGB]:

RGB signals

■ **[YUV/RGB-in select]**

This menu is displayed at HDMI 1, HDMI 2, DisplayPort, DIGITAL LINK, DVI-D IN and SLOT inputs.

Select to match the signals from the source connected to each terminal.

[Auto]:

YUV/RGB setting is automatically switched.

[YUV]:

YUV signals

[RGB]:

RGB signals

Note

- Set for each input terminal (HDMI 1, HDMI 2, DisplayPort, DIGITAL LINK, DVI-D IN, SLOT).
- With DIGITAL LINK input, it is possible to set to [YUV] and [RGB] only. It cannot be set to [Auto].

■ **[Sync]**

This menu is displayed at PC IN input.

Setting RGB/PC sync signal

[Auto]:

The H and V sync or synchronized signal is automatically selected.

[on G]:

Uses a synchronized signal on the Video G signal, which is input from the G connector.

[HV sync]:

Uses a synchronized signal on the Video HD/VD signal, which is input from the HD/VD connector.

Setting Component sync signal

[Auto]:

The H and V sync or synchronized signal is automatically selected.

[on Y]:

Uses a synchronized signal on the Video Y signal, which is input from the Y connector.

[HV sync]:

Uses a synchronized signal on the Video HD/VD signal, which is input from the HD/VD connector.

■ **[Cinema reality]**

Faithfully reproduces videos shot with cinema films.
Set this to [Off] normally.

Note

- In [ENGLISH(US)] OSD language, [Cinema reality] is displayed as [3:2 PULLDOWN].
- If [Cinema reality] is set to [On], videos including movies shot at 24 frames per second are reproduced more naturally.
- If the video is unnatural with [On] set, set it to [Off].

■ **[Noise reduction]**

Reduces picture noise.

[Off]:

Disables [Noise reduction].

[Min], [Mid], [Max]:

Sets strength of [Noise reduction].

[Auto]:

[Noise reduction] will be automatically selected from [Min], [Mid] or [Max].

■ **[MPEG noise reduction]**

Reduces block noise and mosquito noise on MPEG videos.

[Off]:

Disables [MPEG noise reduction].

[Min], [Mid], [Max]:

Sets strength of [MPEG noise reduction].

■ [Input resolution]

This menu is displayed at PC IN input.

Set the resolution of PC input. This setting is necessary only when this unit cannot correctly detect the resolution of PC input.

The setting can be changed when the applicable signals are received. The setting combinations are as follows.

- [Auto] / [1024x768] / [1280x768] / [1360x768] / [1366x768]
- [Auto] / [1400x1050] / [1680x1050]
- [Auto] / [1600x1200] / [1920x1200]

Note

- Make each adjustment (such as [Auto setup]) on the [Position] menu as necessary. (see page 45)

■ [Signal range]

This menu is displayed at HDMI1, HDMI2, DisplayPort, DIGITAL LINK, DVI-D IN and SLOT inputs. Switches the dynamic range to match the signals from the source connected to each terminal.

[Video(16-235)]:

If the input signal is the video range

Example: HDMI terminal output for DVD player

[Full(0-255)]:

If the input signal is full range

Example: HDMI terminal output for personal computer

[Auto]:

Switches the dynamic range automatically between [Video(16-235)] and [Full(0-255)] according to the input signal.

Note

- [Auto] can be selected at HDMI, DisplayPort, DIGITAL LINK and SLOT signal inputs.

■ [Input level]

This menu is displayed at PC IN input.

Adjustment of parts which are extremely bright and hard to see.

-16 to +16:

(Level low) – (Level high)

■ [Frame creation]

(98-inch model | 86-inch model | 75-inch model)

only)

Improves motion picture quality. Select [Off] when the motion picture looks unnatural.

[Off]:

Disables [Frame creation].

[On]:

Enables [Frame creation].

Note

- [Frame creation] is a function for 98/86/75-inch models. This function is not available for 65/55/49-inch models.

■ [Dynamic backlight control]

Improves picture contrast and alleviates whiteness by controlling the back light when signals with the low average brightness level (APL) are input.

[On]:

Enables [Dynamic backlight control].

[Off]:

Disables [Dynamic backlight control].

Note

- The screen may become dark if menu operation or input signal switching is performed while the on-screen menu is being displayed with this function set to [On]. Hiding the on-screen menu will restore the screen to the appropriate brightness.
- If the [Dynamic backlight control] setting is different for each input, the screen brightness may change by switching input.
- Depending on the displayed image, the screen may flicker. If this annoys you, set [Dynamic backlight control] to [Off].

■ [EDID select]

This menu is displayed in HDMI 1 and HDMI 2 inputs. EDID data of each terminal is switched.

[4K/60p/SDR]:

Sets EDID compatible with 4K video signals (Max. 4 096 x 2 160 dots, Max. vertical operation frequency 60 Hz).

This EDID supports SDR (Standard Dynamic Range). HDR (High Dynamic Range) is not supported.

[4K/60p/HDR]:

Sets EDID compatible with 4K video signals (Max. 4 096 x 2 160 dots, Max. vertical operation frequency 60 Hz).

This EDID supports HDR (High Dynamic Range).

[4K/30p]:

Sets EDID compatible with 4K video signals (Max. 4 096 x 2 160 dots, Max. vertical operation frequency 30 Hz).

[2K]:

Sets EDID compatible with 2K video signals (Max. 1 920 x 1 200 dots).

Note

- If [4K/60p/SDR] or [4K/60p/HDR] is selected and pictures are not displayed correctly during 4K video signal input, switch the setting to [4K/30p].
- If [4K/60p/SDR], [4K/60p/HDR] or [4K/30p] is selected and pictures are not displayed correctly during 2K or lower video signal input, switch the setting to [2K].
- For details of signals written in EDID of [4K/60p/SDR], [4K/60p/HDR], [4K/30p] and [2K], see "Preset Signals" (see page 138).

■ [Dynamic range]

This menu is displayed in HDMI 1 and HDMI 2 inputs. Switches the dynamic range.

[Auto]:

Sets automatically according to the AVIInfoFrame information.

[HDR(PQ)]

Sets the dynamic range in compatible with HDR (PQ (Perceptual Quantization)).

[HDR(HLG)]:

Sets the dynamic range in compatible with HDR (HLG (Hybrid Log Gamma)).

[SDR]:

Sets the dynamic range in compatible with SDR.

■ [Colour gamut]

This menu is displayed in HDMI 1 and HDMI 2 inputs. Switches the colour gamut.

[Auto]:

Sets the colour gamut automatically according to the ITU-2020 emu. information of AVIInfoFrame.

[Native]:

Displays with the colour space unique to this unit.

[ITU-2020 emu.]:

Displays with the colour space close to the ITU-R BT2020 standard.

■ Input signal display

Displays the frequency and the type of the current input signal.

| | | |
|-----------------|----------|-----|
| H-freq. | 33.72 | kHz |
| V-freq. | 60.00 | Hz |
| Dot clock freq. | 74.18 | MHz |
| Signal format | 1080/60i | |
| HDCP status | None | |

Display range:

Horizontal (15 kHz – 135 kHz)

Vertical (24 Hz – 120 Hz)

The dot clock frequency is displayed when Digital and PC signal are input.

The HDCP status information is displayed when digital signals are input.

Power on settings

Makes various settings at power-on.

[Power on settings] - submenu screen

| Power on settings | |
|------------------------------------|-------------|
| Initial input | ← Off → |
| Initial startup | Last memory |
| Initial VOL function | Off |
| Initial VOL level | 0 |
| Power ON screen delay | Off |
| Information(No activity power off) | Off |
| Information(Power management) | Off |
| Information(Display upside-down) | Off |

■ [Initial input]

Sets the input at power-on.

[Off] / [HDMI1] / [HDMI2] / [DisplayPort] / [DIGITAL LINK] / [DVI-D] / [SLOT] / [PC] / [Screen Transfer] / [USB] / [MEMORY VIEWER] / [Multi input display]

Note

- When [Input lock] is set to the item other than [Off], this menu will be greyed out and cannot be set. (see page 74)

■ [Initial startup]

Sets the power status of the main unit when the power plug is inserted/extracted, or when the power is restored from instantaneous interruption due to blackout, etc.

[Last memory]:

Restored to the state before the power is turned off.

[On]:

Restored to the power-on state. (power indicator: green)

[Standby]:

Restored to the standby state. (power indicator: red / orange)

Note

- When multiple units are installed, it is recommended to select [Standby] to reduce the load when the power is restored.

■ [Initial VOL function]

Enables/Disables the volume setting function at power-on.

[Off]:

Volume before power-off

[On]:

Volume set for [Initial VOL level]

■ [Initial VOL level]

Sets the sound volume when [Initial VOL function] is enabled.

Note

- The sound is output with the set volume when [Initial VOL function] on the menu is in [On] state.
- When [Maximum VOL function] is set to [On], the volume cannot be set to the level higher than the level set for [Maximum VOL level].

■ [Power ON screen delay]

When multiple displays are installed and are turned on simultaneously, this function distributes the load of power by delaying the power supply timing of each display. Setting is required for each display.

[Off]:

The powers are supplied at the same time as power-on.

[Auto]:

The delay time is automatically set according to the numbers set for display IDs.

The delay time is determined by multiplying a display ID by 0.3 seconds.

Example: If the display ID is 3, the delay time is 0.9 seconds.

1 - 30:

Sets the delay time (sec.). The powers are supplied to the display with the set time of delay after power-on.

Note

- The power indicators blink green from start to end of the delay operation process.
- This function also works when the power plug is inserted/extracted, or when the power is restored from instantaneous interruption due to blackout, etc.

■ [Information(No activity power off)]

Sets the display/non-display of the no-activity-auto-power-off warning message when the power is turned on.

[On]:

The warning message is displayed when the power is turned on.

[Off]:

The warning message is not displayed when the power is turned on.

Note

- This setting is enabled when [No activity power off] is [Enable]. (see page 74)

■ [Information(Power management)]

Sets the display/non-display of a message that tells the power has been turned off by the power management function when the power is turned on.

[On]:

The message is displayed when the power is turned on.

[Off]:

The message is not displayed when the power is turned on.

Note

- This setting is enabled when "Power management" function is [On]. (see page 69)

■ [Information(Display upside-down)]

Sets the display/non-display of a message that tells the unit is not installed in the correct orientation when the power is turned on.

(About [Display orientation], see page 86)

[On]:

The message is displayed when the power is turned on.

[Off]:

The message is not displayed when the power is turned on.

Note

- If a reverse installation message is displayed, other messages at power-on are not displayed.
- For 98 and 86 inch models, this setting is displayed only when the main software version is 3.0000 or later.

Input search

When a signal is not detected, another input with a signal is automatically selected.

Note

- MEMORY VIEWER / Screen Transfer input is excluded from this function.

| Input search | |
|------------------|------------|
| Input search | ← Custom → |
| 1st search input | (None) |
| 2nd search input | (None) |

■ [Input search]

[Off]: When there is no signal, the input is not switched automatically.

[All inputs]: Searches all inputs and switches to an input with a signal.

Input search is executed in the following order.

Example: When the current input is HDMI1

[HDMI2] → [DisplayPort] → [DIGITAL LINK] → [DVI-D] (or [SLOT]) → [PC] → [USB] → [HDMI1] →

Note

- The inputs set to [(Skip)] in [Input label] (see page 69) are skipped when searching.

[Custom]: Repeatedly searches [Current input], [1st search input] and [2nd search input] in order, and switches to an input with a signal.

[Input detection]: Monitors the inputs set to [On], detect the status change from no signal to signal present, and switches to the input.

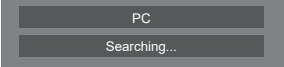

[Searching...] is displayed during the input search.

■ [Input search]: [Custom]

[1st search input], [2nd search input]

Set the input to search when [Custom] is selected.

[HDMI1] / [HDMI2] / [DisplayPort] / [DIGITAL LINK] / [DVI-D] / [SLOT] / [PC] / [USB] / [(None)]

■ [Input search]: [Input detection]

| Input search | |
|----------------|-----------------|
| Input search | Input detection |
| HDMI1 | Off |
| HDMI2 | Off |
| DisplayPort | Off |
| DIGITAL LINK | Off |
| DVI-D | Off |
| PC | Off |
| Changing delay | Off |

Sets the input to monitor during [Input detection].

[HDMI1] / [HDMI2] / [DisplayPort] / [DIGITAL LINK] / [DVI-D] / [PC]

[Off]: The input is not monitored.

[On]: The input is monitored.

■ [Changing delay]

Sets the delay time until the input is switched during [Input detection].

[Off]: Switches the input if a signal is interrupted even for a very short period.

1 – 10: Sets the delay time (sec.).

Switches the input when the set time has elapsed after detecting no signal is present.

However, if the detection period during which no signal is present is shorter than the set delay time, the input is not switched.

Note

- [Input detection] is the function that automatically switches the input as below by monitoring the presence of signal for the set input.
 - If a video signal is input to the set input that is not displayed (When the status has changed from signal absent to signal present.), the input is selected and switched.

- If no signal is detected for the displayed input, the setting switches to the set input to which a signal is input. Also, if no signal is present for the displayed input when the power is turned on or when the input is switched, the setting switches to the set input to which a signal is input. When signals are input to multiple set inputs, the priority order as default (immediately after power-on) is as follows: HDMI1, HDMI2, DisplayPort, DIGITAL LINK, DVI-D, PC.

In the other case (When the input is switched after power-on), the input displayed last takes priority.

- [Changing delay] is the function to prevent the accidental input switch during a short period, such as when the signal is interrupted due to the frequency change for the input signal while [Input detection] is operating.

If a signal is detected again within the set period (sec.), the input is not switched.

- [Input detection] may not operate correctly depending on the image playback device.

Note

- When set to the USB input, the unit determines no signal is present if the USB memory is not connected to the USB terminal.

In addition, even when a USB memory is connected, if there is no playable file, the unit determines no signal is present.

- This menu will be greyed out and cannot be set under the following conditions.

- [Failover/Failback] is set to the item other than [Off]. (see page 65)
- [Power management mode] is set to [Input detection]. (see page 69)
- [Input lock] is not set to [Off]. (see page 74)
- When [Setup] - [Image settings] - [No signal image settings] - [Display setting] is set to [On]. (see page 73)
- [SLOT power link] is set to [On]. (see page 88)
- If the input is changed by this function, the last input is selected when the power is turned on next time.

If you wish to retain the original input when the power is turned on, set [Initial input] to the original input. (see page 62)

Failover/Failback

Automatically switches to the backup input if an interruption of video occurs.

Note

- MEMORY VIEWER / Screen Transfer input is excluded from this function.

1. Setting the input change mode

■ [Input change mode]

[Off]:

Disables the Backup Input function.

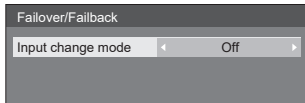

[Quick]:

Promptly switches to the backup input if an interruption of video occurs.

The backup video signal needs to be in the same format as the (main) input in use for viewing.

Upon switching to the backup input, the video and audio adjustment values for the (main) input used for viewing will be inherited.

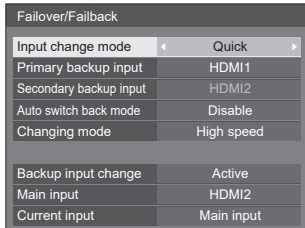

[Normal]:

Switches to the backup input if an interruption of video occurs.

The backup video signal does not need to be in the same format as the (main) input in use for viewing.

Upon switching to the backup input, the video and audio adjustment values for the backup input will be used.

1-1 [Input change mode]: [Quick] detailed settings

Promptly switches to the backup input if an interruption of video occurs, and enables switching between digital (HDMI1 / HDMI2) inputs.

Note

- This function will start operating once a video signal is detected by both the input in use for viewing and the backup input and the [Backup input change] item is displayed as [Active].
- This function may not operate correctly depending on the image playback device or video signal.

■ [Primary backup input]

Sets the first priority backup input.

(None) / [HDMI1] / [HDMI2] / [DisplayPort] / [DVI-D] / [SLOT]

The input that is of the same type as the one in use for viewing will be greyed out.

■ [Secondary backup input]

Sets the second priority backup input.

(None) / [HDMI1] / [HDMI2] / [DisplayPort] / [DVI-D] / [SLOT]

The input that is of the same type as the one in use for viewing will be greyed out.

■ [Auto switch back mode]

Sets whether or not to automatically return to the former (main) input when the former input video initially viewed is restored while viewing the video of the backup input enabled by the operation of the Backup Input function.

[Disable]:

Unreturned

[Enable]:

Returned

■ [Changing mode]

Set speed of input switching.

[High speed]:

If switching between the same signal formats, it is possible to switch within 1 second.

If switching between the different signal formats, picture noise is caused.

[Normal speed]:

If switching between the same signal formats, it is possible to switch within 2 seconds.

If switching between the different signal formats, it takes 3 to 4 seconds to switch but picture noise is not caused.

■ [Backup input change]

Displays whether or not operating conditions for the Backup Input function are met.

[Inactive]:

Indicates that the conditions are not met, and inactivates the Backup Input function.

[Active]:

Indicates that the conditions are met, and activates the Backup Input function.

■ [Main input]

Displays the (main) input set by switching input.

■ [Current input]

Displays whether the input currently in use for viewing is the (main) input set by switching input or the backup one.

Setting conditions

The following table describes restrictions (available combinations) on each setting item.

| | | Main | | | | |
|--------|--|--|-----------------|----|-----|--|
| | | HDMI1 HDMI2 DisplayPort DVI-D SLOT | DIGITAL LINK | PC | USB | |
| Backup | HDMI1 HDMI2 DisplayPort DVI-D SLOT | ○ | × | × | × | |
| | DIGITAL LINK | × | × | × | × | |
| | PC | × | × | × | × | |
| | USB | × | × | × | × | |
| | | | | | | |

○: Selectable for both Primary and Secondary.

×: Not selectable for neither Primary nor Secondary.

Recall display

Pressing <RECALL> displays any of the followings.

- When the main input is being used for viewing and the operating conditions for the Backup Input function are met.

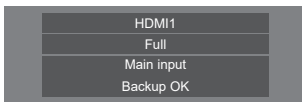

- When the backup input, enabled by the operation of the Backup Input function, is being used for viewing.

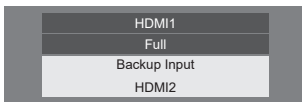

When the conditions for the Backup Input function are met, the following screen is displayed.

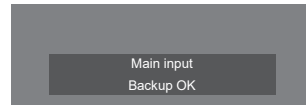

1-2 [Input change mode]: [Normal] detailed settings

Switches to the backup input if an interruption of video occurs.

Note

- This function will start operating once a video signal is detected by both the input in use for viewing and the backup input and the [Backup input change] item is displayed as [Active].

■ [Primary backup input]

Sets the first priority backup input.

(None) / [HDMI1] / [HDMI2] / [DisplayPort] / [DIGITAL LINK] / [DVI-D] / [SLOT] / [PC] / [USB]

The input that is of the same type as the one in use for viewing will be greyed out.

■ [Secondary backup input]

Sets the second priority backup input.

(None) / [HDMI1] / [HDMI2] / [DisplayPort] / [DIGITAL LINK] / [DVI-D] / [SLOT] / [PC] / [USB]

The input that is of the same type as the one in use for viewing will be greyed out.

■ [Auto switch back mode]

Sets whether or not to automatically return to the former (main) input when the former input video initially viewed is restored while viewing the video of the backup input enabled by the operation of the Backup Input function.

[Disable]:

Unreturned

[Enable]:

Returned

■ [Backup input change]

Displays whether or not operating conditions for the Backup Input function are met.

[Inactive]:

Indicates that the conditions are not met, and inactivates the Backup Input function.

[Active]:

Indicates that the conditions are met, and activates the Backup Input function.

■ [Main input]

Displays the (main) input set by switching input.

■ [Current input]

Displays whether the input currently in use for viewing is the (main) input set by switching input or the backup one.

Setting conditions

The following table describes restrictions (available combinations) on each setting item.

| | | Main | | |
|--------|--|--|----|-----|
| | | HDMI1 HDMI2 DisplayPort DIGITAL LINK DVI-D SLOT | PC | USB |
| Backup | HDMI1 HDMI2 DisplayPort DIGITAL LINK DVI-D SLOT | ○ | ○ | ○ |
| | PC | △ | × | △ |
| | USB | ○ | ○ | × |

- : Selectable for both Primary and Secondary.
- △: Selectable for either Primary or Secondary.
- ×: Not selectable for neither Primary nor Secondary.

Recall display

Pressing <RECALL> displays any of the followings.

- When the main input is being used for viewing and the operating conditions for the Backup Input function are met.

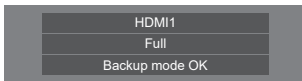

- When the backup input, enabled by the operation of the Backup Input function, is being used for viewing.

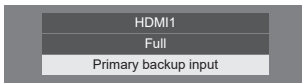

When the conditions for the Backup Input function are met, the following screen is displayed.

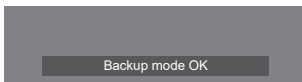

Note

- This menu will be greyed out and cannot be set under the following conditions.
 - [Input search] is set to the item other than [Off]. (see page 63)
 - [Setup] - [Image settings] - [No signal image settings] - [Display setting] is set to [On]. (see page 73)

- [Power management mode] is set to [Input detection]. (see page 69)
- [SLOT power link] is set to [On]. (see page 88)
- When set to the USB input, the unit determines video signals are interrupted by judging the USB memory is not connected to the USB terminal.
- This function may not operate correctly depending on the image playback device.

Screensaver

Alleviates the occurrence of afterimage when displaying still images or images with 4:3 aspect ratio for a long time.

[Screensaver] - submenu screen

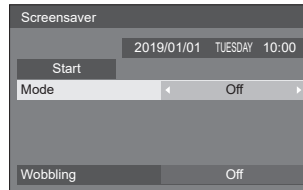

■ Screensaver settings

Screensaver operation

When the Screensaver is operating, the following 5 patterns are displayed full screen for 5 seconds each, and it will be repeated.

Black → Dark grey → Grey → Light grey → White → Light grey → Grey → Dark grey

To start Screensaver now

- ① Select [On] in [Mode].
- ② Select [Start] and press <ENTER>.
 - The Screensaver will be activated.

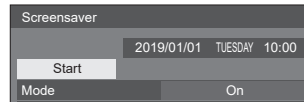

Note

- If the following buttons are pressed while the screen saver is operating, the screen saver is cancelled.

Remote control: <RETURN>

Unit: <MENU (Unit)> <INPUT (Unit)>
<+ (Unit)> <- (Unit)> ▲ ▼
<ENTER (Unit)>

- When the display is turned off, the Screensaver will be deactivated.

To set interval of Screensaver

- ① Select [Interval] in [Mode].
- ② Set [Periodic time].
 - Press ◀▶ to change the time by 15 minutes.
 - In [ENGLISH(US)] OSD language, [Periodic time] is displayed as [SHOW DURATION].

③ Set [Operating time].

- Press ◀▶ once to change the time by 1 minute. Keep pressing down to change the time by 15 minutes.
- In [ENGLISH(US)] OSD language, [Operating time] is displayed as [SAVER DURATION].

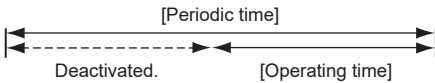
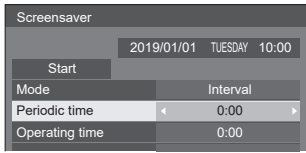

Note

- It is not possible to set the duration of [Operating time] longer than that of [Periodic time].

To set start and finish time of Screensaver

- ① Select [Time designation] in [Mode].
- ② Set [Start time] and [Finish time].
 - Press ◀▶ once to change the time by 1 minute. Keep pressing down to change the time by 15 minutes.
 - In [ENGLISH(US)] OSD language, [Time designation] is displayed as [TIME OF DAY].

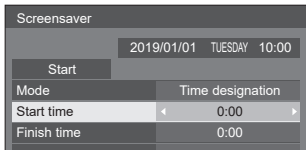

Note

- When the current time is displayed as [- -], set [Date and time] before setting [Start time] and [Finish time]. (see page 76)

To turn the power off after Screensaver

- ① Select [Standby after SCR saver] in [Mode].
- ② Set [Screensaver duration].
 - Press ◀▶ once to change the time by 1 minute. Keep pressing down to change the time by 15 minutes.
- ③ Select [Start] and press <ENTER>.
 - Screensaver will be activated and the power will be turned off (standby) at the time set.

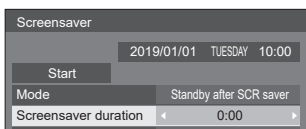

Note

- [Screensaver duration] can be set from 0:00 to 23:59.
When this is set to [0:00], [Standby after SCR saver] will not be activated.

■ [Wobbling]

Automatically shifts the display image to prevent image retention on the liquid crystal panel.

Setting this to [On] moves the screen position at certain intervals and displays the images.

Note

- When [Multi display settings] - [Multi screen display] is set to [On], [Wobbling] will not be activated. (see page 55)
- When [Portrait settings] - [Portrait display] is set to [On], [Wobbling] will not be activated. (see page 58)
- When this function is operating, part of the screen may appear to be missing.

Input label

This function can change the label of the Input signal to be displayed.

[Input label] - submenu screen

| Input label | |
|--------------|--------------|
| HDMI1 | HDMI1 |
| HDMI2 | HDMI2 |
| DisplayPort | DisplayPort |
| DIGITAL LINK | DIGITAL LINK |
| DVI-D | DVI-D |
| SLOT | SLOT |
| PC | PC |

| | |
|-----------------------|--|
| [HDMI1] | [HDMI1] / [DVD1] / [DVD2] / [DVD3] / [Blu-ray1] / [Blu-ray2] / [Blu-ray3] / [CATV] / [VCR] / [STB] / (Skip) |
| [HDMI2] | [HDMI2] / [DVD1] / [DVD2] / [DVD3] / [Blu-ray1] / [Blu-ray2] / [Blu-ray3] / [CATV] / [VCR] / [STB] / (Skip) |
| [DisplayPort] | [DisplayPort] / [DVD1] / [DVD2] / [DVD3] / [Blu-ray1] / [Blu-ray2] / [Blu-ray3] / [CATV] / [VCR] / [STB] / (Skip) |
| [DIGITAL LINK] | [DIGITAL LINK] / [DVD1] / [DVD2] / [DVD3] / [Blu-ray1] / [Blu-ray2] / [Blu-ray3] / [CATV] / [VCR] / [STB] / (Skip) |
| [DVI-D] | [DVI-D] / [DVD1] / [DVD2] / [DVD3] / [Blu-ray1] / [Blu-ray2] / [Blu-ray3] / [CATV] / [VCR] / [STB] / (Skip) |
| [SLOT] | [SLOT] / (Skip) |
| [PC] | [PC] / [DVD1] / [DVD2] / [DVD3] / [Blu-ray1] / [Blu-ray2] / [Blu-ray3] / [CATV] / [VCR] / [STB] / (Skip) |

(Skip): When <INPUT> is pressed, the input will be skipped.

Power management settings

Set each item to reduce power consumption.

This function works only for the input terminal that is currently selected.

[Power management settings] - submenu screen

| Power management settings | |
|-------------------------------|---------|
| Power management mode | Custom |
| No signal power off | Disable |
| HDMI1 power management | Off |
| HDMI2 power management | Off |
| DisplayPort power management | Off |
| DIGITAL LINK power management | Off |
| DVI-D power management | Off |
| PC power management | Off |
| Power save | Off |
| Extended standby mode | Off |
| Input detection | |
| Changing delay | Off |

1. Setting [Power management mode]

1-1 [Power management mode]: [On]

The following fixed values are set to the menu of power consumption reduction. Individual setting is not available.

[No signal power off]: [Enable]

[HDMI1 power management]: [On]

[HDMI2 power management]: [On]

[DisplayPort power management]: [On]

[DIGITAL LINK power management]: [On]

[DVI-D power management]: [On]

[PC power management]: [On]

[Power save]: [On]

1-2 [Power management mode]: [Custom]

The menu of the power consumption reduction is individually set. This setting is enabled when [Power management mode] is set to [Custom].

1-3 [Power management mode]: [Input detection]

Sets the power consumption reduction menu individually.

This is enabled when [Power management mode] is set to [Input detection]. This mode interlocks between the power management operation and the input detection function for operation. When this mode detects the change from without-signal state to with-signal state by monitoring input signals, the input signal detection function operates, and an input is automatically switched to the input. Also, if the current input signal disappears, it is automatically switched to another input. If all the input signals disappear, the power management function operates, and automatically turns the power off/on. This operation is performed between selected terminals.

Note

- Set the "Power management" function to [On] for terminals to operate this function.
- [Extended standby mode] is set to [On], and greyed out.

■ [No signal power off]

When this is set to [Enable], the power supply of the unit goes off automatically (standby) when there is no operation or sync signal for about 10 minutes.

Note

- When set to the USB input, the unit determines no signal is present if the USB memory is not connected to the USB terminal, or the connected USB memory does not contain any playable file.
- With Screen Transfer input, the unit determines no signal is present in standby status and when the PC is not connected to Screen Transfer.
- This function operates regardless of the [On] / [Off] settings of [No signal image settings].
- This function may not operate depending on the video output devices.

■ [HDMI1 power management]

When this function is set to [On], it operates under the following conditions to turn the power on or off automatically.

When no pictures (sync signal) are detected for 60 seconds or so at HDMI1 input:

Power is turned off (standby); the power indicator lights up orange.

When pictures (sync signal) are subsequently detected at HDMI1 input:

Power is turned on; the power indicator lights up green.

Note

- This function may not operate depending on the video output devices.

■ [HDMI2 power management]

When this function is set to [On], it operates under the following conditions to turn the power on or off automatically.

When no pictures (sync signal) are detected for 60 seconds or so at HDMI2 input:

Power is turned off (standby); the power indicator lights up orange.

When pictures (sync signal) are subsequently detected at HDMI2 input:

Power is turned on; the power indicator lights up green.

Note

- This function may not operate depending on the video output devices.

■ [DisplayPort power management]

When this function is set to [On], it operates under the following conditions to turn the power on or off automatically.

When no pictures (sync signal) are detected for 60 seconds or so at DisplayPort input:

Power is turned off (standby); the power indicator lights up orange.

When pictures (sync signal) are subsequently detected at DisplayPort input:

Power is turned on; the power indicator lights up green.

Note

- This function may not operate depending on the video output devices.

■ [DIGITAL LINK power management]

When this function is set to [On], it operates under the following conditions to turn the power on or off automatically.

When no pictures (sync signal) are detected for 60 seconds or so at DIGITAL LINK input:

Power is turned off (standby); the power indicator lights up orange.

When pictures (sync signal) are subsequently detected at DIGITAL LINK input:

Power is turned on; the power indicator lights up green.

Note

- This function may not operate depending on the video output devices.

■ [DVI-D power management]

When this function is set to [On], it operates under the following conditions to turn the power on or off automatically.

When no pictures (sync signal) are detected for 60 seconds or so at DVI-D input:

Power is turned off (standby); the power indicator lights up orange.

When pictures (sync signal) are subsequently detected at DVI-D input:

Power is turned on; the power indicator lights up green.

Note

- This function may not operate depending on the video output devices.

■ [PC power management] (DPMS function)

When this function is set to [On], it operates under the following conditions to turn the power on or off automatically.

When no pictures (HD/VD sync signals) are detected for 60 seconds or so at PC input:

Power is turned off (standby); the power indicator lights up orange.

When pictures (HD/VD sync signals) are subsequently detected at PC input:

Power is turned on; the power indicator lights up green.

Note

- This function is effective when [Sync] in [Signal] is set to [Auto] or [HV sync] and [Component/RGB-in select] are set to [RGB]. (see page 60)
- This function may not operate depending on the video output devices.

■ [Power save]

This function adjusts the brightness of the backlight to reduce power consumption.

[Off]:

The power save function does not operate.

[On]:

Backlight brightness is reduced.

■ [Extended standby mode]

Sets the operation in standby mode by the “Power management” function for the input terminal for which the “Power management” function is set to [On].

[Off]:

If a video signal (synchronized signal) is detected at the input terminal with which the standby mode is entered, the power is turned “ON” with the input.

[On]:

If a video signal (synchronized signal) is detected at any of the input terminals for which the “Power management” function is set to [On], the power is turned “ON”, and the input is switched to the detected input.

Note

- When [Input search] is [All inputs] or [Custom], the [Input search] function is prioritised. (The “Power management” function does not operate for each terminal.) (For details of [Input search] function, see page 63.)
- When [Failover/Failback] - [Input change mode] is set to items other than [Off], the [Failover/Failback] function is prioritised. (The “Power management” function does not operate for each terminal.) (For details of [Failover/Failback] function, see page 65.)

■ [Changing delay]

Sets the delay time until the input is switched when [Power management mode] is [Input detection].

[Off]:

Switches the input if a signal is interrupted even for a very short period.

1 to 10:

Sets the delay time (sec.). Switches the input when the set time has elapsed after detecting no signal is present. However, if the detection period during which no signal is present is shorter than the set delay time, the input is not switched.

Note

- The operation when [Input detection] is selected is the same as the operation when [Input search] is set to [Input detection]. (see page 64)

Audio input select

[Audio input select] - submenu screen

| Audio input select | |
|--------------------|-----------------|
| HDMI1 | HDMI1 |
| HDMI2 | HDMI2 |
| DisplayPort | DisplayPort |
| DIGITAL LINK | DIGITAL LINK |
| DVI-D | AUDIO IN1 |
| SLOT | SLOT |
| PC | AUDIO IN2 |
| Screen Transfer | Screen Transfer |

Video input

Audio input

| | |
|------------------------|--|
| HDMI1 | HDMI1 / AUDIO IN1 / AUDIO IN2 / No audio |
| HDMI2 | HDMI2 / AUDIO IN1 / AUDIO IN2 / No audio |
| DisplayPort | DisplayPort / AUDIO IN1 / AUDIO IN2 / No audio |
| DIGITAL LINK | DIGITAL LINK / AUDIO IN1 / AUDIO IN2 / No audio |
| DVI-D / PC | AUDIO IN1 / AUDIO IN2 / No audio |
| SLOT | SLOT / AUDIO IN1 / AUDIO IN2 / No audio |
| Screen Transfer | Screen Transfer / AUDIO IN1 / AUDIO IN2 / No audio |

- No audio: No audio input (Mute)

When the setting for the audio input has been changed from the factory settings, the audio input is displayed as below.

| |
|-----------|
| HDMI1 |
| Full |
| AUDIO IN1 |

HDMI-CEC settings

Set for HDMI-CEC function.

For details of HDMI-CEC function, refer to "Using HDMI-CEC function". (see page 127)

[HDMI-CEC settings] - submenu screen

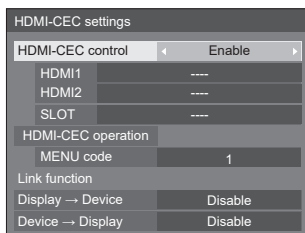

■ [HDMI-CEC control]

Enables/Disables the HDMI-CEC function.

[Disable]: Disables HDMI-CEC control.

[Enable]: Enables HDMI-CEC control.

Note

- Set to [Enable] to operate HDMI-CEC compatible device with remote control of the unit.

■ [HDMI1]

Displays the device to operate when HDMI-CEC compatible device is connected to HDMI 1 terminal.

The control subject can be changed with ◀▶.

Note

- When there is no connected device, [----] will be displayed.

■ [HDMI2]

Displays the device to operate when HDMI-CEC compatible device is connected to HDMI 2 terminal.

The control subject can be changed with ◀▶.

Note

- When there is no connected device, [----] will be displayed.

■ [SLOT]

Displays the device to operate when HDMI-CEC compatible device is connected to SLOT terminal.

Note

- The setting item [SLOT] is displayed only when the function board is inserted into the SLOT. When the HDMI-CEC compatible SLOT is not connected, [----] will be displayed.
- For 98 and 86 inch models, this setting is displayed only when the main software version is 3.0000 or later.

■ [HDMI-CEC operation]

Displays the operation screen of the HDMI-CEC compatible device.

Press <RETURN> to hide the operation screen.

■ [MENU code]

Changes the code to assign for the [MENU] operation on the HDMI-CEC operation screen.

Adjust the code to that of the connected HDMI-CEC compatible device.

■ [Display → Device]

Enables/Disables this unit to perform interlocking control of the HDMI-CEC compatible device.

[Disable]:

Disables this unit to perform interlocking control of the HDMI-CEC compatible device.

Even if the power status of this unit changes, the power status of the device will not be affected.

[Power off]:

Turning this unit off (standby) turns off (standby) all the devices connected to the HDMI 1, HDMI 2 or SLOT terminal. The power-on operation is not interlocked.

[Power off / on]:

The device turns off/on (standby) in conjunction with the power-off/on (standby) operation of this unit.

Note

- For details of operation, refer to "Using HDMI-CEC function". (see page 127)

■ [Device → Display]

Enables/Disables the HDMI-CEC compatible device to perform interlocking control of this unit.

[Disable]:

Disables the device to perform interlocking control of this unit.

Even if the power status of the device changes, the power status of this unit will not be affected.

[Power on]:

Turning on the device turns on this unit, and the input (HDMI1 / HDMI2 / SLOT) is switched to that of the device.

[Power off / on]:

The power status of this unit interlocks with the power-off/on operation of the device.

Note

- For details of operation, refer to "Using HDMI-CEC function". (see page 127)
- Input will not be switched when [Setup] - [Input lock] is set.
- When the function board is inserted to SLOT and [DVI-D/SLOT select] is set to [DVI-D], the input is not switched to SLOT input.

Image settings

Sets the image displayed on the screen when the power is turned on or no signal is input.

[Image settings] - submenu screen

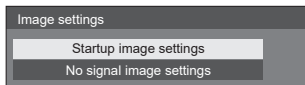

[Startup image settings]:

Sets the image displayed when the power is turned on.

[No signal image settings]:

Sets the image displayed when there is no signal at the selected input terminal.

Conditions of the image that can be set in [Read user image]

- Image size: 3 840 x 2 160, 1 920 x 1 080 only
- jpg files / bmp files (except for the ones that cannot be played back with USB media player (see page 112))

File and folder names are displayed on the file list with conditions as below.

– If a file or folder is placed directly under the root directory of the USB device.

- Up to 246 characters of file name (including the extension) are properly displayed.

Note that the file list may disappear due to the display time of the on-screen menu before the entire display of file names completely appears.

- Up to 244 characters of folder name are properly displayed.
 - If the folder is placed hierarchically, the number of characters displayed decreases by the number of characters for the file path (folder information).

– Only the files with file names described with ASCII characters excluding control code are displayed.

Note

- [Picture] cannot be adjusted when setting the startup image.
- Only [Backlight], [Gamma] and [Colour temperature] can be adjusted when setting the no-signal image.
- Images displayed for the startup image and no-signal image may slightly differ from images confirmed on the computer.
- When [No signal image settings] is set to [On], [Input search] and [Failover/Failback] will be disabled, and the menu will be greyed out.

■ [Startup image settings] / [No signal image settings]

Operate [No signal image settings] in the same way as [Startup image settings].

[Startup image settings] - submenu screen

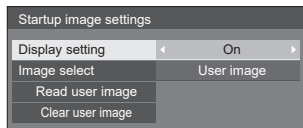

[Display setting]

Sets the image display when the power is turned on.

[Off]: Disables each image setting function.

[On]: Enables each image setting function.

Note

- When no-signal image is displayed, the screen position moves at certain intervals and images are displayed to alleviate image retention on the LCD panel.
- Shifts the display position regardless of the setting of [Wobbling] (see page 68).
- When this function is operating, part of the screen may appear to be missing.

[Image select]

Select the image to display.

[Default image]: Panasonic logo (blue background)

[User image]: Image registered by the user

Note

- Only when [Default image] is displayed, the logo automatically rotates according to the [Display orientation] (see page 86) setting or installation orientation.
- When [User image] is selected, the image does not rotate according to the [Display orientation] setting or installation orientation. Prepare an image of 3 840 × 2 160 or 1 920 × 1 080 aspect ratio compatible with the installation orientation.
- [Default image] of [No signal image settings] is the Panasonic logo (black background).

[Read user image]

Register the image read from a USB memory device.

[Read user image] - submenu screen

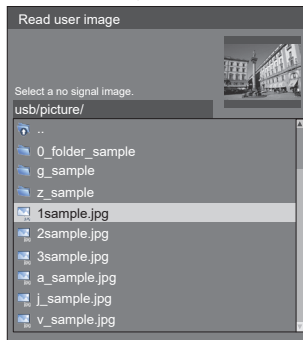

Note

- Set the input to something other than [USB] or [MEMORY VIEWER], and read the image.
- One user image can be registered for [Startup image settings] and [No signal image settings] respectively.
- Do not turn the power off while reading the user image.
- The selected image is previewed on the [Read user image] submenu screen.
- When USB memory device is not connected to the USB terminal, [Read user image] is greyed out and cannot be selected.
- If starting to read the image while creating the preview image, an access error will occur, and the image may not be recognized as a image file.
Confirm the preview image display, and then start reading process.
- The displayed file names are restricted as follows.
 - Applicable extension: jpg, jpe, jpeg or bmp
 - The file name is not “.jpg”, “.jpe”, “.jpeg”, or “.bmp” which start with dot (.).
- Depending on the OS setting, folders or files in the USB memory invisible on your computer may be displayed on this unit.
- If an image of 3 840 × 2 160 is registered for [Startup image settings], and [Image select] is set to [User image], the start-up time will be longer at power-on.
- If an image of 3 840 × 2 160 is registered for [No signal image settings], the displayed image quality will be equivalent of 1 920 × 1 080.

[Clear user image]

Clears the image read in [Read user image].

[Startup image settings] - submenu screen

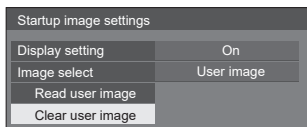

Note

- When there is no [User image] that have been read, [Clear user image] is greyed out and cannot be selected.
- When [Image select] is set to [User image], performing [Clear user image] will change the setting of [Image select] to [Default image].

Input lock

Disables [Input] operation by locking the input.

[Off] / [HDMI1] / [HDMI2] / [DisplayPort] / [DIGITAL LINK] / [DVI-D] / [SLOT] / [PC] / [Screen Transfer] / [USB] / [MEMORY VIEWER] / [Multi input display]

Note

- Input switch can be used when this is set to [Off].

Off-timer function

Enables / disables [Off-timer function].

[Enable]:

Enables [Off-timer function].

[Disable]:

Disables [Off-timer function].

Note

- When [Disable] is set, the Off-timer is cancelled.

No activity power off

When this function is set to [Enable], the power is turned off (standby) automatically when there is no operation of the Display for 4 hours.

Starting from 3 minutes before the turn off, the remaining time will be displayed.

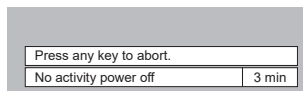

When the power is turned off due to this function, a message [Last turn off due to 'No activity power off'.] is displayed next time the power is turned on.

When the image set in [No signal image settings] (see page 73) is displayed, remaining time is not displayed even when the power is going to be turned off in 3 minutes. Instead, the image is displayed until the power is turned off.

Note

- While the screensaver is running, this function is disabled.

OSD language

Select your preferred language.

Selectable languages

English(UK)

Deutsch

Français

Italiano

Español

ENGLISH(US)

中文 : Chinese

日本語 : Japanese

Русский : Russian

Set up timer

Sets the program to turn the power on with the specified time and video input, or to turn the power off at the specified time. Up to 20 programmes can be set.

Note

- When the current time is displayed as [- -], set [Date and time] before setting [Set up timer]. (see page 76)
- When multiple programs are set at the same time, the program with the smallest program number is enabled.
- If [Power mode] is set to [Power on], executing the program at power-on will switch to the input set for [Input].

[Set up timer] - submenu screen

Setting Example:

Program 1, Every Monday, 12:00,

Power On, Input: HDMI1

The screenshot shows the 'Set up timer' menu with the following fields and callouts:

- 1: Program number (1)
- 2: Timer function (On)
- 3: Day (Custom)
- 4: Time (12:00)
- 5: Power mode (Power on)
- 6: Input (HDMI1)

- 1 Set the program number.
- 2 To execute the program, set to [On].
The program is disabled when [Off] is set.
- 3 Set the day.
 - [Everyday]:
Executes the program every day.
 - [Weekday]:
Executes the program from every Monday to Friday.
 - [Weekend]:
Executes the program on Saturdays and Sundays.
 - [Custom]:
Executes the program on selected days. (Refer to "Customized setting for days of the week".)
- 4 Set the time.
Pressing ◀▶ once changes time 1 minute.
Pressing continuously changes time by 15 minutes.
- 5 Set the power On/Off.
- 6 Set the input.

■ Customized setting for days of the week

- 1 Set [Day] to [Custom].
- 2 While [Day] is selected, press <ENTER>.

The [Day] screen appears.

The 'Day' screen shows a list of days with checkboxes:

- All
- MONDAY
- TUESDAY
- WEDNESDAY
- THURSDAY
- FRIDAY
- SATURDAY
- SUNDAY

- ▲▼◀▶ Moves the focus.
 - <VOL +> Selects days. (Put check marks on days to select.)
 - <VOL -> Cancels the day selection. (Delete a check mark if it has been put.)
 - <ENTER> Saves the current setting, and returns to the timer setup screen.
 - <RETURN> Returns to the timer setup screen without saving the current setting.
- 3 Change the setting, press <ENTER>, and return to the timer setup screen.
 - With [All], all days are selected/cancelled.

Note

- Use the remote control for the "Customized setting for days of the week" operation.
- If the [Day] screen is deleted without pressing <ENTER>, the setting is not saved.

Date and time

Set date and time. ([- -] shows no programme is set.)

[Date and time] - submenu screen

| Date and time | |
|-----------------------------|---------------|
| 2019/01/01 TUESDAY 10:00 | |
| Set | |
| Year | 2019 |
| Month | 1 |
| Day | 1 |
| Hour | 10 |
| Minute | 0 |
| Clock display Off | |
| Synchronize display setting | |
| Synchronize display | Off |
| Parent or child setting | Child |
| NTP status | |
| NTP synchronization | Off |
| Time zone | (GMT + 00:00) |

■ Set date and time

- ① Select [Year / Month / Day / Hour / Minute].
- ② Set the selected item.



| Date and time | |
|--------------------------|------|
| 2019/01/01 TUESDAY 10:00 | |
| Set | |
| Year | 2019 |
| Month | 1 |
| Day | 1 |
| Hour | 10 |
| Minute | 0 |

- ③ Select [Set] and press <ENTER>.

| Date and time | |
|----------------------------|------|
| 2019/02/06 WEDNESDAY 18:00 | |
| Set | |
| Year | 2019 |
| Month | 2 |
| Day | 6 |
| Hour | 18 |
| Minute | 0 |

Note

- If the present date and time are not set, the time settings for [Set up timer], [Screensaver], etc. cannot be made.

- The present date and time setting is reset in the following case.

When the main unit is left unattended for 7 days or longer after the main unit is turned off with the <Main Power On / Off button>, the power plug is removed, or power failure has occurred, etc.

* If the unit is used for long periods or in a high temperature environment, days to reset may be shorter than 7 days.

- Date and time cannot be set when [Year / Month / Day / Hour / Minute] are set to [- -].

- The upper limit of date and time that can be set is, Year 2035, Month 12, Day 31, Hour 23 and Minute 59.

■ [Clock display]

Sets to display / hide the clock.

[Off]:

Hides the clock.

[On]:

Displays the clock.

Note

- The clock is displayed at the lower left of the screen when <RECALL> button is pressed.
Display duration is approx. 5 seconds.
- When current date and time is not set, the clock is not displayed even when [Clock display] is [On].

■ [Synchronize display setting]

Synchronizes the time of all the displays connected on the network.

Note

- This function does not operate if the displays to synchronize the time are not connected via a LAN.
- This function operates only when the devices connected via a LAN are connected with different IP addresses.
- The time synchronization operates only in power-on state or in schedule standby state.
- Normal operation is achieved only when the display synchronization function is enabled among the units.
If other devices are connected on the same network, operation may not be normal.

[Synchronize display]:

Enables/Disables display synchronization function.

[Parent or child setting]:

Set this unit to [Parent] or [Child] for display synchronization.

Operates when [Synchronize display] is [On].

[Parent]:

Set the time as a source of synchronization.

[Child]:

Synchronizes with the time of the parent.

Note

- When [Synchronize display] is [On], and [Parent or child setting] is [Child], date and time cannot be set.
- When [Synchronize display] is [On], and [Parent or child setting] is [Child], [NTP synchronization] off-operation is performed.
- If two or more displays with [Parent] set are present on one network, display synchronization does not operate properly.
- Time is not synchronized if no displays with [Parent] set is present on one network.
- Time is not synchronized if the time is not set for the display with [Parent] set on the network.

- Depending on the network environment, synchronization may be largely lost.
- Synchronization is not possible if a router is placed between the displays with [Parent] and [Child] set.
- Synchronization is not possible via a wireless LAN.

■ [NTP status]

Displays the current [NTP synchronization] and [Time zone] (see page 104) settings.

Note

- When [NTP synchronization] is set to [On], and if [Synchronize display] and [Parent or child setting] are set to [On] and [Child] respectively, [NTP synchronization] shows [--], and the off-operation is performed.
- When [NTP synchronization] is [On], date and time cannot be set.
- The settings for [NTP synchronization] and [Time zone] cannot be changed with this menu. Change the settings with WEB browser. (see page 104)
- [NTP synchronization] operates only in power-on state or in schedule standby state.

Network settings

Set when networking with a computer.

[Network settings] submenu will be displayed.

| Network settings | |
|--------------------------------|------------|
| Serial control | SERIAL IN |
| Network control | Off |
| Auto display name | Off |
| Display name | SQ1-000 |
| LAN setup | |
| Network status | |
| DIGITAL LINK mode | Auto |
| DIGITAL LINK(Ethernet control) | Enable |
| DIGITAL LINK status | |
| DIGITAL LINK menu | |
| AMX D. D. | Off |
| Crestron Connected™ | Off |
| Extron XTP | Off |
| USB memory network settings | Permit |
| LAN control protocol | Protocol 2 |
| Reset | |

■ [Serial control]

Selects the RS232-C control terminal.

[SERIAL IN]:

Controls using the SERIAL IN terminal of the display.

[DIGITAL LINK]:

Controls via the optional device that supports DIGITAL LINK output (ET-YFB100G, ET-YFB200G) and the DIGITAL LINK / LAN terminal.

[SLOT]:

Controls via the function board inserted to the SLOT of this unit.

■ [Network control]

Set when controlling with the unit's LAN terminal.

[On]:

Controls via LAN using the LAN terminal. The power indicator lights orange when the power is turned off with the remote control (standby).

[Off]:

Invalidates control with LAN terminal.

(In this case, the power consumption of Standby condition (when the power is turned off with the remote control) will be slightly reduced.)

Note

- When using the LAN control function which is described in "Using Network Function" (see page 91 – 109), set this function to [On].
- Even if the setting is set to [Off], the Web browser control screens that do not control this unit (display information [Status], detailed settings [Detailed set up] and password change [Change password]) operate.

■ [Auto display name]

Sets whether to change the display name automatically.

[On]:

Changes the display name automatically in accordance with the set point of the display ID.

[Off]:

The display name is not changed automatically.

■ [Display name]

The name of the Display that is shown on the network can be changed.

Note

- The name can be changed only when [Auto display name] is set to [Off].
- Display ID is not reset to default with [Network settings] - [Reset].

■ [LAN setup]

Detailed network settings for the LAN can be configured.

Select [LAN setup] with ▲ ▼ and press <ENTER>.

| LAN setup | |
|--------------|-------------------|
| Save | |
| DHCP | Off |
| IP address | 192.168. 0. 8 |
| Subnet mask | 255.255.255. 0 |
| Gateway | 192.168. 0. 1 |
| Command port | 1024 |
| EAP | None |
| User name | |
| Password | |
| MAC address | 12:34:56:78:9A:BC |

[DHCP], [IP address], [Subnet mask], [Gateway]

① Press ◀▶ to set [On] / [Off] of [DHCP].

When [Off] is selected, IP address and other settings can be set manually.

[DHCP]:

(DHCP client function)

[On]:

Obtains an IP address automatically when a DHCP server exists in the network the Display is going to be connected.

[Off]:

When a DHCP server does not exist in the network the Display is going to be connected, set [IP address], [Subnet mask] and [Gateway] manually.

[IP address]:

(IP address display and setting)

Enter an IP address when DHCP server is not used.

[Subnet mask]:

(Subnet mask display and setting)

Enter a Subnet mask when DHCP server is not used.

[Gateway]:

(Gateway address display and setting)

Enter a gateway address when DHCP server is not used.

Note

- When [DHCP] is set to [On], the IP address, etc. will be displayed in grey.

Entering numbers

| IP address |
|-----------------|
| 192.168.000.008 |

1. Select the address and press <ENTER>.
2. Select digits with ◀▶.
3. Change numbers with ▲ ▼.
4. Press <ENTER>.

You can cancel the change by pressing <RETURN>.

② Select [Save] and press <ENTER>.

Save the current network Setup.

Note

- To use a DHCP server, make sure the DHCP server is started.
- Contact your network administrator for details on [IP address], [Subnet mask] and [Gateway].
- Shipping condition

[DHCP]: Off

[IP address]: 192.168.0.8

[Subnet mask]: 255.255.255.0

[Gateway]: 192.168.0.1

[Command port]

Set the port number used for command control.

Select [Command port] and press <ENTER> to set the number.

- The available setting range is 1024 – 65535.
- Entering numbers (see page 78)

Note

- When the PJLink protocol is used, the port setting is not necessary.

[EAP]

Select the EAP that has been set for the RADIUS server. If the EAP has not been set, select [None].

The types of EAPs that can be set are as follows.

[PEAP(MS-CHAPv2)], [PEAP(GTC)], [EAP-TTLS(MD5)], [EAP-TTLS(MS-CHAPv2)], [EAP-FAST(MS-CHAPv2)], [EAP-FAST(GTC)], [EAP-TLS]

[User name]

Enter the user name for authentication with one-byte alphanumeric characters (excluding space). (Up to 64 characters)

This can be set only when [EAP] is set to items other than [None] or [EAP-TLS].

[Password]

Enter the password for authentication with one-byte alphanumeric characters. (Up to 64 characters)

This can be set only when [EAP] is set to items other than [None] or [EAP-TLS].

Note

- For 98 and 86 inch models, [EAP], [User name] and [Password] are displayed only when the main software version is 4.0000 or later.
- When EAP is used, this unit needs to be configured according to the settings of the RADIUS server. For the settings of the RADIUS server, consult with the network administrator.
- When [EAP] is set to [EAP-TLS], set [Date and time] (see page 76) and register the certificate on the WEB browser control. (see page 103)

[MAC address]

Displays the MAC address of this unit.

■ [Network status]

Checks the current Network settings status.

| Network status | |
|----------------|-------------------|
| DHCP | Off |
| IP address | 192.168.0.8 |
| Subnet mask | 255.255.255.0 |
| Gateway | 192.168.0.1 |
| EAP | None |
| MAC address | 12:34:56:78:9A:BC |

Note

- For 98 and 86 inch models, [EAP] is set only when the main software version is 4.0000 or later.

■ [DIGITAL LINK mode]

Switches communication method of DIGITAL LINK terminal.

[Auto]:

Communication method is selected automatically.

HDMI, LAN, serial communication are possible.

Ethernet connection is possible.

[DIGITAL LINK]:

HDMI, LAN, serial communication are possible via a twisted pair cable transmitter.

[Ethernet]:

LAN communication is possible via the LAN terminal of the display.

[Long reach]:

Communication method is fixed to Long reach.

Modes allowing communication

✓ : Valid

— : Invalid

| Settings | | Communication validity | | | |
|--------------|------------------|------------------------|-------|----------|---------|
| | | Picture transmission | | Ethernet | RS-232C |
| | | 100 m | 150 m | | |
| Auto | For DIGITAL LINK | ✓ | — | ✓ | ✓ |
| | For Long reach | — | ✓ | ✓ | ✓ |
| | For Ethernet | — | — | ✓ | — |
| DIGITAL LINK | | ✓ | — | ✓ | ✓ |
| Long reach | | — | ✓ | ✓ | ✓ |
| Ethernet | | — | — | ✓ | — |

Note

- When connected with the [Long reach] communication method, the maximum transmission distance is 150 m. In this case, this unit can receive the signals of up to 1080/60p (148.5 MHz).
- If the communication method of the twisted pair cable transmitter is set to [Long reach], set [DIGITAL LINK mode] to [Auto]. Then, connection is enabled with the [Long reach] communication method.

When connecting with the separately sold DIGITAL LINK Switcher (ET-YFB200G) with the [Long reach] communication method, set [DIGITAL LINK mode] to [Long reach].

- Even if [DIGITAL LINK mode] is set to [Long reach], when the twisted pair cable transmitter does not support the communication method of [Long reach], it will not be connected properly.

■ [DIGITAL LINK(Ethernet control)]

Enables or disables the Ethernet connection via the DIGITAL LINK terminal.

Note

- When this setting is changed, the communication via the LAN terminal is temporarily disconnected due to setting switching. Do not change the setting during LAN communication.
- Video and audio from the DIGITAL LINK terminal are not affected.

■ [DIGITAL LINK status]

Display the DIGITAL LINK connection environment. Select [DIGITAL LINK status] with ▲ ▼ and press <ENTER>.

| DIGITAL LINK status | |
|---------------------|---------|
| LINK status | No link |
| HDMI status | No HDMI |
| Signal quality | |
| Min | -XX dB |
| Max | -YY dB |

[LINK status]:

1 of the followings will be displayed.

[No link]:

No LAN connection, etc.

[DIGITAL LINK]:

Connected to the DIGITAL LINK device by LAN.

[Long reach]:

Communication method is set to [Long reach] and is connected to the DIGITAL LINK device by LAN.

[Ethernet]:

The PC is connected to the DIGITAL LINK / LAN terminal of this product and is LAN connected.

[HDMI status]:

Displays the connection status of the HDMI format.

1 of the followings will be displayed.

[No HDMI]:

DIGITAL LINK not connected

[HDMI on]:

DIGITAL LINK connected

[HDCP on]:

HDCP supported on DIGITAL LINK

[Signal quality]:

It is the quantified minimum and maximum numbers of errors that have occurred. The display colours are red, yellow, or green, depending on the number.

| Signal quality | Display Colours | Reception Status |
|----------------|-----------------|------------------|
| -12dB or below | Green | Good |
| -11 to -8dB | Yellow | Bad |
| -7dB or above | Red | Terrible |

- The number is represented by yellow or red if the LAN cable is disconnected or the cable is not shielded.
- This signal quality shows figures between the twisted pair cable transmitter that is connected and the display.

■ [DIGITAL LINK menu]

Displays the setting menu of Digital Interface Box.

Select [DIGITAL LINK menu] with ▲ ▼ and press <ENTER>.

Note

- This function can only be selected when the Panasonic device that supports DIGITAL LINK output (ET-YFB100G, ET-YFB200G) is connected to a DIGITAL LINK / LAN terminal and its power is on.
- For details, refer to the manuals of the devices that support DIGITAL LINK output.

■ [AMX D. D.]

Set whether to allow the Display to be detected by AMX Device Discovery.

[Off]:

Disables detection by AMX Device Discovery.

[On]:

Enables detection by AMX Device Discovery.

- For more details, visit the following web site.
<http://www.amx.com/>

■ [Crestron Connected]

When this function is set to [On], the Display can be monitored or controlled via the network using equipment and application software of Crestron Electronics, Inc.

This Display supports the following application software from Crestron Electronics, Inc.

- RoomView Express
- Crestron Fusion

Crestron Connected is a function to connect to a system developed by Crestron Electronics, Inc. which manages and controls multiple system devices connected to the network.

- For details of Crestron Connected, refer to the Crestron Electronics, Inc. web site (Provided only in English).
<http://www.crestron.com/>

For the download of "RoomView Express", refer to the Crestron Electronics, Inc. web site (Provided only in English).

(<https://www.crestron.com/en-US/resources/get-roomview>)

■ [Extron XTP]

Set to [On] when connecting XTP Transmitter made by Extron to DIGITAL LINK terminal.

- For more details on Extron, visit the following web site.

<http://www.extron.com>

■ [USB memory network settings]

Sets whether to permit the network setting using the USB memory device. (see page 134)

[Permit]:

Permits USB memory network settings.

[Prohibit]:

Prohibits USB memory network settings.

Note

- This function is set to [Permit] as factory default.
- Once the network setting is done with USB memory device, this function is set to [Prohibit].

■ [LAN control protocol]

Select the LAN control protocol.

[Protocol 1]:

Control with the Panasonic Display sequence.

[Protocol 2]:

Control with the sequence that is compatible with Panasonic Projector.

Note

- For PJLink and WEB browser control, the operation is possible regardless of the setting.
- When operating the "Multi Monitoring & Control Software", select [Protocol 2].

■ [Reset]

You can reset the network setting to the factory default of the Display.

Select [Yes] with ◀▶ and press <ENTER>.

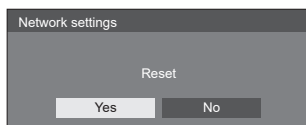

Note

- The settings for [NTP synchronization], NTP server and [Time zone] will be reset to the factory default.

USB media player settings

Set for "USB media player".

For details of the function, refer to "USB media player" (see page 111).

[USB media player settings] - submenu screen

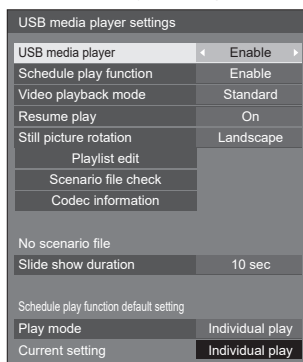

■ [USB media player]

Set to enable or disable the USB media player function.

■ [Schedule play function]

Enables/Disables the schedule playback function using "Content Management Software".

Note

- When [Schedule play function] is set to [Enable], if both the scenario file of the existing "USB media player" and the schedule file of this function are present, the [Schedule play function] operation takes priority.
- [USB media player] cannot be changed during the schedule playback mode.

■ [Video playback mode]

Sets the video playback mode.

If image disturbance occurs at the switching timing of motion picture files during playback in [Standard] mode, switch to [Adjust] mode.

[Standard]: Plays without a black image at the joint between video files.

[Adjust]: Plays with a black image (approx. 2 seconds) inserted at the joint between video files.

Note

- When using the Multi Media Player, a black screen is displayed for a certain period of time at the switching timing of motion picture files regardless of the [Video playback mode] settings.
- The display may be disturbed at the switching timing of files during playback in [Standard] mode.
- When the schedule playback is proceeding using "Content Management Software", [Video playback mode] can be switched both in single mode and multi mode.

■ [Resume play]

Set resume play off/on.

■ [Still picture rotation]

Sets the display method of still pictures by USB input.

[Landscape]:

Displays still pictures horizontally.

[Portrait]:

Displays still pictures vertically.

[Exif information]:

The display rotates according to the file information.

When the unit is installed in the portrait setting by setting [Display orientation] to [Portrait] or [Auto], the original screen is displayed being rotated clockwise by 90 degrees. (see page 86)

Note

- [Exif information] performs the rotation operation only in the JPEG format to which Exif information is added. If Exif information includes reverse display specification, or Exif information is not detected in a file, the screen is displayed without being rotated.
- When [Portrait display] is [On], this menu will be greyed out and cannot be set. (see page 58)

■ [Playlist edit]

Creates / Edits the scenario file (scenario.dat).

For details of [Playlist edit], refer to "Playlist edit function" (see page 118).

Note

- When [Portrait display] is [On], this menu will be greyed out and cannot be set. (see page 58)

■ [Scenario file check]

Execute the contents check of the USB memory which is connected to the USB terminal. If any error is detected, the error code and file name will be displayed.

For details of the error codes, refer to "USB memory contents check". (see page 116)

Select [Scenario file check] with ▲ ▼ and press <ENTER>.

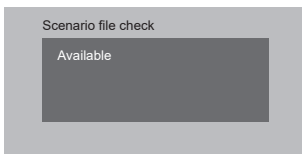

Note

- When the schedule playback is proceeding using "Content Management Software", [Scenario file check] is disabled.

■ [Codec information]

Displays the codec information of a motion picture/still picture file being played on the USB media player.

The file is analysed on execution, and the codec information is displayed after the completion of the analysis.

Note

- The file analysis takes time in proportion to the number of files in the USB memory device.
- A black screen appears during analysis because playback is stopped.
- Incompatible with the schedule play mode.

■ [Slide show duration]

Select the displaying duration for still images.

[10 sec] to [600 sec]

Note

- When the schedule playback is proceeding using "Content Management Software", [Slide show duration] is disabled.

■ Play mode

Specifies the playback mode operating with [Schedule play function]. To apply this setting to the schedule playback operation, restart this unit.

Also, if the playback mode is specified for the schedule data of "Content Management Software" during the schedule playback, it takes priority.

[Individual play]:

Plays in the individual playback mode.

Content is played only on one display.

[Synchronize play]:

Plays in the synchronized playback mode.

Content is played on multiple displays in synchronization.

Note approx. 5 seconds of preparation time are added in switching content to synchronize the playback timing.

Note

- The synchronized playback operates properly only when [Date and time] - [Synchronize display] is set to [On] and the time is synchronized.
- [Current setting] shows [Play mode] when the schedule playback is performed by this unit.

Memory viewer settings

Set for "Memory viewer".

For details of the function, refer to "Memory viewer" (see page 123).

[Memory viewer settings] - submenu screen

| Memory viewer settings | |
|------------------------------|-----------|
| Memory viewer | Enable |
| View | Thumbnail |
| Content select | Video |
| Sort type | File name |
| Sort order | Ascending |
| Play method | None |
| Picture duration | 10 sec |
| Auto display content info | On |
| Auto display operation guide | On |

■ [Memory viewer]

Enables/Disables "Memory viewer".

■ [View]

Sets the display format of the content in the USB memory device to the thumbnail display or the list display.

■ [Content select]

Sets the type of content to display.

[All]:

Displays all the files including picture, video and music files.

[Picture / Video]:

Displays picture files and video files.

[Picture / Music]:

Displays picture files and music files.

[Video / Music]:

Displays video files and music files.

[Picture]:

Displays picture files only.

[Video]:

Displays video files only.

[Music]:

Displays music files only.

■ [Sort type]

Sets the order of content in combination with [Sort order].

■ [Sort order]

Sets the order of content in combination with [Sort type].

■ [Play method]

Sets the playback method of content.

[None]:

Automatically returns to the content display screen when the playback of the selected file has finished.

[Single]:

Plays the selected file repeatedly.

[All]:

Plays the content displayed on the content display screen repeatedly in displayed order.

[Random]:

Plays the content displayed on the content display screen at random.

[Select]:

Plays the selected files in the sorting order shown on the content display screen.

[Program]:

Plays the selected file in selected order.

■ [Picture duration]

Sets the display time of still picture files.

10 sec to 600 sec

■ [Auto display content info]

When this is set to [On], the content information is automatically displayed at the beginning of the content playback, and the information is automatically erased after a certain period of time.

■ [Auto display operation guide]

When this is set to [On], the operation guide is automatically displayed at the beginning of the content playback, and the information is automatically erased after a certain period of time.

The playback control (see page 125) is performed only while the operation guide is being displayed. If it is not displayed, the unit shows the operation guide without performing the playback control.

When this is set to [Off], the operation guide is not displayed at the beginning of the content playback. The playback control is performed regardless of Show/Hide of the operation guide.

Note

- When [Play method] is set to [Single], playback information and operation guide are automatically displayed only at the beginning of the first playback of content.
- When [Play method] is [Select] or [Program], up to 99 files can be selected.
- This menu will be greyed out and cannot be set while content is being played.

Screen Transfer settings

[Screen Transfer settings] - submenu screen

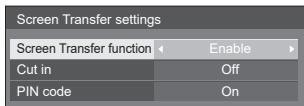

■ [Screen Transfer function]

Set the function to display images using Panasonic's dedicated application "Screen Transfer" to enable or disable.

■ [Cut in]

Sets whether to allow video interruption by another user while displaying a video using "Screen Transfer".

[Off]:

Disables video interruption.

[On]:

Enables video interruption.

■ [PIN code]

Sets whether to require the input of PIN code when connecting to this unit using "Screen Transfer".

[Off]:

Does not require the input of PIN code.

[On]:

Requires the input of PIN code.

Note

- For 98 and 86 inch models, [Screen Transfer settings] is displayed only when the main software version is 4.0000 or later.

Function button settings

Assigns specific functions to the numeric buttons (<1> to <6>). The buttons can be used as shortcut keys by assigning frequently used operations.

1 Switch [Function group] with ◀▶.

[Function button settings] - submenu screen

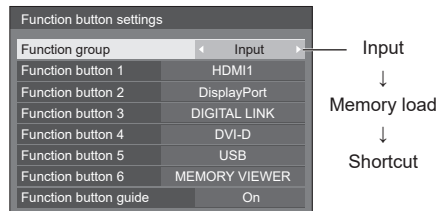

2 Select the numeric button with ▲▼ and set the function to assign with ▶.

Functions assignable to the numeric buttons

[Input] (Direct input select)

Input can be selected with single-touch operation.

[HDMI1] / [HDMI2] / [DisplayPort] / [DIGITAL LINK] / [DVI-D] / [SLOT] / [PC] / [Screen Transfer] / [USB] / [MEMORY VIEWER]

Note

- For 98 and 86 inch models, [Screen Transfer] is displayed only when the main software version is 4.0000 or later.

[Memory load]

Memory can be loaded with single-touch operation. Refer to "Memory load". (see page 53)

[MEMORY1] to [MEMORY6]

- [MEMORY1] to [MEMORY6] load functions are already assigned to <1> to <6> respectively. These settings cannot be changed.

[Shortcut]

[Signal], [Screensaver], [Set up timer], [Power management settings], [Network settings], [Multi display settings], [Portrait settings]

- Pressing the numeric button displays the menu screen. Pressing the button again exits the menu screen.

[AV mute]

- Pressing the numeric button mutes the audio and pictures.

To cancel, press any button on the remote control except the <Standby (ON/OFF) button>.

[Digital zoom]

- Switches to [Digital zoom] mode by pressing numeric buttons. (see page 42)

[Multi display switching]

- Pressing the numeric button will enter the multi display mode (multi input display, multi screen display). (see page 55)

[Display ID / Display name]

- Pressing the numeric button enlarges [Display ID] and [Display name].

[HDMI-CEC operation]

- Press the numeric buttons to display the operation screen of the HDMI-CEC compatible device.

[Playlist edit]

- Pressing the numeric button displays [Playlist edit] screen. (see page 118)

Shipping condition

The following functions are assigned to the numeric buttons as factory default.

98-inch model 86-inch model

| | [Input] | [Memory load] | [Shortcut] |
|---|---------------|---------------|---------------------------|
| 1 | HDMI1 | MEMORY1 | [Signal] |
| 2 | DisplayPort | MEMORY2 | [Set up timer] |
| 3 | DIGITAL LINK | MEMORY3 | [Network settings] |
| 4 | DVI-D | MEMORY4 | [Multi display switching] |
| 5 | USB | MEMORY5 | [AV mute] |
| 6 | MEMORY VIEWER | MEMORY6 | [HDMI-CEC operation] |

75-inch model 65-inch model 55-inch model

49-inch model

| | [Input] | [Memory load] | [Shortcut] |
|---|-----------------|---------------|----------------------|
| 1 | HDMI1 | MEMORY1 | [Signal] |
| 2 | DisplayPort | MEMORY2 | [Set up timer] |
| 3 | DIGITAL LINK | MEMORY3 | [Network settings] |
| 4 | Screen Transfer | MEMORY4 | [Digital zoom] |
| 5 | USB | MEMORY5 | [AV mute] |
| 6 | MEMORY VIEWER | MEMORY6 | [HDMI-CEC operation] |

■ [Function button guide]

Sets the function display when numeric buttons are pressed. Set this for each function group.

[On]:

Displays the function list for the numeric buttons.

[Off]:

Does not display the function list. Operation starts when numeric buttons are pressed.

Note

- When <FUNCTION> is pressed, [Function button guide] will be displayed regardless of the [On] / [Off] settings.

■ To use shortcut (numeric buttons)

1 Press <FUNCTION> or <1> – <6>.

[Function button guide] will be displayed.

[Function button guide]: When [Off] is set, pressing the numeric button starts operation.

Example: Input

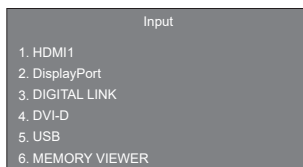

2 Press <FUNCTION> to switch function group.

Example: Memory load



3 Press <1> – <6>.

The function for the pressed button starts to operate.

Example: When <2> is pressed.

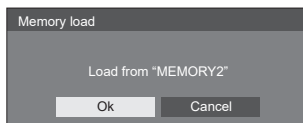

OSD settings

Makes various settings for the on-screen menus.

■ [Menu position]

Sets the display position of the on-screen menu.

Each time ◀ or ▶ is pressed, the display position of the on-screen menu changes.

Display example:

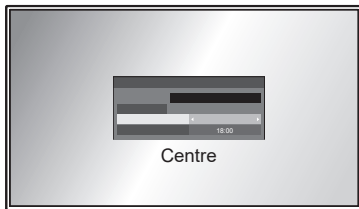
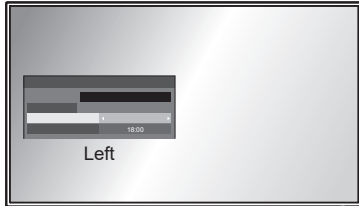

■ [Menu display duration]

Sets the display duration time for the on-screen menu.

[5 sec] to [180 sec]

■ [Onscreen display]

Set to display / hide the following Onscreen display.

- Power on display
- Input signal switch display
- No signal display
- No external media display (at USB input)
- MUTE display after displaying the menu screen
- Off timer remaining time display when 3 minutes remaining
- Display when responding to commands from external control

[On]:

Displays the Onscreen display.

[Off]:

Hides the Onscreen display.

■ [OSD transparency]

Sets the transparency rate of the on-screen display background.

0 to 100

■ [OSD memory]

Sets whether or not to hold the cursor position on the menu screen.

[Off]:

The cursor position is not held.

[On]:

The cursor position is held.

Note

- Even if it is set to [On], if the power of the main unit is turned off, the cursor position is not held.
- For 98/86/65/55/49 inch models, this setting is displayed only when the main software version is 4.0000 or later.

Display orientation

Sets the on-screen display orientation in the portrait setting.

[Landscape]:

On-screen display angle is for horizontal installation.

[Portrait]:

The on-screen display rotates clockwise by 90 degrees for easy view in the portrait setting.

[Auto]:

Detects the installation orientation of the display, and sets the display orientation automatically.

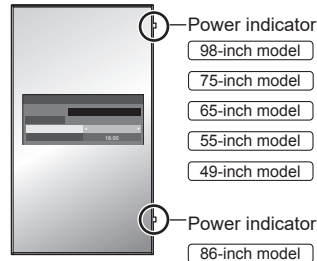

Note

- In the portrait setting, the power indicator shall come to the right side.
- Depending on the installation environment, [Auto] may not work normally. In this case, set the mode manually.

Image rotation

Sets the picture rotation in the portrait setting.

[Off]:

Pictures are not rotated.

[180 degrees]:

Pictures are rotated 180 degrees.

Note

- For the 98/86-inch model with the main software version of less than 3.0000, when the unit is installed in the landscape setting by setting [Display orientation] to [Landscape] or [Auto], picture rotation does not operate.

Setting [Position] when [Image rotation] is set to [180 degrees]

When [Image rotation] is set to [180 degrees], the adjustment direction becomes opposite of that in [Off] state. (see page 45)

Note these points for adjustment.

Options

This menu displays the information of this unit, and restores data to the factory default state.

[Options] - submenu screen

| |
|---------------------|
| Display information |
| Software licenses |
| Cloning password |
| USB data cloning |
| LAN data cloning |
| Output log data |
| Shipping |

■ [Display information]

Displays the serial number and software version of this unit.

■ [Software licenses]

Displays the software license.

■ [Cloning password]

Sets the password for the cloning function.

For more detail of the settings, see "Changing the cloning password". (see page 133)

Note

- The initial password in the factory default state is [AAAA].
- Change the password periodically, and set one which is difficult to guess.
- For initialization method for the cloning password, consult the dealer where you purchased the product.

■ [USB data cloning], [LAN data cloning]

Copies the data of a single display to multiple displays by using the USB memory device or via LAN. For more detail of the settings, see "Using data cloning". (see page 130)

■ [Output log data]

Saves a log for servicing to the USB memory device.

■ [Shipping]

Restores the data of this unit to the factory default state. For more detail of the settings, see "Shipping condition". (see page 141)

Control settings

Sets each item of the function which enables to control multiple displays at the same time, or individually.

[Control settings] - submenu screen

| Control settings | |
|--------------------------|-----|
| Display ID | |
| Controller ID function | Off |
| Serial ID function | Off |
| Serial response (Normal) | On |
| Serial response(ID all) | Off |

■ [Display ID]

Set ID number when controlling the Display with [Controller ID function] and [Serial ID function].

0 to 100 (Standard value: 0)

■ [Controller ID function]

Enables/disables the [Controller ID function].

[Off]:

Disables the [Controller ID function]. (Can be operated as normal remote control.)

[On]:

Enables the [Controller ID function]. Effective on switching to [On].

Note

- To use the [Controller ID function], setting ID numbers both for the remote control and for the display unit is required.
For ID number setting for the remote control, see page 136.
- About how to reset the settings to defaults, refer to "Initialization". (see page 142)

■ [Serial ID function]

Set to control external control with the PC connected to SERIAL terminal according to the Display's ID number.

[Off]:

Disables external control by the ID.

[On]:

Enables the external control by the ID.

■ [Serial response (Normal)]

Sets whether to send the response command to normal commands without ID.

[Off]:

Does not respond. (Including the inquiry command)

[On]:

Responds.

■ [Serial response(ID all)]

Set whether to respond to the command or not, when serial command of ID number "0" is received.

[Off]:

Does not respond.

[On]:

Responds.

Information timing

Set up the informing manner for no signal or temperature rising.

RS-232C controls:

Warning or error message sent from the display automatically.

LAN controls:

Acquire the warning or error message from the display.

[Information timing] - submenu screen

| Information timing | |
|--------------------------|-------|
| No signal warning | On |
| No signal warning timing | 5min |
| No signal error | On |
| No signal error timing | 10min |
| Temperature warning | On |

■ [No signal warning]

When set to [On], the display sends out the no signal warning.

■ [No signal warning timing]

Set up the detecting time for no signal warning.
(Range: 01 – 60, Interval: 1 minute)

■ [No signal error]

When set to [On], the display sends out the no signal error.

■ [No signal error timing]

Set up the detecting time for no signal error.
(Range: 01 – 90, Interval: 1 minute)

- The warning of [No signal warning] and the error of [No signal error] are not sent when the no signal state is detected through any of the following functions:

[No signal power off], [HDMI1 power management], [HDMI2 power management], [DisplayPort power management], [DIGITAL LINK power management], [DVI-D power management], [PC power management] (see page 69)

Setting Example:

- If there is no signal when [PC IN] is input, [PC power management] is activated first and the Display enters the standby mode.

[No signal warning timing]: 5 minutes

[No signal error timing]: 10 minutes

[PC power management]: [On] (60 seconds)

Note

- The [No signal error timing] cannot be set shorter than [No signal warning timing].
- Even when a USB memory is connected, if there is no playable file, the unit determines no signal is present.

■ [Temperature warning]

When set to [On], the display sends out the warning message.

SLOT settings

Set for SLOT.

This menu is displayed only when a function board is inserted into the SLOT.

[SLOT settings] - submenu screen

| SLOT settings | |
|-------------------------|-----|
| SLOT information | On |
| SLOT power link | Off |
| SLOT standby | On |
| SLOT power on | On |
| SLOT forced termination | |

■ [SLOT information]

Displays the information of the function board inserted to the SLOT.

■ [SLOT power link]

Links the power operation of the SLOT with the power operation of this unit.

[Off]:

Does not link.

[On]:

The power of the unit is turned off when the power of the inserted function board is turned off during SLOT input or enters the power save mode. After that, when the power of the function board is turned on or returns from the power save mode, the power of the unit is turned on.

Note

- When [HDMI-CEC control] is set to [Enable], this menu will be greyed out and cannot be set. (see page 72)

■ [SLOT standby]

Sets the power supply status for the SLOT when the unit is in standby mode.

[Off]:

The power is not supplied to the SLOT when the power is turned off by the remote control, etc.

[On]:

The power is supplied to the SLOT when the power is turned off by the remote control, etc.

Note

- When [SLOT standby] is set to [On], the power indicator in standby mode lights orange (red/green).
- When [HDMI-CEC control] is set to [Enable], this menu will be greyed out and cannot be set. (see page 72)

■ [SLOT power on]

Starts up the power of the SLOT.

■ [SLOT forced termination]

Forcibly turns off the power of the SLOT. Use this only when the power cannot be turned off manually due to the problem of the operating system, etc.

Maximum VOL function

Enables/Disables [Maximum VOL function].

[Off]:

The sound volume level can be set up to 100 (maximum).

[On]:

The volume cannot be set to the level higher than the level set for [Maximum VOL level].

Maximum VOL level

Sets the sound volume when [Maximum VOL function] is enabled.

Note

- Outputs with the set volume when [Maximum VOL level] in [On] state is selected on the menu.
- When the [Maximum VOL function] is switched from [Off] to [On], if the [Maximum VOL level] is set lower than the [Initial VOL level], the [Initial VOL level] automatically becomes the same as the [Maximum VOL level].

Button lock

Limits operation of the buttons on the unit.

[Off]:

All the buttons on main unit can be used.

[On]:

All button operations except for the <Main Power On / Off button> are disabled.

[MENU & ENTER]:

Locks <MENU (Unit)> and <ENTER (Unit)> buttons.

■ To set [Button lock]

Set with the buttons on the unit.

[Off]:

- ① Press <+ (Unit)> for 4 times.
- ② Press <INPUT (Unit)> for 4 times.
- ③ Press <- (Unit)> for 4 times.
- ④ Press <ENTER (Unit)>.

[On]:

- ① Press <- (Unit)> for 4 times.
- ② Press <ENTER (Unit)> for 4 times.
- ③ Press <+ (Unit)> for 4 times.
- ④ Press <ENTER (Unit)>.

[MENU & ENTER]:

- ① Press <ENTER (Unit)> for 4 times.
- ② Press <+ (Unit)> for 4 times.
- ③ Press <INPUT (Unit)> for 4 times.
- ④ Press <ENTER (Unit)>.

Note

- About how to reset the settings to defaults, refer to "Initialization". (see page 142)

POWER button lock

Sets the lock setting for the display <Main Power On / Off button>.

[Off]:

<Main Power On / Off button> operation is enabled.

[On]:

<Main Power On / Off button> operation is disabled.

Controller user level

Limits operation of the buttons on the remote control.

[Off]:

You can use all of the buttons on the remote control.

[User1]:

You can only use <Standby (ON/OFF) button>, <INPUT>, <RECALL>, <MUTE>, <VOL +> and <VOL -> buttons on the remote control.

[User2]:

You can only use <Standby (ON/OFF) button> on the remote control.

[User3]:

Locks all the buttons on the remote control.

Note

- About how to reset the settings to defaults, refer to "Initialization". (see page 142)

DVI-D/SLOT select

Selects a terminal to use.

[DVI-D]:

Uses DVI-D IN terminal.

[SLOT]:

Uses SLOT.

USB select

Selects a USB port to use for the USB function.

[MP1]:

Uses MP1 as a function operation terminal.

[MP2]:

Uses MP2 as a function operation terminal.

Note

- Regardless of the setting, both terminals can be used for power supply. (see page 30)

Quick input change mode

Sets the mode to switch the input at high speed.

[Off]:

Switches the input in normal mode.

[On]:

Switches the input in high speed mode between the following inputs.

[HDMI1] / [HDMI2] / [DisplayPort] / [DVI-D] / [SLOT]

Note

- Switching at high speed is possible only when the types of signals are the same between inputs.
- When switching the input at high speed, as for the values of the position, size and image menu, images are once displayed with the setting values for the terminal before switching, and then images are displayed with the setting values for the terminal after switching.

Using Network Function

This unit has a network function and you can control the Display connected to the network using your computer.

Necessary environment for computers to be connected

First of all, confirm your computer whether it has a wired LAN.

Before connecting the Display to the computer, be sure to check the following settings.

Check 1: About LAN cable

- Connect the cable properly.
- Use LAN cable that is compatible with category 5e or above.

Check 2: Wired LAN settings

Computer with a built-in wired LAN function

- Switch on the wired LAN.

Computer without a built-in wired LAN function

- Check that your wired LAN adapter is recognized properly and it is switched on.
- Install the wired LAN adapter driver beforehand.

For details on how to install the driver, refer to the instructions accompanying the wired LAN adapter.

About Web Browser

Web Browser is necessary to use WEB control.

- Compatible OS:
Windows, Mac OS
- Compatible Web Browser:
Internet Explorer 11.0 (Windows)
Safari 8.0 / 9.0 / 10.0 / 11.0 (Mac OS)
Microsoft Edge

Example of network connection

Note

- To use the network function, set each item in [Network settings] and make sure to set [Network control] to [On].
(see page 77)
When it is set to [On], power indicator lights orange under the condition of power "Off" with remote control (stand-by state).
- The DIGITAL LINK / LAN terminal and the LAN terminal are connected inside this unit. When using both the DIGITAL LINK / LAN terminal and the LAN terminal, configure the system in such a way that they are not connected to the same network directly or via peripheral devices such as hub and twist pair cable transmitter.

LAN Terminal connection

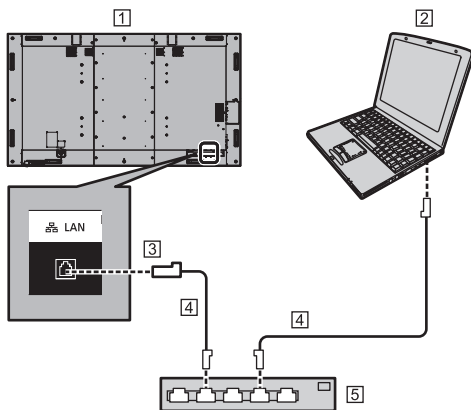

① Display (Back of the unit)

② PC

③ LAN terminal

④ LAN cable (commercially available)

⑤ Hub or broadband router

Note

- For LAN cable, use shielded cable, otherwise picture noise may be caused.
- Make sure the broadband router or hub supports 10BASE-T / 100BASE-TX.
- Touching the LAN Terminal with a statically charged hand (body) may cause damage to the device due to its discharge.
Do not touch the LAN Terminal or the metal part of the LAN cable.
- For instructions on connection, consult your network administrator.

■ DIGITAL LINK Terminal connection

A twisted pair cable transmitter, such as the Panasonic device that supports DIGITAL LINK output (ET-YFB100G, ET-YFB200G) uses twisted pair cables to transmit inputted video and audio signals, and these digital signals can be input to the Display via the DIGITAL LINK terminal.

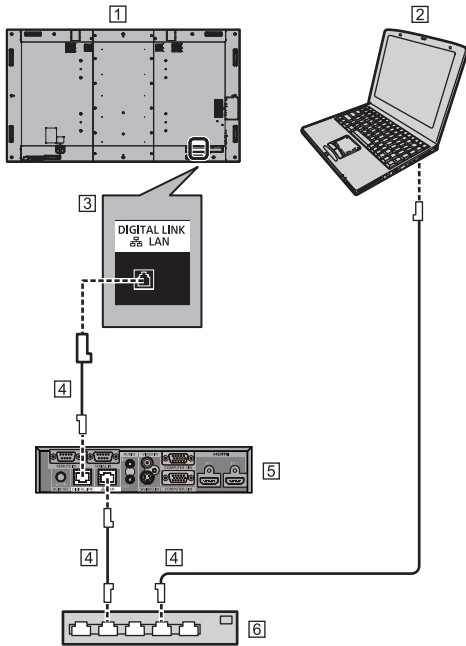

- 1 Display (Back of the unit)
- 2 PC
- 3 DIGITAL LINK/LAN terminal
- 4 LAN cable (commercially available)
- 5 Example: Panasonic ET-YFB100G
- 6 Hub or broadband router

Note

- When using a DIGITAL LINK connection, set each item in [Network settings]. (see page 77)

Precautions for use while connecting with a twisted pair cable transmitter

About installation / connection

- Ask a professional or the dealer to carry out the cable wiring work for DIGITAL LINK connections. Insufficient wiring work may cause the inability to apply the cable transmission characteristics and cropped or fuzzy images and sounds.
- The transmission distance between the twisted pair cable transmitter and the device is normally up to 100 meters. When the transmitter supports [Long reach] communication method, the transmittable distance is up to 150 m. Please note that if exceeding the limit, video or audio may be interrupted, or malfunction may be caused during LAN communication. Furthermore, when connecting using [Long reach] communication method, depending on the specification of the transmitters, transmittable video signals or the distance may be limited.
- The transmission distance between the twisted pair cable transmitter and the device is up to 100 meters. When transmitting 4K signal, the maximum is 50 meters.

Exceeding this distance can cause cropped images or sounds, as well as LAN communication errors.

- Do not use a hub between the twisted pair cable transmitter and the device.
- When connecting the Display using the twisted pair cable transmitter (receiver) of other manufacturer, do not use another twisted pair cable transmitter between the twisted pair cable transmitter of other manufacturer and this device. The images and sounds may be interrupted or become unstable.
- If possible, lay the cable extended and not coiled in order to minimize both external and internal noise.
- Lay out cables of the twist pair cable transmitter and this product away from other cables, especially from the power supply cable.
- When laying multiple cables, keep them together as close as possible running parallelly and not bundled.
- After laying the cable(s), check that the signal quality in [DIGITAL LINK status] is -12 dB or below.

About Twisted pair cables

- Between the twisted pair cable transmitter and the device, use a LAN cable that conforms to the following conditions.
 - It meets or exceeds CAT5e standards
 - It is a straight cable
 - It is a shielded cable (with a connector)
 - It is a solid cable
- When laying the cable(s), use an instrument such as a cable tester or cable analyser and check whether the cable characteristics are CAT5e or above. When using a relay connector along the path, also include this in the measurements.
- Do not pull cables hard. Also, avoid bending or folding them forcefully.

Other

- This device is compatible with Panasonic devices that support DIGITAL LINK output (ET-YFB100G, ET-YFB200G). For the twisted pair cable transmitter of other manufacturers, see the web site.
(https://panasonic.net/cns/prodisplays/solutions/technology/digital_link/compatible_equipment/)
- Panasonic has tested other manufacturers' devices according to our check items. This will not guarantee all the operations. For operation and performance defects caused by other manufacturers' devices, contact each manufacturer.

Command control

Network function of the unit can control the unit in the same way as serial control from a network.

Supported commands

Commands used in the serial control are supported. (see page 29)

Control Command via LAN

The communication differs whether [Setup] - [Network settings] - [LAN control protocol] is set to [Protocol 1] or [Protocol 2].

1. When [LAN control protocol] is set to [Protocol 1].

Communicates using the display-specific protocol.

■ When the WEB control administrator privileges password has been set (Protect mode)

Connection method

1 Obtain the display's IP address and the port number (Default is 1024), and request connection to the display.

The IP address and the port number can be obtained from the following menus.

- IP address:
[Setup] → [Network settings] → [LAN setup] or [Network status]
- Port number:
[Setup] → [Network settings] → [LAN setup]
- For more detail of the settings, see page 78.

2 The display responds.

Response data

| Data part | Space | Mode | Space | Random number part | Last terminal symbol |
|--|-------------|-------------|-------------|--------------------------------------|----------------------|
| [PDPCONTROL] (ASCII character string) | [] 0x20 | [1] 0x31 | [] 0x20 | [zzzzzzz] (ASCII code hex number) | (CR) 0x0d |
| 10 bytes | 1 byte | 1 byte | 1 byte | 8 bytes | 1 byte |

Mode: 1 = Protect mode

- 3 Hash the following data with the MD5 algorithm, and generate a 32-byte hash value.

[zzzzzzzzyyyyyy]

zzzzzzzz :

8-byte random number obtained in step 2

yyyyyy :

Password of the WEB control administrator privileges user

- Default user name and password are as follows:

User name: dispadmin

Password: @Panasonic

Command transmission method

Transmit in the following command format

Transmitted data

| Header | Control symbol | Data part | Control symbol | Last terminal symbol |
|---|----------------|--|----------------|----------------------|
| Hash value (see "Connection method") | (STX) 0x02 | Control command (ASCII character string) | (ETX) 0x03 | (CR) 0x0d |
| 32 bytes | 1 byte | Undefined | 1 byte | 1 byte |

Received data

| Control symbol | Data part | Control symbol | Last terminal symbol |
|----------------|--|----------------|----------------------|
| (STX) 0x02 | Control command (ASCII character string) | (ETX) 0x03 | (CR) 0x0d |
| 1 byte | Undefined | 1 byte | 1 byte |

Error response

| Error message | Last terminal symbol |
|--|----------------------|
| "ERR1" : Undefined control command | (CR) 0x0d |
| "ERR2" : Out of parameter range | |
| "ERR3" : Busy status or reception invalid period | |
| "ERR4" : Timeout or reception invalid period | |
| "ERR5" : Wrong data length | |
| "PDPCONTROL ERRA" : Mismatching of password | |
| 4 bytes or 15 bytes | 1 byte |

■ When the WEB control administrator privileges password has not been set (Non-protect mode)

Connection method

- 1 Obtain the display's IP address and the port number (Default is 1024), and request connection to the display.

The IP address and the port number can be obtained from the following menus.

- IP address:
[Setup] → [Network settings] → [LAN setup] or [Network status]
- Port number:
[Setup] → [Network settings] → [LAN setup]
- For more detail of the settings, see page 78.

- 2 The display responds.

Response data

| Data part | Space | Mode | Last terminal symbol |
|--|-------------|-------------|----------------------|
| [PDPCONTROL] (ASCII character string) | [] 0x20 | [0] 0x30 | (CR) 0x0d |
| 10 bytes | 1 byte | 1 byte | 1 byte |

Mode:0 = Non-protect mode

Command transmission method

Transmit in the following command format

Transmitted data

| Control symbol | Data part | Control symbol | Last terminal symbol |
|----------------|---|----------------|----------------------|
| (STX) 0x02 | Control command (ASCII character string) | (ETX) 0x03 | (CR) 0x0d |
| 1 byte | Undefined | 1 byte | 1 byte |

Received data

| Control symbol | Data part | Control symbol | Last terminal symbol |
|----------------|---|----------------|----------------------|
| (STX) 0x02 | Control command (ASCII character string) | (ETX) 0x03 | (CR) 0x0d |
| 1 byte | Undefined | 1 byte | 1 byte |

Error response

| Error message | Last terminal symbol |
|--|----------------------|
| “ERR1” : Undefined control command | (CR) 0x0d |
| “ERR2” : Out of parameter range | |
| “ERR3” : Busy status or reception invalid period | |
| “ERR4” : Timeout or reception invalid period | |
| “ERR5” : Wrong data length | |
| 4 bytes | 1 byte |

2. When [LAN control protocol] is set to [Protocol 2].

Communicates with the same protocol as that of a Panasonic projector

■ When the WEB control administrator privileges password has been set (Protect mode)

Connection method

1 Obtain the display's IP address and the port number (Default is 1024), and request connection to the display.

The IP address and the port number can be obtained from the following menus.

- IP address:
[Setup] → [Network settings] → [LAN setup] or [Network status]
- Port number:
[Setup] → [Network settings] → [LAN setup]
- For more detail of the settings, see page 78.

2 The display responds.

Response data

| Data part | Space | Mode | Space | Random number part | Last terminal symbol |
|---|-------------|-------------|-------------|---------------------------------------|----------------------|
| [NTCONTROL] (ASCII character string) | [] 0x20 | [1] 0x31 | [] 0x20 | [zzzzzzzz] (ASCII code hex number) | (CR) 0x0d |
| 9 bytes | 1 byte | 1 byte | 1 byte | 8 bytes | 1 byte |

Mode: 1 = Protect mode

3 Hash the following data with the MD5 algorithm, and generate a 32-byte hash value.

[xxxxxx:yyyyy:zzzzzzzz]

xxxxxx :

WEB control administrator privileges user name

yyyyy :

Above administrator privileges user password

- Default user name and password are as follows:

User name: dispadmin

Password: @Panasonic

zzzzzzzz :

8-byte random number obtained in step 2

Command transmission method

Transmit in the following command format

Transmitted data

| Header | | | Data part | Last terminal symbol |
|---|-------------|-------------|--|----------------------|
| Hash value (see "Connection method") | '0' 0x30 | '0' 0x30 | Control command (ASCII character string) | (CR) 0x0d |
| 32 bytes | 1 byte | 1 byte | Undefined | 1 byte |

Received data

| Header | | Data part | Last terminal symbol |
|-------------|-------------|--|----------------------|
| '0' 0x30 | '0' 0x30 | Control command (ASCII character string) | (CR) 0x0d |
| 1 byte | 1 byte | Undefined | 1 byte |

Error response

| Error message | Last terminal symbol |
|--|----------------------|
| "ERR1" : Undefined control command | (CR) 0x0d |
| "ERR2" : Out of parameter range | |
| "ERR3" : Busy status or reception invalid period | |
| "ERR4" : Timeout or reception invalid period | |
| "ERR5" : Wrong data length | |
| "ERRA" : Mismatching of password | |
| 4 bytes | 1 byte |

■ When the WEB control administrator privileges password has not been set (Non-protect mode)

Connection method

1 Obtain the display's IP address and the port number (Default is 1024), and request connection to the display.

The IP address and the port number can be obtained from the following menus.

- IP address:
[Setup] → [Network settings] → [LAN setup] or [Network status]
- Port number:
[Setup] → [Network settings] → [LAN setup]
- For more detail of the settings, see page 78.

2 The display responds.

Response data

| Data part | Space | Mode | Last terminal symbol |
|---|-------------|-------------|----------------------|
| [NTCONTROL] (ASCII character string) | [] 0x20 | [0] 0x30 | (CR) 0x0d |
| 9 bytes | 1 byte | 1 byte | 1 byte |

Mode:0 = Non-protect mode

Command transmission method

Transmit in the following command format

Transmitted data

| Header | | Data part | Last terminal symbol |
|-------------|-------------|--|----------------------|
| '0' 0x30 | '0' 0x30 | Control command (ASCII character string) | (CR) 0x0d |
| 1 byte | 1 byte | Undefined | 1 byte |

Received data

| Header | | Data part | Last terminal symbol |
|-------------|-------------|--|----------------------|
| '0' 0x30 | '0' 0x30 | Control command (ASCII character string) | (CR) 0x0d |
| 1 byte | 1 byte | Undefined | 1 byte |

| Error message | Last terminal symbol |
|--|----------------------|
| “ERR1” : Undefined control command | (CR) 0x0d |
| “ERR2” : Out of parameter range | |
| “ERR3” : Busy status or reception invalid period | |
| “ERR4” : Timeout or reception invalid period | |
| “ERR5” : Wrong data length | |
| 4 bytes | 1 byte |

Note

- With some of the commands, a part of character string of the transmitted data may not be included in the received data.
- Consult your local Panasonic dealer for detail instructions on command usage.
For more details, visit the following web site.
<https://panasonic.net/cns/prodisplays/>

PJLink protocol

The unit’s Network function is compatible with PJLink Class 1. The following operations can be performed from a computer when PJLink protocol is used.

- Setting the Display
- Querying the Display status

Supported commands

The commands to control the unit with PJLink protocol are as follows.

| Command | Control |
|---------|--|
| POWR | Power control 0: Standby 1: Power On |
| POWR? | Power status query 0: Standby 1: Power On |
| INPT | Input switch 11: PC IN input 31: HDMI 1 input (HDMI1) 32: HDMI 2 input (HDMI2) 33: DisplayPort IN input (DisplayPort) 34: DIGITAL LINK input (DIGITAL LINK) 35: DVI-D IN input (DVI-D) 36: SLOT input (SLOT) 41: USB input (USB) 42: MEMORY VIEWER input (MEMORY VIEWER) 51: Screen Transfer input*1 (Screen Transfer) |
| INPT? | Input switch query 11: PC IN input 31: HDMI 1 input (HDMI1) 32: HDMI 2 input (HDMI2) 33: DisplayPort IN input (DisplayPort) 34: DIGITAL LINK input (DIGITAL LINK) 35: DVI-D IN input (DVI-D) 36: SLOT input (SLOT) 41: USB input (USB) 42: MEMORY VIEWER input (MEMORY VIEWER) 51: Screen Transfer input*1 (Screen Transfer) |

| Command | Control |
|---------|--|
| AVMT | Shutter control 10: Picture On (picture mute deactivated) 11: Picture Off (picture on mute) 20: Audio On (audio mute deactivated) 21: Audio Off (audio on mute) 30: Shutter mode Off (picture and audio mute deactivated) 31: Shutter mode On (picture and audio on mute) |
| AVMT? | Shutter control query 11: Picture Off (picture on mute) 21: Audio Off (audio on mute) 30: Shutter mode Off (picture and audio mute deactivated) 31: Shutter mode On (picture and audio on mute) |
| ERST? | Error status query First byte: 0 Second byte: 0 Third byte: 0 Fourth byte: 0 Fifth byte: 0 Sixth byte: Other error. 0 or 2. <ul style="list-style-type: none"> • Meaning of 0, 2. 0: Error is not detected, 2: Error |
| LAMP? | Lamp status query Not supported |
| INST? | Input switch list query 11: PC IN input 31: HDMI 1 input (HDMI1) 32: HDMI 2 input (HDMI2) 33: DisplayPort IN input (DisplayPort) 34: DIGITAL LINK input (DIGITAL LINK) 35: DVI-D IN input (DVI-D) 36: SLOT input (SLOT) 41: USB input (USB) 42: MEMORY VIEWER input (MEMORY VIEWER) 51: Screen Transfer input*1 (Screen Transfer) |
| NAME? | Display name query The name selected in [Display name] is returned. |
| INF1? | Manufacturer name query Returns "Panasonic". |

| Command | Control |
|---------|--|
| INF2? | Model name query Returns "98SQ1W". (Example: 98-inch SQ1W model) |
| INFO? | Other information query Returns version number. |
| CLSS? | Class information query Returns "1". |

*1: For 98 and 86 inch models, 51: Screen Transfer input is available only when the main software version is 4.0000 or later.

PJLink security authentication

The password used for PJLink is the same as the password set for the WEB control. (see page 101)

When using PJLink without security authorization, set use without the password for administrator privileges and the password for user privileges of Web browser control.

- Concerning the specification of PJLink, see the web site of Japan Business Machine and Information System Industries Association (JBMA) below:
<http://pjlink.jbma.or.jp/english/index.html>

Multi Monitoring & Control Software

This unit supports the early warning software "Multi Monitoring & Control Software" which monitors and controls devices (projectors or displays) connected to an intranet, and detects signs of abnormality of such devices that may arise in future.

As for the early warning function, the maximum number of devices that can be registered to monitor differs according to the type of license.

Up to 2 048 devices can be registered for free for a maximum of 90 days after the installation to the computer has completed.

- For more details, visit the following web site.
<https://panasonic.net/cns/prodisplays/>
- About early warning function, visit the following web site.
<https://panasonic.net/cns/prodisplays/pass/>

Video Wall Manager

This unit supports the "Video Wall Manager" software which adjusts multiple displays simultaneously or separately on one computer without rearranging cables.

- For more details, visit the following web site.
<https://panasonic.net/cns/prodisplays/>

Content Management Software

This unit supports "Content Management Software" to create schedule data on a PC required to play back still pictures and motion pictures. (Supports Ver.3.0 or later. For the caption display function, supports Ver.3.1 or later.)

- For more details, visit the following web site.

<https://panasonic.net/cns/prodisplays/>

Screen Transfer

This unit supports the software [Screen Transfer] that sends the PC screen to the display via wired LAN.

[Screen Transfer] can be downloaded from [Download] for the Web browser control. (see page 109)

- For more details, visit the following web site.

<https://panasonic.net/cns/prodisplays/>

Note

- For 98 and 86 inch models, [Screen Transfer] is available only when the main software version is 4.0000 or later.

Connecting with LAN

Note

- To use the network function, set each item in [Network settings] and be sure to set [Network control] to [On]. (see page 77)

Computer operation

- 1 Turn on the computer.
- 2 Make the network setting according to your system administrator.

When the Display settings are the default settings (see page 78), the computer can be used with the following network settings.

| | |
|-------------|---------------|
| IP address | 192.168.0.9 |
| Subnet mask | 255.255.255.0 |
| Gateway | 192.168.0.1 |

Using Web Browser Control

You can use a Web browser to control the unit and set up a network and password.

Before Using Web Browser Control

To use the Web browser control, the unit and computer set ups are required.

■ About Web Browser

Set each item in [Network settings] and be sure to set [Network control] to [On]. (see page 77)

Note

- Even if the setting is set to [Off], the Web browser control screens that do not control this unit (display information [Status], detailed settings [Detailed set up] and password change [Change password]) operate.

■ Computer Setup

Disable the proxy server settings and enable JavaScript.

- The setting procedure differs depending on the software version.

Please refer to description in HELP, etc. of the software.

(Windows)

Windows 10 is used as an example.

Disable proxy server settings

- 1 Display [Internet Properties] window.
Click [Start] → [Settings] → [Network & Internet] → [Ethernet] → [Network and Sharing Center] → [Internet Options].
- 2 Click the [Connections] tab and then [LAN Settings].
- 3 Deselect the [Use automatic configuration script] and [Use a proxy server for your LAN] boxes.
- 4 Click [OK].

Enable JavaScript

- 1 Display [Internet Properties] window.
Click [Start] → [Settings] → [Network & Internet] → [Ethernet] → [Network and Sharing Center] → [Internet Options].
- 2 Set the security level on the [Security] tab to [Default Level]. Alternatively enable [Active scripting] from the [Custom Level] button.

(Mac)

Disable proxy server settings

- 1 From the [Safari] menu, click [Preferences].
General screen is displayed.
- 2 From the [Advanced] tab, click the [Change Settings...] button next to [Proxies].
Click [Proxies] and set up a proxy server.
- 3 Deselect the [Web Proxy] and [Automatic Proxy Configuration] boxes.
- 4 Click [Apply Now].

Enable JavaScript

- 1 Display [Security] of Safari.
- 2 Select [Enable JavaScript] under [Web content].

Access from Web Browser

Access to the TOP screen of the Web browser control using a Web browser.

- 1 Start your Web browser.
- 2 Enter the IP address set with the [LAN setup] of the unit.

(see page 78)



- 3 Enter the user name and password when the Authentication screen is displayed.

When using the Web control function for the first time, changing the password is required. Proceed to step 4.

If you have already used the Web control function, proceed to step 7.

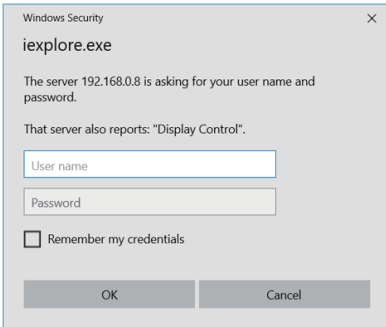

4 Click [OK].

Change Use name / Password page is displayed.

For [Administrator]

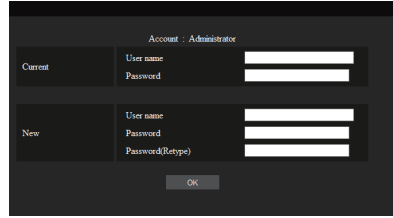

For [User]

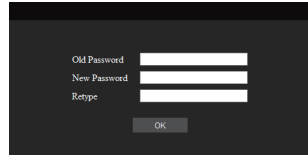

- 5 Enter the new user name and password, and then click [Change].

The screen of step 3 is displayed again.

- 6 Enter the new user name and password.

Enter the new user name and password set in step 5.

- 7 Click [OK].

Note

- The password used here is the same password used for command control and the PJLink security authentication.
- Default user name and password are as follows:
User name: dispuser (user rights)
 dispadmin (administrator rights)
Password: @Panasonic
Change password first.
- When [Reset] for [Network settings] of this unit is executed, the password change is also required after log-in. (see page 81)
- The password can be changed on the Password Setup screen after logging in (see page 107). The user name can be changed when connecting by logging in with administrator privileges.
- If a wrong user name/password is entered 3 times when you log in, the field will be locked for several minutes.
- When using [Detailed set up] (see page 103) or "Crestron Connected" (see page 108), log in with the administrator rights.
- Depending on the browser, displayed operations may change.
- Under no circumstances, Panasonic Corporation or its associated companies will ask customers their password directly.

Even if you are asked directly, please do not reveal your password.

■ Description of each section

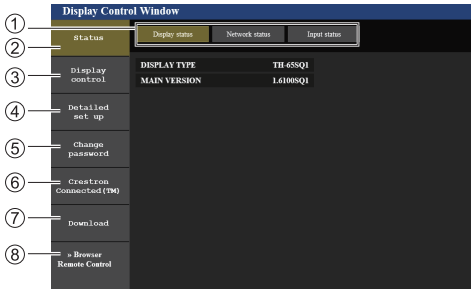

① Page tab

Click these to switch pages.

② [Status]

Click this item, and the status of the Display is displayed.

③ [Display control]

Click this item to display the Display control page.

④ [Detailed set up]

Click this item to display the advanced settings page.

⑤ [Change password]

⑥ [Crestron Connected]

Click this item to display the Crestron Connected operation page.

⑦ [Download]

Click this item to display the page to download the dedicated application, [Screen Transfer].

⑧ [Browser Remote Control]

Click this item to display the Browser Remote Control on the WEB browser, which is the same as the supplied remote control.

Note

- For 98 and 86 inch models, [Download] is displayed only when the main software version is 4.0000 or later.

■ Display status page

Displays the display status.

Click [Status] → [Display status].

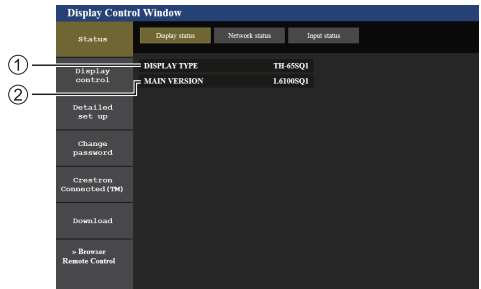

① Displays the type of Display.

② Displays the firmware version of the display.

■ Network status page

Displays the current configuration information of the network.

Click [Status] → [Network Status].

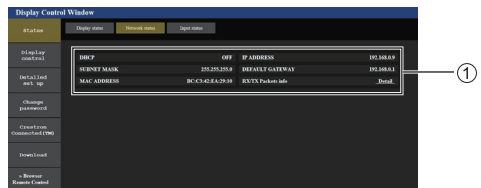

① Displays the configuration details of wired LAN.

■ Input information page

Displays the input information of this unit.

Click [Status] → [Input status].

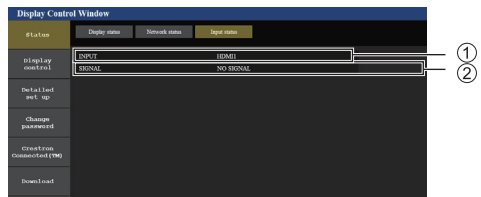

① Displays the information of the input terminal.

② Displays the information of the input signal.

Note

- If an input is other than USB input or MEMORY VIEWER input, the name of the input signal is displayed.
- In the case of USB input and MEMORY VIEWER input, the name of the file being played is displayed.
- [----] is displayed in standby mode.

■ Basic control page

The basic operations of the unit can be performed.
Click [Display control] → [Basic control].

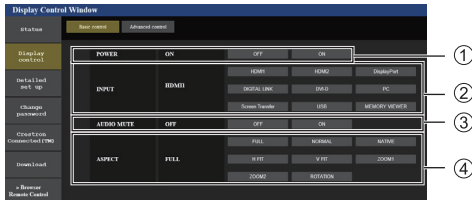

- ① Power On/Off control
- ② Use these to select the input signals
- ③ AUDIO mute
- ④ Switches aspect mode

■ Detail control page

The detailed functions of the unit can be performed.
Click [Display control] → [Advanced control].

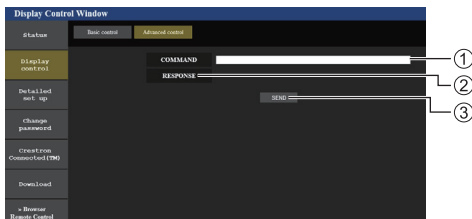

- ① Enter a command. Use the same command used for the serial control.
- ② Response from the unit is displayed.
- ③ Command is sent and run.

Note

- After the settings are changed, it may take a while till the display status is displayed.

■ Detailed set up

When connecting by logging in with administrator privileges, you can make detailed settings for network related to display.

■ LAN settings page

1 Click [Detailed set up] in the menu.

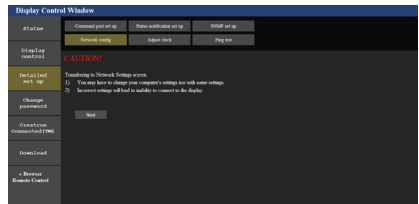

2 Click [Next].

The settings window appears, showing the current settings.

- To change the LAN settings, click [Change].
- To return to the previous window, click [Back].

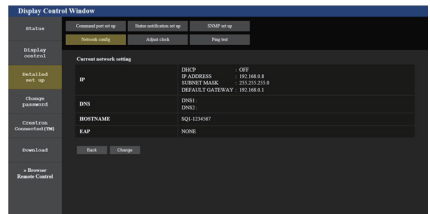

3 Complete the detailed settings and click [Next].

In this window, DNS server and HOSTNAME (up to 20 characters) settings can be made as well as address information set on the [LAN setup] menu of the display.

After all required items have been entered, click [Next]. Then, a confirmation window appears when [EAP] is set to [NONE].

When [EAP] is set to items other than [NONE], the next page appears.

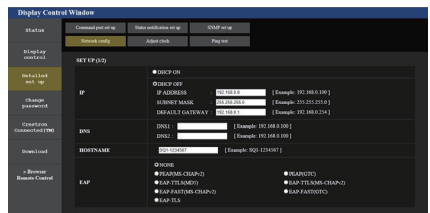

Note

- When [DHCP ON] is set, if the DNS server address is acquired from the DHCP server, the acquired address is valid.
- For 98 and 86 inch models, [EAP] is displayed only when the main software version is 4.0000 or later.

When [EAP] is set to items other than [NONE] or [EAP-TLS]

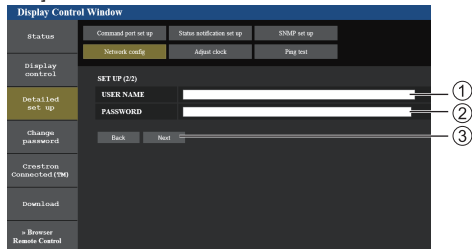

When [EAP] is set to [EAP-TLS]

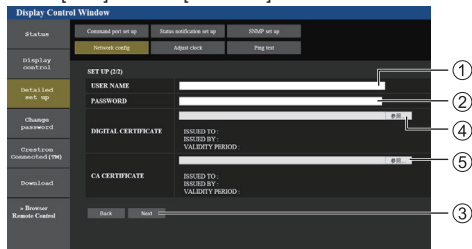

① [USER NAME]

Enter the user name for authentication with one-byte alphanumeric characters (excluding space). (Up to 64 characters)

② [PASSWORD]

Enter the password for authentication with one-byte alphanumeric characters. (Up to 64 characters)

③ [Back], [Next]

Click [Back] to return to the previous screen.
Click [Next] to display the screen to confirm the setting contents.

④ [DIGITAL CERTIFICATE]

Register the electronic certificate (extension: PFX) for authentication.

⑤ [CA CERTIFICATE]

Register the CA certificate (extension: CER) for authentication.

Note

- When [EAP] is [EAP-TLS], date and time need to be set on the adjust clock page (see page104).
- HOSTNAME setting is displayed only when the main software version is 4.0200 or later.

4 Click [Submit].

The settings will be registered.

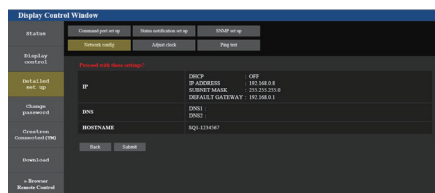

Note

- Changing the setting of LAN while connected with LAN might disconnect the connection.

■ Adjust clock page

Sets the clock-related items of this unit.

Click [Default set up] → [Adjust clock].

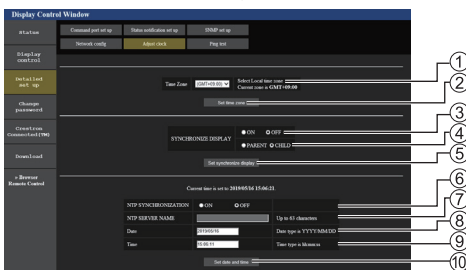

① Time zone selection field

② Time zone setting refresh button

③ Display synchronization selection field

④ Parent/Child selection field for display synchronization

⑤ Display synchronization setting refresh button

⑥ NTP synchronization selection field

⑦ NTP server input field

(When setting date and time with NTP synchronization, enter the IP address or server name. To enter the server name, setting the DNS server is required.)

⑧ Date entry field

⑨ Time entry field

⑩ NTP synchronization setting and date setting refresh button

Note

- Date and time is displayed as [- -] when they are not set.
- When [Network control] is set to [On] and it is in standby mode, date and time display will be blank and they cannot be set. [Time zone], [Synchronize display] and [NTP synchronization] cannot be set as well.
- When [SYNCHRONIZE DISPLAY] is set to [ON] / [CHILD], it is not possible to set [NTP SYNCHRONIZATION], [Date] or [Time].
- When [NTP SYNCHRONIZATION] is set to [ON], it is not possible to set [Date] or [Time].
- If the time becomes incorrect immediately after setting the correct time, contact the dealer where you bought the Display.
- [NTP synchronization] operates only in power-on state or in schedule standby state.

■ Ping test page

This page makes it possible to check whether the network is connected to the DNS server, etc.

Click [Detailed set up] → [Ping test].

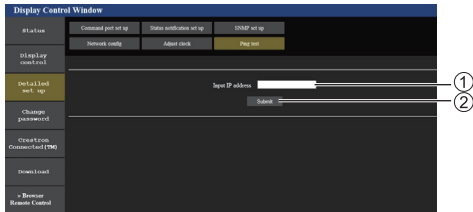

- ① Enter the IP address of the server to be tested.
- ② Button for conducting the test

Display which appears when the connection was successful.

```
PING 192.168.0.60 (192.168.0.60): 56 data bytes
64 bytes from 192.168.0.60: seq=0 ttl=128 time=1.474 ms
64 bytes from 192.168.0.60: seq=1 ttl=128 time=1.255 ms
64 bytes from 192.168.0.60: seq=2 ttl=128 time=1.146 ms
64 bytes from 192.168.0.60: seq=3 ttl=128 time=1.052 ms

--- 192.168.0.60 ping statistics ---
4 packets transmitted, 4 packets received, 0% packet loss
round-trip min/avg/max = 1.052/1.231/1.474 ms
```

Display which appears when the connection failed.

```
PING 192.168.0.100 (192.168.0.100): 56 data bytes
--- 192.168.0.100 ping statistics ---
4 packets transmitted, 0 packets received, 100% packet loss
```

■ Command port set up page

Set the port number to be used with command control.

Click [Detailed set up] → [Command port set up].

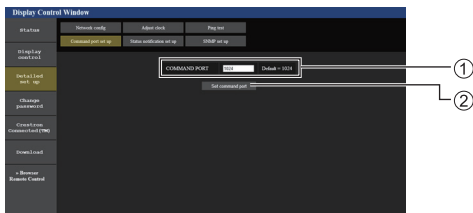

- ① Input the port number to be used with command control.
- ② Setting update button.

■ Status notification set up page

Sets the IP address and port number of the PC where "Multi Monitoring & Control Software (see page 98)" is operating when informing the PC of the status of this unit.

Click [Detailed set up] → [Status notification set up].

When the status notification is set, if the unit is malfunctioning and its power indicator is blinking red, the trouble content can be recognized even at a remote location where the power indicator cannot be directly checked.



- ① Selection field of status notification
- ② IP address input field for notification destination PC
- ③ Port number input field for notification destination PC
- ④ Update button for the settings

■ SNMP set up page

Sets the various items for SNMP.

SNMP (Simple Network Management Protocol) is a protocol to manage devices connected to the network.

If the SNMP manager is used for connection, the information of the target device can be obtained, and its settings can be changed.

Click [Detailed set up] → [SNMP set up].

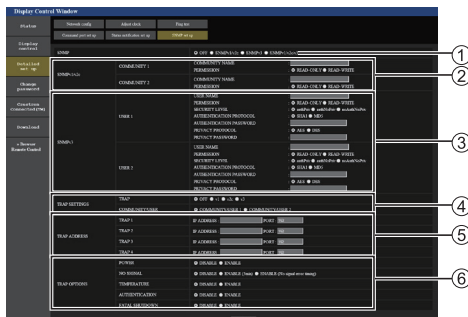

- ① [SNMP]:
Select the SNMP version to use.
- ② [SNMP v1/v2c] [COMMUNITY]
[COMMUNITY NAME]:
Enter the community name of SNMP v1/v2c.
[PERMISSION]:
Select whether to obtain only information via SNMP v1/v2c or to both obtain information and make the setting.

③ **[SNMP v3] [USER]**

[USER NAME]:

Enter the user name of SNMP v3.

[PERMISSION]:

Select whether to obtain only information via SNMP v3 or to both obtain information and make the setting.

[SECURITY LEVEL]:

Select the security level for SNMP v3.

[AUTHENTICATION PROTOCOL]:

Select the authentication method for SNMP v3 from SHA1 and MD5.

[AUTHENTICATION PASSWORD]:

Set the authentication password of SNMP v3.

[PRIVACY PROTOCOL]:

Select the encryption method for SNMP v3 from AES and DES.

[PRIVACY PASSWORD]:

Set the encryption password of SNMP v3.

④ **[TRAP SETTINGS]**

[TRAP]:

Select the SNMP version to use when sending TRAP.

[COMMUNITY/USER]:

Select COMMUNITY/USER to use when sending TRAP.

When SNMP v1/v2c is selected as a SNMP version of TRAP, the COMMUNITY 1/2 setting is used. When SNMP v3 is selected, the USER1/2 setting is used.

⑤ **[TRAP ADDRESS]**

[ADDRESS]:

Set the IP address of the SNMP manager that gives notice of TRAP.

[PORT]:

Set the TRAP reception port number of the SNMP manager that gives notice of TRAP.

⑥ **[TRAP OPTIONS]**

[POWER]:

TRAP is sent if the unit enters the standby mode by "Power management", [No signal power off] or [No activity power off].

[NO SIGNAL]:

TRAP is sent if no-signal continues in the following conditions.

When set to [ENABLE(5min)]:

TRAP is sent if no-signal continues for 5 minutes.

When set to [ENABLE(No signal error timing)]:

TRAP is sent if no-signal error set with [Setup] – [Information timing] occurs. (see page 88)

[TEMPERATURE]:

TRAP is sent if the temperature error occurs.

[AUTHENTICATION]:

TRAP is sent if the SNMP authentication fails.

[FATAL SHUTDOWN]:

TRAP is sent if a fatal error that requires the power to be forcibly turned off occurs. However, all the fatal errors do not necessarily support TRAP.

Note

- The maximum number of characters that can be used for a community name is 32 with one-byte alphanumeric characters.
- The maximum number of characters that can be used for a user name and password is 32 with one-byte alphanumeric characters.
Note that the password must be set with 8 characters or more.
- Change the password periodically, and set one which is difficult to guess.
- The SNMP manager must be operating in the system configuration used.
- For MIB (Management Information Base) of this unit, see the web site below.
<https://panasonic.net/cns/prodisplays>
- For the settings of the SNMP manager, consult with the network administrator.

■ Change Use name / Password page

Sets the password.

Click [Change password].

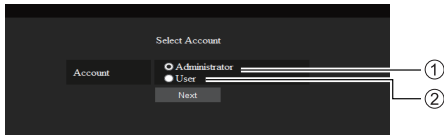

- ① Select [Administrator].
- ② Select [User].

About [Administrator]

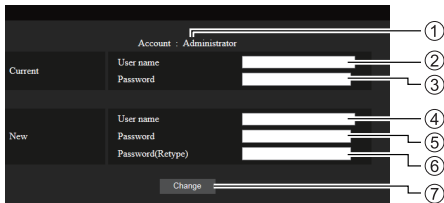

- ① Account
- ② Current user name input field
- ③ Current password input field
- ④ New user name input field
- ⑤ New password input field
- ⑥ New password input field (re-enter for confirmation)
- ⑦ Button for executing password change

Note

- If this unit has already been registered to application software such as "Multi Monitoring & Control Software" that uses communication control via LAN, changing an "Administrator" user name or password will disable the communication with this unit. If the "Administrator" user name or password is changed, update the registration information of applicable application software.

About [User]

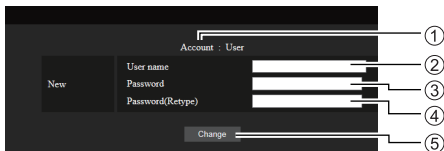

- ① Account
- ② New user name input field
- ③ New password input field
- ④ New password input field (re-enter for confirmation)
- ⑤ Button for executing password change

Password change (user rights)

A user can change password only.



- ① Current password input field
- ② New password input field
- ③ New password input field (re-enter for confirmation)
- ④ Button for executing password change

Note

- Alphanumeric characters can be used for a user name.
- Up to 16 characters can be used for a user name and a password.
- When changing the administrator account, both "current user name" and "current password" are required.
- See below when you log in with administrator privileges and change the account.
 - It is recommended not to use the current user name/password or default values for a new user name/password.
- See below when you log in with user privileges and change the password.
 - It is recommended not to use the current password or default value for a new password.
- It is recommended to use a password different from passwords of PC and other devices.
- The following are recommendations in complexity when changing passwords. (For both administrator privileges and user privileges)

Include at least 3 kinds of characters from the following 4, and the number of characters should be 8 or more.

- Alphabet upper case character (A to Z)
- Alphabet lower case character (a to z)
- Number (0 to 9)
- Special character
(~ ! @ # \$ % ^ & * () _ + | } { [] < > . , / ? ' ; etc.)

It is recommended to set the password using the above types of characters without leaving the password field blank.

■ Crestron Connected (Crestron Connected operation screen)

When connecting by logging in with administrator privileges, you can monitor or control the Display using "Crestron Connected".

If Adobe Flash Player is not installed in your computer, or if the browser does not support Flash, this page does not appear. In this case, return to the previous page by clicking [Back] in the operation page.

● Operation page

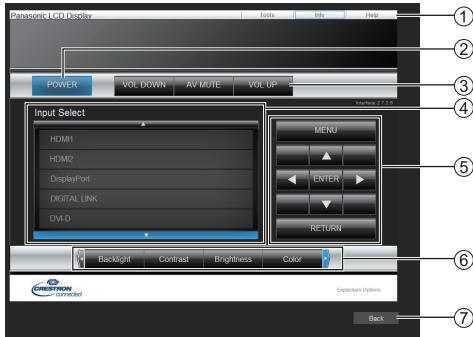

① [Tools], [Info], [Help]

Switches the pages for tools, information, help using the tab.

② [POWER]

Switches between on and off of the power.

③ [VOL DOWN], [AV MUTE], [VOL UP]

Sets the volume, AV mute.

When the power of the Display is turned off, these operations are not available.

④ [Input Select]

Sets the input selection.

When the power of the Display is turned off, this operation is not available.

⑤ Operation buttons on the menu screen

Operates on the menu screen.

⑥ Image quality adjustments

Operate items related to image quality.

⑦ [Back]

Returns to the previous page.

● [Tools] page

Click [Tools] on the operation page.

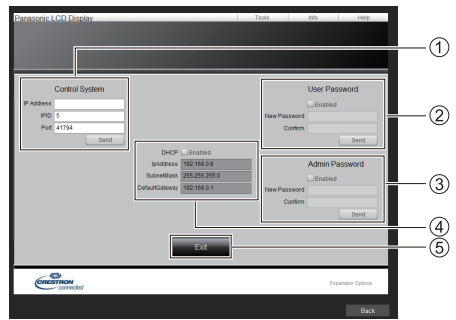

① [Control System]

Sets the information required for the communication with the controller that is connected to the Display.

② [User Password]

Sets the password for the user rights in the operation page of "Crestron Connected".

③ [Admin Password]

Sets the password for the administrator rights in the operation page of "Crestron Connected".

④ [Network Status]

Displays the setting of wired LAN.

- [DHCP]
- [IpAddress]
- [SubnetMask]
- [DefaultGateway]

Displays the value in the current setting.

⑤ [Exit]

Returns to the operation page.

Note

- When you monitor or control the Display using "Crestron Connected", set [Crestron Connected] to [On] in the [Network settings] menu.

- [Info] page

Click [Info] on the operation page.

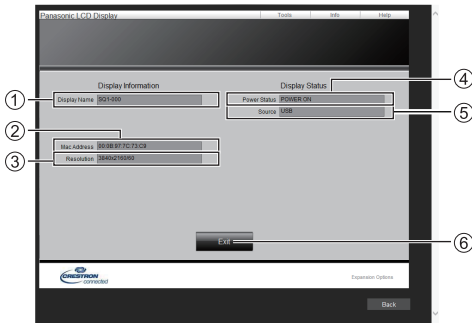

① **[Display Name]**

Displays the name of the Display.

② **[Mac Address]**

Displays the MAC address.

③ **[Resolution]**

Displays the resolution of the Display.

④ **[Power Status]**

Displays the status of the power.

⑤ **[Source]**

Displays the selected video input.

⑥ **[Exit]**

Returns to the operation page.

- [Help] page

Click [Help] on the operation page.

The [Help Desk] screen is displayed.

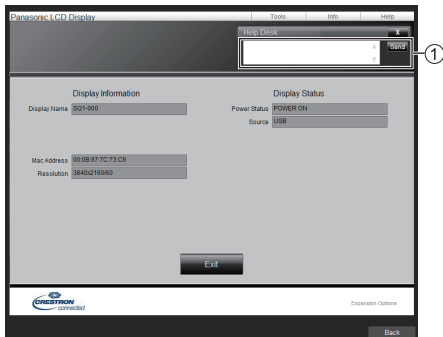

① **[Help Desk]**

Sends or receives messages to the administrator who uses “Crestron Connected”.

■ **[Download]**

“Screen Transfer” software that sends a screen of PC to the display via wired LAN can be downloaded.

Click [Download].

The download screen appears.

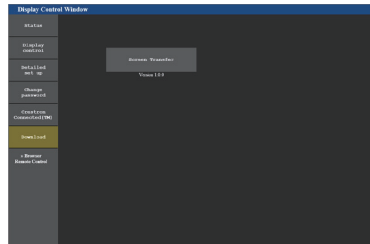

Click [Screen Transfer] to download the installer “setup.msi”.

After “Screen Transfer” is installed, the screen of PC can be sent to this unit via wired LAN.

- For more details, visit the following web site.
<https://panasonic.net/cns/prodisplays/>

Note

- For 98 and 86 inch models, [Download] is displayed only when the main software version is 4.0000 or later.

■ [Browser Remote Control]

It is possible to operate the display with the operation buttons displayed on the WEB browser.

Click [Browser Remote Control].

The [Browser Remote Control] screen is displayed.

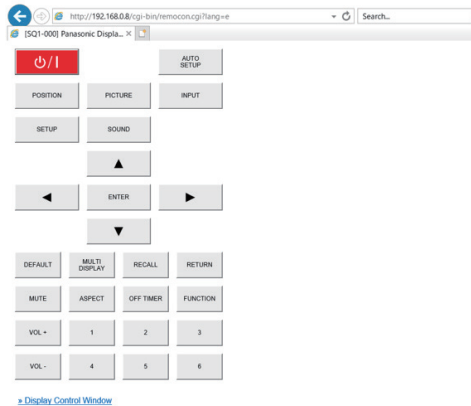

Browser Remote Control

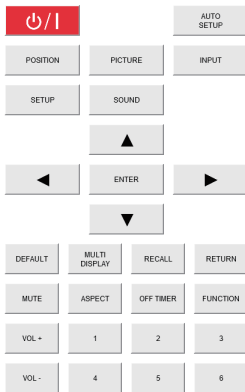

The Browser Remote Control can be operated in the same way as the supplied remote control.

For allocation / function of each button, see page 34.

To finish the Browser Remote Control, click [Display Control Window] or exit the browser.

Note

- To use this function, set [Network control] to [On]. (see page 77)
 - The Browser Remote Control can also be displayed by entering "http://xxx.xxx.xxx.xxx/remote/" in the WEB browser URL entry field.
 - xxx.xxx.xxx.xxx is the IP address set for this display.
 - The button long press operation is invalid.
- The restriction for the remote control button operation set for [Setup] - [Controller user level] (see page 89) does not apply.
 - Avoid operating the multiple Browser Remote Control simultaneously.
 - The same operations are applicable to both administrator privileges and user privileges.
 - If the Browser Remote Control screen is not displayed, consult your network administrator.
 - The screen may turn white for a moment when updating the Browser Remote Control screen, but it is not a malfunction.
 - While operating the Browser Remote Control, do not operate the unit by other methods such as WEB control screen, remote control and external control command.
 - If the "Back" or "Forward" functions on the WEB browser is used, the screen display may be abnormal. In this case, the subsequent operations are not guaranteed. Update the WEB browser.
 - For 98/86-inch models with main software version of less than 3.0000, the <MULTI DISPLAY> button on the Browser Remote Control is replaced with the <ZOOM> button.

Using “USB media player”

Function description

The USB media player displays still pictures and motion pictures saved in a USB memory by inserting the USB memory device into the display.

Note

- To use this function, set [USB media player] to [Enable] in [Setup] - [USB media player settings]. (see page 81)
- When using the “Single Media Player”, the unit prevents a black screen from appearing at the switching timing of still pictures or motion pictures. Note the following restrictions.

- (1) A black screen may appear when switching a motion picture codec.
- (2) A black screen may appear or images may be disturbed when switching to motion pictures of a different frame rate or aspect ratio.

If an angle of view for something other than for 16:9 is used, images may be disturbed near the end of playback.

Inserting a black screen (approx. 2 sec.) at the switching timing for all the motion pictures can avoid image disturbance in above (2).

([USB media player settings] (see page 81))

- Using the content list delivery function of the Multi Monitoring & Control Software (see page 98), content (still/motion pictures) played back on a USB media player and the playback list can be delivered.

(Still pictures in jpg files and motion pictures other than H.265/HEVC can only be delivered.)

For details, refer to the manual of Multi Monitoring & Control Software.

Single Media Player

Files are played by a single unit.



Multi Media Player

Connecting more than one unit using LAN cables plays back files in the USB memory simultaneously.

One of the multiple units becomes the parent, and the others are children. The two-unit configuration example is shown below.

For LAN connection, see “Network environment (Multi Media Player only)” (see page 117).

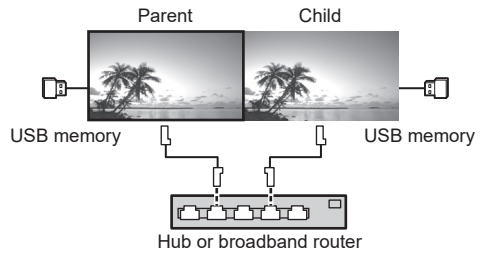

Note

- For Multi Media Player, one USB memory device is required for one unit.
- For Multi Media Player, the parent requires both “scenario.dat” and “filelist.dat”, and the child requires “filelist.dat” only.
- Describe “GroupID:G01” without changing characters other than numbers (2-digit description required). Without description, the Multi Media Player does not function.
- When motion pictures are played on the multi media player, a black screen may be displayed for a certain period of time at the switching timing of motion pictures.

Preparation

■ Supported device

- Commercially available USB memory devices are supported. (Those with security functions are not supported. Operation is not guaranteed.)
- USB memory devices other than those formatted in FAT16 or FAT32 cannot be used.
- Up to 32 GB of USB memory in size are supported.
- Only single partition configuration is supported.

■ Preparation

Prepare the following files immediately below root in USB memory for the media player.

- Play file
- Scenario (as necessary)
- File list (as necessary)

Note

- Delete files irrelevant to playback from the USB memory device.
 - Up to 999 files can be played back. If more than the maximum number of files are present, some files are not played back.
- An error is displayed by the scenario file check (see page 81).
- Up to 999 lines of Scenario files are valid.

■ Play file

The unit's Media Player supports the formats below.

Save immediately below root in USB memory.

Still pictures

| Extension | Format | Limitation |
|----------------------|-------------------|---|
| jpg/ jpeg/ jpe | JPEG | Number of pixels: Minimum 32 x 18 Maximum 4 096 x 4 096 (supports baseline only) YUV format: supports YUV444, YUV442 and YUV440 Colour mode: supports RGB only |
| bmp | Windows Bitmap | Number of pixels: Minimum 32 x 18 Maximum 4 096 x 4 096 (1 bit, 4 bits, 8 bits, 24 bits) Following formats are not supported: Run-length encoding, bit field, top-down, transparent data |

Motion pictures

| Extension | Codec | |
|-----------------|--|--------------------------------------|
| | Video | Audio |
| avi | H.264/MPEG4 AVC MPEG4 Visual VC-1 Advanced VC-1 Simple & Main | AAC-LC/LPCM/MP3/WMA Standard |
| mkv | H.264/MPEG4 AVC MPEG4 Visual VC-1 Advanced VC-1 Simple & Main H.265/HEVC | AAC-LC/HE-AAC/LPCM/MP3 |
| wmv asf | H.264/MPEG4 AVC MPEG4 Visual VC-1 Advanced VC-1 Simple & Main | LPCM/MP3/WMA Standard/WMA9/WMA10 Pro |
| mp4/ mov/flv | H.264/MPEG4 AVC MPEG4 Visual H.265/HEVC | AAC-LC/HE-AAC/MP3 |
| ts/mts | H.264/MPEG4 AVC H.265/HEVC | AAC-LC/HE-AAC/LPCM/MP3 |

Limitation

| Video | | |
|--|--|-----------------|
| Codec | Resolution | |
| H.264/ MPEG4 AVC MP@L5.1/ HP@L5.1 | 1 920 x 1 080p@60.0 3 840 x 2 160p@30.0 Bit rate: Maximum 80Mbps • MVC (Multi-view Video Coding) is not supported. | |
| H.265 MP@L5.1/ MP10@L5.1 | 3 840 x 2 160p@60.0 1 920 x 1 080p@60.0 Bit rate: Maximum 80Mbps • Only 1 warp-point GMC supported • Data Partitioning is not supported. | |
| MPEG4 Visual SP@L5/ ASP@L5 | 1 920 x 1 080p@30.0 Bit rate: Maximum 40Mbps • Video standard specified by MPEG4 Part2 | |
| VC-1 Advanced AP@L3 | 1 920 x 1 080i@30.0 1 920 x 1 080p@24.0 Bit rate: Maximum 40Mbps | |
| VC-1 Simple & Main SP@LL/SP@ ML/MP@LL/ MP@ML/ MP@HL | 1 920 x 1 080p@30.0 Bit rate: Maximum 40Mbps | |
| Audio | | |
| Codec | Sampling frequency (kHz) | Bit rate (kbps) |

| | | |
|-----------------------|-------------------|---|
| MP3 | 8/11.025/12/16/ | 8 – 320 |
| WMA Standard | 22.05/24/32/44.1/ | 32 – 384 |
| WMA 9 | 48 | 32 – 384 |
| WMA 10 Pro | | 32 – 384 |
| LPCM | | 64 – 1 536 |
| | | Supported quantization bit: 8/16/24/32 |
| AAC(LC) | | 8 – 1 440 |
| HE-AAC (Ver.2 Level4) | | 8 – 256 |

Note

- A maximum bit rate is the upper limit on the USB 3.0 memory, and depends on the performance of a USB memory device to be used.
- Maximum size per one file is 2 GB.
- Some files may not be played back even if their formats are supported as described here.
- Files protected by Digital Rights Management (DRM) cannot be played back.
- If files or folders include characters other than one-byte alphanumeric characters, they may not be displayed correctly, or the playback may not be done properly.

It is recommended to use only one-byte alphanumeric characters for files and folders.

- Make sure that both audio codec and video codec are supported. If the audio codec of motion picture file is incompatible in format, the pictures may not be correctly displayed. In addition, files which contain only audio cannot be played back.
- Playback is not possible if the maximum bit rate specified in the codec Profile or Level is exceeded. Also, depending on the USB memory device, playback may be impossible even if the bit rate is less than the indicated maximum bit rate.
- If the number of pixels of a file exceeds the screen size, the picture quality will change.
- Depending on the type of motion picture, the images may be distorted momentarily during playback.
- A part of information of still pictures/motion pictures can be confirmed on the computer accessible to the target files.

Example of an operation

(Windows)

1. Right-click the file, and then click [Properties].
2. Click the [Details] tab.

(Mac)

1. Control-click the file, and then click [Get Info].
2. Click [Details].

■ Scenario

The play order and time can be specified for a play file. Save under the name (one-byte alphabetical characters) "scenario.dat" immediately below root in USB memory.

- Save files as UTF-8N format.
- 1 to 999 lines can be specified for Scenario.

■ File list

It is a list of play files.

Save under the name (one-byte alphabetical characters) "filelist.dat" immediately below root in USB memory.

- Save files as UTF-8N format.

■ Scenario- / File list-associated terms

File name

It is the name of a play file.

A file name needs to include its extension.

Example:

Introduction.jpg
Contents_Video01.wmv

- Enter the extension of a file name using one-byte alphanumeric characters.

File definition

It is a file definition that is shared among scenarios and files.

PHOTO_xxx: still image file definition
VIDEO_xxx: moving image file definition

- The "xxx" portion can be set from 001 to 999.
- Enter a file definition using one-byte alphanumeric characters.

Play time

It is the play time of a file.

Play time can be specified from 3 seconds to 24 hours. (Unit: second)

Example:

10: 10 seconds
86400: 24 hours
10.5: 10.5 seconds

It can be set down to one-tenth (1/10) of a second using a decimal point (full stop).

Play time is omissible.

For still images, a file will be played for the period of time that you selected in [USB media player settings] - [Slide show duration]. (see page 82)

For moving images: a file will be played for the duration of the play time of the file.

- Enter play time using one-byte numeric characters.
- When playing back large sized files, if you set the playing back duration short, it may not be played back properly, for example, noise appears on the screen. In that case, set the playing back duration longer (10 seconds or longer).
- If play time for a motion picture longer than the play time of the motion picture file is specified, the last image of the file is displayed after the playback of the motion picture has finished.

Group ID (for Multi Media Player)

It is an ID used for grouping on a network during Multi Media Player conditions.

GroupID:Gxx : Group xx

- The "xx" portion can be set from 01 to 10.
- Enter a group ID using one-byte alphanumeric characters.

Note

- "UTF-8N": UTF-8 encoding without BOM. Notepad for windows doesn't support this encoding.
Please use another editor supported UTF-8 encoding without BOM.

Playing back the files

■ Example of setting in each mode

Single Media Player (Type 1)

Files will be played in the order in which their names appear in USB memory.

Scenario and file list

Scenario:

Unnecessary

File list:

Unnecessary

Setting example

USB memory contents

```
├─ 000_Introduction.jpg
├─ 001_Contents_Video1.wmv
├─ 002_Contents_Video2.wmv
├─ 003_Contents_Video3.wmv
```

Play contents

For the above setting example, the following contents will be played on repeat (loop).

1. 000_Introduction.jpg (*1)
2. 001_Contents_Video1.wmv (*2)
3. 002_Contents_Video2.wmv (*2)
4. 003_Contents_Video3.wmv (*2)

*1: Played for the duration set in [Slide show duration].

*2: Played for the duration of the play time of the file.

Single Media Player (Type 2)

Files will be played in the order they were listed in a scenario.

Scenario and file list

Scenario:

Enter [File name: Play time].

File list:

Unnecessary

Setting example

USB memory contents

```
├─ scenario.dat
├─ Introduction.jpg
├─ Contents_Video1.wmv
├─ Contents_Video2.wmv
├─ Contents_Video3.wmv
```

scenario.dat (scenario)

```
Introduction.jpg:10
Contents_Video1.wmv:10
Contents_Video2.wmv:20
Contents_Video3.wmv:
```

Play contents

For the above setting example, the following contents will be played on repeat (loop).

1. Introduction.jpg (10 seconds)
2. Contents_Video1.wmv (10 seconds)
3. Contents_Video2.wmv (20 seconds)
4. Contents_Video3.wmv (Played for the duration of the play time of the file)

Single Media Player (Type 3)

Files will be played in the order they were listed in a scenario.

Scenario and file list

Scenario:

Enter [File definition: Play time].

File list:

Enter [File definition: File name].

Setting example

USB memory contents

```
└─ filelist.dat
  └─ scenario.dat
    └─ Introduction.jpg
      └─ Contents_Video1.wmv
        └─ Contents_Video2.wmv
          └─ Contents_Video3.wmv
```

scenario.dat (scenario)

```
PHOTO_001:10
VIDEO_001:10
VIDEO_002:20
VIDEO_003:
```

filelist.dat (file list)

```
PHOTO_001:Introduction.jpg
VIDEO_001:Contents_Video1.wmv
VIDEO_002:Contents_Video2.wmv
VIDEO_003:Contents_Video3.wmv
```

Play contents

For the above setting example, the following contents will be played on repeat (loop).

1. Introduction.jpg (10 seconds)
2. Contents_Video1.wmv (10 seconds)
3. Contents_Video2.wmv (20 seconds)
4. Contents_Video3.wmv (Played for the duration of the play time of the file)

Multi Media Player

Files will be played in the order they were listed in the scenario for Parent.

Scenario and file list

Parent side

Scenario:

Enter [File definition: Play time].

File list - The first line:

Enter [Group ID].

File list - The second and subsequent lines:

Enter [File definition: File name].

Child side

Scenario:

Unnecessary

File list - The first line:

Enter [Group ID].

File list - The second and subsequent lines:

Enter [File definition: File name].

Setting example

Parent side

USB memory contents

```
└─ filelist.dat
  └─ scenario.dat
    └─ L_Introduction.jpg
      └─ L_Contents_Video1.wmv
        └─ L_Contents_Video2.wmv
          └─ L_Contents_Video3.wmv
```

scenario.dat (scenario)

```
PHOTO_001:10
VIDEO_001:10
VIDEO_002:20
VIDEO_003:
```

filelist.dat (file list)

```
GroupID:G01
PHOTO_001:L_Introduction.jpg
VIDEO_001:L_Contents_Video1.wmv
VIDEO_002:L_Contents_Video2.wmv
VIDEO_003:L_Contents_Video3.wmv
```

Child side

USB memory contents

```
└─ filelist.dat
  └─ R_Introduction.jpg
    └─ R_Contents_Video1.wmv
      └─ R_Contents_Video2.wmv
        └─ R_Contents_Video3.wmv
```

filelist.dat (file list)

```
GroupID:G01
PHOTO_001:R_Introduction.jpg
VIDEO_001:R_Contents_Video1.wmv
VIDEO_002:R_Contents_Video2.wmv
VIDEO_003:R_Contents_Video3.wmv
```

Play contents

For the above setting example, the following contents will be played on repeat (loop).

Parent side

1. L_Introduction.jpg (10 seconds)
2. L_Contents_Video1.wmv (10 seconds)
3. L_Contents_Video2.wmv (20 seconds)
4. L_Contents_Video3.wmv (*1)

Child side

1. R_Introduction.jpg (10 seconds)
2. R_Contents_Video1.wmv (10 seconds)
3. R_Contents_Video2.wmv (20 seconds)
4. R_Contents_Video3.wmv (*1)

*1: Played for the duration of the play time of L_Contents_Video3.wmv (Parent side).

Note

- While the menu screen is not displayed, you can skip to the next playback file with ►, to the previous playback file with ◀, or play back again from the beginning of the file with ▼ (Remote control operation only).

When this operation is performed, a black screen is inserted before playback.

- If the date and time are changed by the [Date and time] (see page 76) setting, the playback of the file currently being played is stopped, and the playback will be performed again from the beginning of the file.

■ USB memory contents check

You can run a USB memory contents check in [USB media player settings] - [Scenario file check]. (see page 82)

If an error is present, the information is given with the following details.

A(B): C
D

- A: Name of the file with an error
- B: Row with an error
- C: Error code
- D: Detail of the error

Note

- Shows leading error codes.

Details of the detected errors are as follows.

| Error code | Detail of the error |
|------------|---|
| 1. | No USB memory is inserted. |
| 2. | scenario.dat/filelist.dat cannot be opened. |
| 3. | There is an error in the contents of scenario.dat/filelist.dat. |
| 4. | The play file format is not supported. |
| 5. | No play file exists. |
| 6. | The necessary group ID for Multi Media Player has not been specified. |
| 7. | There are several identical file definitions. |
| 8. | The scenario's play time is over the limit. |
| 9. | The file definition listed in the scenario is not in the file list. |
| 10. | The scenario contains 0 or over 1000 play files. |
| 11. | There are 0 or over 1000 play files. (Single Media Player (Type 1) only) |
| 12. | Only the group ID is listed on the file list. (Multi Media Player only) |

- For error code 1 and 11, only the error code and the detail of the error are displayed as shown below.

1

No USB memory is inserted.

Supplementary note

The USB memory contents check does not determine whether or not a play file is playable.

If a file cannot be played while Media Player is active, an error message will be displayed.

When performing the synchronized playback on the Multi Media Player, check in the menu [USB media player settings] - [Scenario file check] that the file is playable.

Network environment (Multi Media Player only)

■ Example of setting up LAN connection and IP address / Subnet mask

As mentioned below, connect several units together with LAN cables and set up IP addresses / Subnet masks so that all the displays exist on the same network.

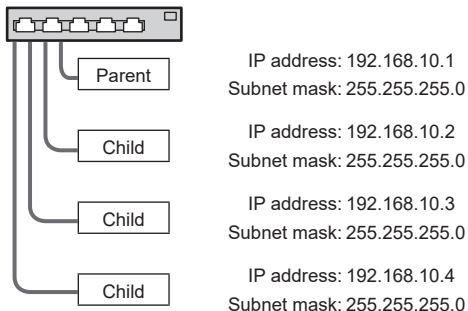

Note

- Set [Network control] of all displays to [On]. (see page 77)
- Depending on the network environment, synchronization may be largely lost.
- Do not connect other devices to prevent network traffic jam.
- With a router put in between the displays, you cannot set up connection. Use them within the same subnet.
- Do not use wireless LAN for connection since playback may not be performed normally.

Starting / ending Media Player

Note

- Select the USB terminal to be used with [USB select]. (see page 90)
- Depending on the USB terminal, the amount of electricity supplied to an external device differs. (“USB terminal connection”, see page 30)

■ For Single Media Player

Start

1. Insert the USB memory device for Media Player to the USB terminal on the bottom of the display.

Note

- Depending on the type of a USB memory device, it may come in contact with the periphery such as a back cover, and cannot be attached. Use a USB memory device connectable to this unit.

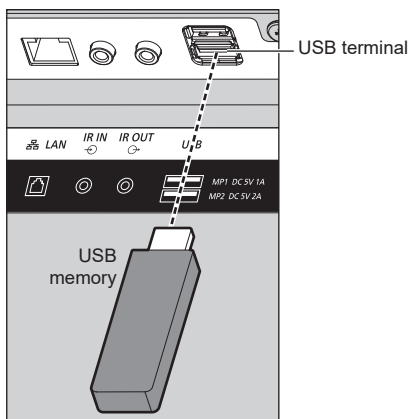

2. Run a USB memory contents check.
3. Change INPUT to [USB].

Ending

Change INPUT to other than [USB].

■ For Multi Media Player

Start

1. Connect several units with LAN cables.
(See “Example of setting up LAN connection and IP address / Subnet mask” in the previous section.)
2. Insert USB memory for Media Player into each Display.
3. Executes USB memory contents check on each Display.
4. Change INPUT for Child to [USB].
5. Change INPUT for Parent to [USB].

Ending

Change INPUT for Parent to other than [USB].

Resume Play function

After Media Player ends, the file to be played back next time varies depending on the setting of [USB media player settings] - [Resume play].

When set to [On]:

The file played prior to the end of Media Player starts playing from the beginning.

When set to [Off]:

Play starts from the beginning of the first file of the scenario.

Note

- The resume play function is retained until the unit is turned off or the USB memory device is taken out.

Playlist edit function

This function creates and edits a scenario file for the USB media player. Select [Setup] – [USB media player settings] – [Playlist edit] to select the desired content, set the playback order and play time, and output the file (scenario.dat) to the USB memory device.

Note

- Descriptions for the scenario (scenario.dat) are restricted by the USB media player.
- After the playlist is edited, "Single Media Player (Type 2)" operates.
- If a scenario file (scenario.dat) already exists in the USB memory device, delete it, and create a new one.
- If a file list file (filelist.dat) already exists in the USB memory device, delete them.
- While editing the playlist, the following functions are disabled.

[Position]

[Sound]

[Picture]

[Setup]

- [Signal]
- [Input label]
- [Power management settings] - [No signal power off]
- [Image settings] - [Read user image]
- [Multi display settings]
- [Function button settings]
- [Failover/Failback]
- [Audio input select]

[Digital zoom]

- The screen and audio quality while editing the playlist is adjusted with the same content as that for the MEMORY VIEWER input.
- Editing the playlist requires 2 MB or more of space in the USB memory device.
- Use a USB memory device for which file reading and writing can be normally performed.
- Use the remote control for the playlist editing function operation.

1. File selection screen

Select content files to play.

After selecting the files, press <6> to go to the next editing screen.

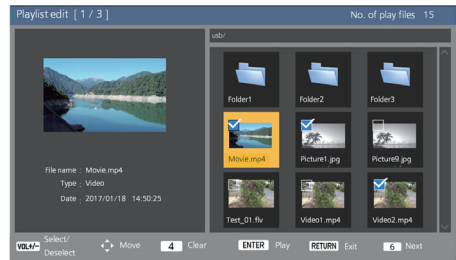

Press the remote control buttons to perform the following operations.

<VOL +> Selects content files. (Add a check mark on the upper left of the thumbnail.)

<VOL -> Cancels content selection. (Delete a check mark on the upper left of the thumbnail if there is.)

▲ ▼ ◀ ▶ Moves the focus.

<4> Deletes all the check marks.

<ENTER> Plays content files or moves to a different hierarchy.

<RETURN> Finishes editing the playlist or moves to a higher hierarchy.

<6> Goes to the next editing screen.

Note

- If a scenario (scenario.dat) exists in the USB memory device, it will be loaded automatically. If applicable files are present, they are already in the selected status on the content selection screen.
- Up to 999 lines can be read from a scenario (scenario.dat).
- If a file list (filelist.dat) exists in the USB memory device, it will not be loaded even if a scenario (scenario.dat) is present, and then the content selection screen appears with no content files selected.
- In addition to files immediately below root in the USB memory device, files in folders can also be selected.
- A maximum of 999 content files can be selected.
- If 999 files are selected, pressing <VOL +> for files not selected cannot select such files.
- When all the check marks are removed with <4>, a confirmation screen is displayed before removal.

2. Play order / Play time setting screen

Arrange the selected content files in playback order, and set the playback time.

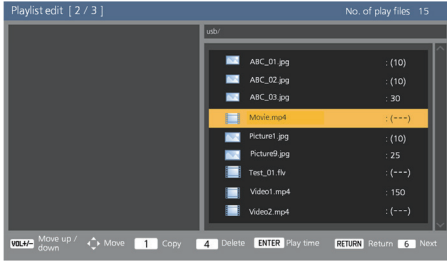

Press the remote control buttons to perform the following operations.

- <VOL +> Moves a content file up by one position.
- <VOL -> Moves a content file down by one position.
- ▲ ▼ ◀ ▶ Moves the focus.
- <1> Copies the currently selected content file to add it to the list.
- <4> Deletes the currently selected content file from the list.
- <ENTER> Displays a screen to set playback time.
- <RETURN> Returns to the previous editing screen.
- <6> Goes to the next editing screen.

Pressing <ENTER> will display a screen to set playback time.

Entering numbers (see page 78)

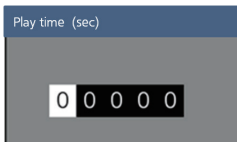

Note

- The setting range for playback time is 0, 3 (minimum) to 86400 (maximum). If 0 is set, the playback time setting is deleted.
- Playback time can be set in one second increments with the playlist editing function. If a scenario (scenario.dat) is already present and the playback time of the applicable files are specified with decimal points, writing the scenario file will convert the playback time to that in one second increments.

- For content files whose playback time is set, “:(number)” is displayed on the right side of the file name.

For content files whose playback time is not set, “:(number)” is displayed on the right side of the file name if they are still picture files. (The numbers are values set for [USB media player settings] - [Slide show duration] (see page 82).) For motion picture files, “:(---)” is displayed on the right side of the file name.

- When the content file is deleted with <4>, a confirmation screen is displayed before deletion.
- If 999 content files already exist, another file cannot be added even if <1> is pressed.

3. File output screen

Select [Yes] with ◀▶ and press <ENTER>.

File output to the USB memory device starts.

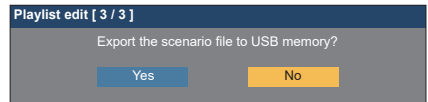

4. Exit screen

The exit screen appears.

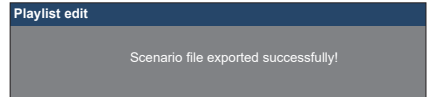

Schedule playback function using "Content Management Software"

This unit supports "Content Management Software" to create schedule data on a PC required to play back still pictures and motion pictures.

Functions that can be set with "Content Management Software" are as follows.

- Content playback (Still pictures/Motion pictures)
- Music playback
- Input switch
- Power control
- Multi screen display setting of the multi display
- Caption display

For setting method and details of each function, refer to the manual of "Content Management Software".

Note

- To use this function, set [USB media player] and [Schedule play function] to [Enable] in [Setup] - [USB media player settings]. (see page 81)
- About supported devices, refer to "Supported device". (see page 112)
- When using this function, insert the USB memory device in power-on state or in schedule standby state. If the USB memory device is inserted in conditions other than the said states, the schedule playback is not performed.
- Functions restricted when using the "USB media player" are also restricted when using the schedule playback function.

■ Schedule play mode

When [USB media player] is set to [Enable] and [Schedule play function] is set to [Enable], this unit enters schedule play mode, and the content is played back according to the set schedule.

If it entered schedule play mode at the time when the schedule is already specified, the unit operates as follows according to [Play mode] (see page 82).

- In [Individual play] mode
Playback starts from the beginning of the specified schedule.
- In [Synchronize play] mode
Synchronized playback starts at the next content start time.

Note

- When the unit enters schedule play mode, the input is automatically switched to [USB].
- Some of the main unit's functions are disabled during schedule play mode.
- If the input is switched during schedule play mode, the schedule playback is suspended.

To resume the schedule playback

- Switching the input to [USB] will resume playback from the next schedule.
- If the power is turned off using the remote control, the power is turned on at the next power-on schedule. Then the schedule playback starts.

The schedule playback is restored by the above operations.

- When <RECALL> is pressed during schedule play mode, the [Schedule play mode] display appears.
- The scenario playback function of the media player does not operate in [Schedule play mode].

■ Content playback

Specified content is played back at the time set for schedule.

Playback files in the following formats are supported.

Still pictures

| Extension | Format | Limitation |
|----------------------|-------------------|--|
| jpg/ jpeg/ jpe | JPEG | Number of pixels: Minimum 32 x 18 Maximum 4 096 x 4 096 (supports baseline only) YUV format: supports YUV444, YUV442 and YUV440 Colour mode: supports RGB only |
| bmp | Windows Bitmap | Number of pixels: Minimum 32 x 18 Maximum 2 000 x 2 000 (1 bit, 4 bits, 8 bits, 24 bits) Following formats are not supported: Run-length encoding, bit field, top-down, transparent data |

Motion pictures

| Extension | Codec | |
|--------------|---|--|
| | Video | Audio |
| avi | H.264/MPEG4 AVC MPEG4 Visual VC-1 Advanced VC-1 Simple & Main | AAC-LC/LPCM/MP3 WMA Standard |
| wmv | H.264/MPEG4 AVC MPEG4 Visual VC-1 Advanced VC-1 Simple & Main | LPCM/MP3/ WMA Standard/WMA9/ WMA10 Pro |
| mp4 / mov | H.264/MPEG4 AVC MPEG4 Visual H.265/HEVC | AAC-LC/HE-AAC/MP3 |

Note

- Some files may not be played back even if they are supported formats described above.
- As for restrictions for movie codecs of playback files, see "Play file" (see page 112).
- If the contents of setting files (under [PRIVATE] folder) created and delivered using "Content Management Software" are changed, operations are not guaranteed.
- During a time period for which no content is set, the screen is black with nothing displayed.
During this period, the [Schedule waiting] message is displayed on the upper right of the screen.
To hide this display on the screen, set [Setup] - [OSD settings] - [Onscreen display] to [Off].
- For details of each CODEC of content, check the restriction items for playback content of the USB media player function.

■ Music playback

Music content is played back at the time set with the schedule data.

Playback files in the following formats are supported.

Music

| Extension | Codec | Format |
|-----------|--------------------------------------|---|
| mp3 | MPEG-1/2 Audio Layer-3 AAC(LC) | Sample rate: Maximum 48 kHz Channel: Maximum 2 ch |
| wma | WMA | Bit rate: Maximum 320kbps |

Note

- Some files may not be played back even if they are supported formats described above.
- If incompatible music content is scheduled, the music content is not played back.
- Music content can be played back only with the USB input.
- Video content and music content cannot be played back simultaneously. If 2 pieces of content are set for playback at the same time, video content takes priority.
- If video content starts to be played back while music content is being played, the playback of the music content stops.
- When playing back music content after playback of video content has finished, the playback starts from the beginning of the music content.
- Music content cannot be played back in synchronization with other displays.
- Several minutes of preparation time are added in switching music content.

■ Input switch

The input is switched to [HDMI1] at the time set with the schedule data. When the set time has passed, the [USB] input is restored.

Note

- The input is switched only to [HDMI1].
- The input is switched even if no signal is present at the input switch destination.
- When the input is switched, the input display does not appear.

■ Power control

The power is turned on/off at the time set with the schedule data.

Note

- If the power is turned off during schedule play mode, the unit enters the schedule standby mode.
- The standby electricity will be more than normal during the schedule standby mode.
- Some of the main unit functions in schedule play mode remain invalid during the schedule standby mode.
- The power-on schedule operates one minute before the specified schedule time.
- If the unit enters the schedule standby mode after one minute before the power-on schedule, the power is not turned on at the specified time by the schedule playback function.
- The power-on operation by [Schedule play function] does not work in standby states other than the schedule standby mode.

■ Multi screen display setting of the multi display

Sets the following for playback content.

- Plays in the single playback mode.
- Plays in the synchronized playback mode.
- Changes the setting of [Multi display settings] - [Multi screen display] of the main unit.

In [Individual play] mode

Content is played only on one display.

In [Synchronize play] mode

Content is played on multiple displays in synchronization.

To play back in the synchronized playback mode, set the following for correct operation.

- Set [USB media player] to [Enable].
- Set [Schedule play function] to [Enable].
- Set [Synchronize display] to [On].
- For [Parent or child setting], set one display with reference time to [Parent] and other displays to [Child].

Note

- The operations of the single playback mode and the synchronized playback mode are different from those of Single Media Player and Multi Media Player of the existing USB media player.
- For playback in the synchronized playback mode, approx. 5 seconds of preparation time are added in switching content.
- To perform the synchronized playback with multiple displays, set the [Synchronize display] function to [On], and set the same time for all the displays for playback.
- If the time is not synchronized correctly with [Synchronize display] set to [On], the unit may not operate properly. Confirm the operation conditions of [Synchronize display]. (see page 76)
- If [Multi display settings] - [Multi screen display] is specified in the schedule data of "Content Management Software", the setting is switched to the specified multi screen display. The setting of [Multi screen display] cannot be changed during the specified schedule playback. When the specified schedule has finished, the setting of [Multi screen display] is restored to the state before setting.

■ Caption display

A caption is displayed at the time set for the schedule data.

Note

- The caption is displayed on top of an image.
 - A maximum of 600 characters can be displayed with caption.
 - Scrolling of the caption may stop at switching timing of content playback or music playback.
 - The caption is hidden by switching input. If the input is switched with the schedule playback function, the caption display continues.
- Also, if the schedule playback function is resumed, the caption is displayed from the beginning.
- Changing the settings of [OSD language], [Display orientation] or [Image rotation], or displaying the display ID/display name will delete the caption being displayed.
 - When creating schedule data, if a caption with many characters is displayed with [Scroll] set to [No], the characters will run over on the screen.
 - The caption does not synchronize with other displays even if [Play mode] is [Synchronize play].

■ Disabled functions

The following main unit's functions are set to [Disable (Off)] during schedule play mode.

- [Set up timer]
- [Screensaver]
- "Power management" function
- [No signal power off]
- [HDMI-CEC settings]
- [No activity power off]
- [OSD transparency]
- [Image settings] (Reading user image is disabled.)
- [Input search]
- [Initial input]
- [Input lock]
- [Failover/Failback]

Note

- Disabled functions are greyed out on the on-screen menu. Also, serial commands are in [ER401] state (Including the inquiry command).
- During schedule play mode, disabled functions are set to [Disable (Off)], and those operations are forcibly stopped.
- When schedule play mode has finished, the disabled functions are restored to the original setting values.
- For [Multi display settings] – [Multi screen display], only [Horizontal scale], [Vertical scale] and [Location] can be set. [Bezel H adjustment] and [Bezel V adjustment] cannot be set.
- [Multi display settings] – [Multi input display] cannot be set to [On] during schedule play mode. Also, [Schedule play function] cannot be set to [Enable] when [Multi display settings] – [Multi input display] is set to [On].

■ Resume play

Sets the operation when the schedule playback is restored again after schedule play mode is stopped once.

When set to [On]:

The previous content before schedule play mode is stopped is played back from the beginning.

When set to [Off]:

The playlist scheduled to be played back at the current time is played back from the beginning.

Note

- When playback is scheduled in the synchronized playback mode, the playback is performed according to the set time in both [On] and [Off] cases.

Using “Memory viewer”

The “Memory viewer” selects still pictures and motion pictures stored in a USB memory device, and show them on the display.

Preparation

■ The files you can display with the “Memory viewer”

The following files are supported.

Still pictures

| Extension | Format | Limitation |
|----------------------|----------------|--|
| jpg/ jpeg/ jpe | JPEG | Number of pixels: Minimum 32 x 32, Maximum 4 096 x 4 096 (supports baseline only) YUV format: supports YUV444, YUV442 and YUV440 Colour mode: supports RGB only |
| bmp | Windows Bitmap | Number of pixels: Minimum 32 x 32, Maximum 4 096 x 4 096 (1 bit, 4 bits, 8 bits, 24 bits) Following formats are not supported: Run-length encoding, bit field, top-down, transparent data If the number of pixels exceeds 1 920 x 1 080, a long time may be required to display content. |

Motion pictures

| Extension | Codec | Audio |
|-----------|--|------------------------------|
| | Video | |
| avi | H.264/MPEG4 AVC | AAC-LC/LPCM/MP/ WMA Standard |
| | MPEG4 Visual VC-1 Advanced VC-1 Simple & Main | |
| mkv | H.264/MPEG4 AVC | AAC-LC/HE-AAC/LPCM/ MP3 |
| | MPEG4 Visual VC-1 Advanced VC-1 Simple & Main H.265/HEVC | |

| | | |
|-----------------|--|--|
| wmv asf | H.264/MPEG4 AVC MPEG4 Visual VC-1 Advanced VC-1 Simple & Main | LPCM/MP3/ WMA Standard/WMA9/ WMA10 Pro |
| mp4/ mov/flv | H.264/MPEG4 AVC MPEG4 Visual H.265/HEVC | AAC-LC/HE-AAC/MP3 |
| ts/mts | H.264/MPEG4 AVC H.265/HEVC | AAC-LC/HE-AAC/LPCM/ MP3 |

Limitation

| Video | |
|--|---|
| Codec | Resolution |
| H.264/ MPEG4 AVC | 1 920 x 1 080p@60.0 3 840 x 2 160p@30.0 Bit rate: Maximum 80Mbps |
| MP@L5.1/ HP@L5.1 | <ul style="list-style-type: none"> MVC (Multi-view Video Coding) is not supported. |
| H.265 | 3 840 x 2 160p@60.0 |
| MP@L5.1/ MP10@L5.1 | 1 920 x 1 080p@60.0 Bit rate: Maximum 80Mbps <ul style="list-style-type: none"> Only 1 warp-point GMC supported Data Partitioning is not supported. |
| MPEG4 Visual | 1 920 x 1 080p@30.0 Bit rate: Maximum 40Mbps |
| SP@L5/ ASP@L5 | <ul style="list-style-type: none"> Video standard specified by MPEG4 Part2 |
| VC-1 Advanced | 1 920 x 1 080i@30.0 1 920 x 1 080p@24.0 Bit rate: Maximum 40Mbps |
| AP@L3 | |
| VC-1 Simple & Main | 1 920 x 1 080p@30.0 Bit rate: Maximum 40Mbps |
| SP@LL/SP@ ML/MP@LL/ MP@ML/ MP@HL | |

Audio

| Codec | Sampling frequency (kHz) | Bit rate (kbps) |
|-----------------------|--------------------------|--|
| MP3 | 8/11.025/12/16/ | 8 – 320 |
| WMA Standard | 22.05/24/32/44.1/ | 32 – 384 |
| WMA 9 | 48 | 32 – 384 |
| WMA 10 Pro | | 32 – 384 |
| LPCM | | 64 – 1 536 Supported quantization bit: 8/16/24/32 |
| AAC(LC) | | 8 – 1 440 |
| HE-AAC (Ver.2 Level4) | | 8 – 256 |

Music

| Extension | Codec | |
|-----------|---------------------------|--------------------------------|
| mp3 | MPEG-1/2 Audio Layer-3 | Sample rate: Maximum 48 kHz |
| | AAC(LC) | Channel: Maximum 2 ch |
| | HE-AAC (Ver.1) | Bit rate: Maximum 320kbps |
| wma | WMA | |

Note

- A maximum bit rate is the upper limit on the USB 3.0 memory, and depends on the performance of a USB memory device to be used.
- Some information for still image/movie files can be viewed with a computer where relevant files are accessible.
- About supported devices, refer to “Supported device”. (see page 112)
- Some files may not be played back even if they are supported formats described above.
- If the number of pixels of a file exceeds the screen size, the picture quality will change.

Operation example

-For Windows computer

1. Right-click a file, and click [Properties].
2. Click the [Details] tab.

-For Mac

1. Click a file while holding down the “Control” key, and click [Get Info].
 2. Click [More Info].
- The maximum size of file is 2 GB.
 - The maximum number of file/folder is up to 2 000. If the number exceeds, 2 000 files/folders are displayed.
 - You cannot play the files which are protected by Digital Rights Management (DRM).
 - If files or folders include characters other than one-byte alphanumeric characters, they may not be displayed correctly, or the playback may not be done properly.
It is recommended to use only one-byte alphanumeric characters for files and folders.
 - Thumbnails of files may not be correctly displayed even if they are playable.
 - If the file name including the file path (folder information) and extension has 248 one-byte alphanumeric characters or more, the thumbnail is not displayed. (see page 124)
 - When playing back in series several kinds of content with different aspect ratios, the image may be distorted momentarily when switching content.
It is recommended to unify the aspect ratio for consecutive playback.
 - Depending on the type of motion picture, the images may be distorted momentarily during playback or thumbnail display.

Displaying the “Memory viewer” screen

Press <INPUT> to switch the input to [MEMORY VIEWER].

Assigning [Input] function to the numeric buttons (<1> to <6>) can switch to [MEMORY VIEWER] with a single touch of a button. (see page 83)

The thumbnails or the file list is displayed.

You can switch the display between the thumbnail view and file list view by setting [Setup] - [Memory viewer settings]. (see page 83)

Note

- Use the remote control to operate “Memory viewer”.

Thumbnail view

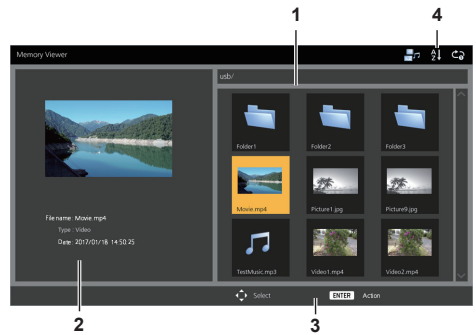

1. Thumbnails

Displays folders, pictures, videos and music files.
The following icons will be displayed.

- Moves to the upper level when selected.
- Moves to the lower level when selected.
- Picture file.
- Video file.
- Music file.
- The file has a supported extension but cannot be played.

In the thumbnail view, if images for thumbnails can be displayed, icons are replaced with automatically created thumbnail images.

Note

- If the image includes Exif information, orientations of the thumbnail image and the playback image may differ.

2. Information of the selected file.

3. Remote control operation guide

4. Status indicator icon

Displays the type of content, display order and playback method with icons.

Type of content

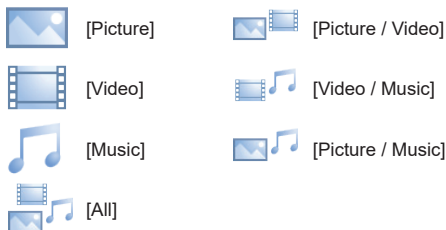

Display order

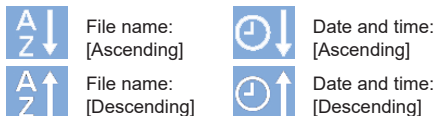

Play method

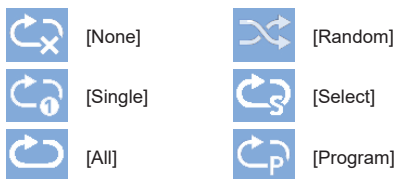

■ File list view

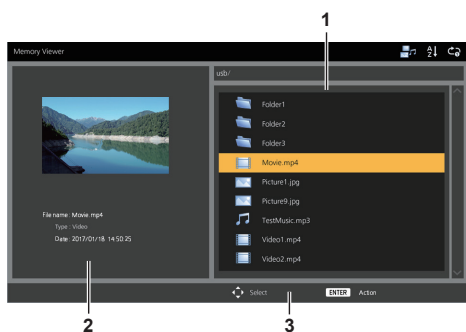

1. File list

Displays folders, pictures, videos and music files.

2. Displays information of the selected file.

3. Remote control operation guide

Playing the pictures

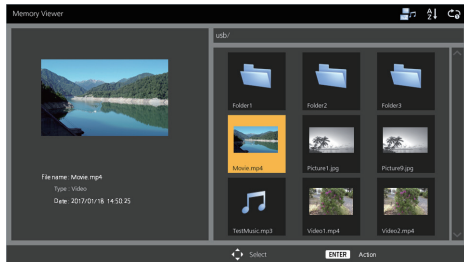

Select a file in the same manner in the file list view.

1 In the thumbnail view / the file list view, press ▲ ▼ ◀ ▶ to select the file you want to play.

Note

- When [Play method] is [Select] or [Program], press <VOL +> <VOL -> to specify the file you want to play. (see page 83)

File selection is cancelled by the following operations.

- Folder movement
- [Play method] change
- Removal of USB memory device
- Input switch
- Power-off

2 Press <ENTER>.

The picture will be displayed on the full screen.



1. Remote control operation guide

Press the remote control buttons to perform the following operations.

◀ : Skip to the previous file.

▶ : Skip to the next file.

▲ : Rotate the picture clockwise (90°).

▼ : Rotate the picture counterclockwise (90°).

<ENTER> : Pause / Restart playing.

<RETURN> : Return to the list view.

<1> : Not used

<2> : Display / Hide the detail of the content that is being played back.

- <3> : Not used
- <4> : Not used
- <5> : Display / Hide the remote control operation guide.
- <6> : Not used

Pressing <ENTER> during play stops the play temporarily. Press it again to restart the play.

Pressing ◀ during play starts the play from the previous picture and pressing ▶ from the next picture.

It is possible to set play interval in [Setup] - [Memory viewer settings]. (see page 83)

3 Press <RETURN>.

Returns to the thumbnail view or file list view.

Playing the video / music

1 Select the file you want to play in the same manner as “Playing the pictures”. (see page 125)

2 Press <ENTER>.

The video will be displayed on the full screen.

Note

- The music icon is displayed on the screen for music playback.

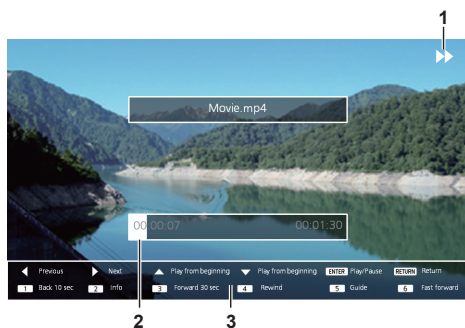

1. Fast forward / Rewind / Pause indication

- ▶ Normal play
- ⏸ Pause
- ▶▶ Fast forward (first stage)
- ▶▶▶ Fast forward (second stage)
- ◀◀ Rewind (first stage)
- ◀◀◀ Rewind (second stage)

2. Time bar

3. Remote control operation guide

Press the remote control buttons to perform the following operations.

Pressing <4> during play will rewind and <6> will fast forward the video. The speed changes in 2 steps each time you press the button, and returns to the normal play.

- ◀ : Skip to the previous file.
- ▶ : Skip to the next file.
- ▲ : Play from the beginning. (Plays the current file from the beginning.)
- ▼ : Play from the beginning. (Plays the current file from the beginning.)

<ENTER> : Pause / Restart playing.

<RETURN> : Return to the list view.

<1> : Skip 10 seconds backward.

<2> : Display / Hide the detail of the content that is being played back.

<3> : Skip 30 seconds forward.

<4> : Rewind.

<5> : Display / Hide the remote control operation guide.

<6> : Fast forward.

Note

- Depending on the content to be played, “Skip 10 seconds backward” or “Skip 30 seconds forward” may not operate correctly.

3 Press <RETURN>.

Returns to the thumbnail view or file list view.

■ Disabled functions

While using the “Memory viewer”, the following main unit’s functions are disabled.

- [Read user image] in [Image settings]
- Multi screen display of the multi display
- [Digital zoom]
- [No signal power off]
- [Position]
- [Function button settings]
(Disabled while content is being played)

Note

- To prevent image retention on the liquid crystal panel, using the screensaver function is recommended. (see page 67)

Using HDMI-CEC function

The HDMI-CEC function enables the remote control of this unit alone to operate the basics of HDMI-CEC compatible devices by the interlocking control between this unit and such devices. Also, this function enables the remote control (or main unit's buttons) of a HDMI-CEC compatible device alone to turn on/off this unit and switch input.

Connection

Connect the HDMI-CEC compatible device to the HDMI 1, HDMI 2 or SLOT terminal.

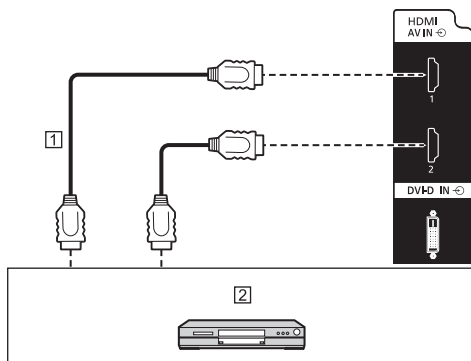

1 HDMI cable (commercially available)

2 DVD Recorder / DVD Player, Blu-ray Recorder / Blu-ray Player

Setting

- 1 Make the setting on the connected device (HDMI-CEC compatible device) so this function can operate.
- 2 Set [HDMI-CEC settings] - [HDMI-CEC control] to [Enable]. (see page 72)
- 3 Turn on all the devices, and turn this unit off and on. Then check if images can be seen correctly with HDMI1, HDMI2 or SLOT input.

Interlocking devices

Performs the following interlocking operations by setting each item of [Link function] for [HDMI-CEC settings].

■ [Display → Device] interlocking

- **When set to [Power off] or [Power off / on]:**
Turning this unit off turns off all the connected HDMI-CEC compatible devices.
- **When set to [Power off / on]:**
Turning this unit on through the HDMI-CEC compatible device connected to [HDMI1], [HDMI2] or [SLOT] when the input is [HDMI1], [HDMI2] or [SLOT].
- Switching the input of this unit to HDMI1, HDMI2 or SLOT turns on the connected HDMI-CEC compatible device.

Note

- When multiple devices are connected with the [HDMI1], [HDMI2] or [SLOT] input and this unit is turned on with the [Power off / on] setting, the device that was viewed or listened last is turned on.
- When this unit is turned on with the [Power off / on] setting and the device that was viewed or listened last with the [HDMI1], [HDMI2] or [SLOT] input is not connected, a device displayed for [HDMI1], [HDMI2] or [SLOT] of [HDMI-CEC settings] is turned on.

■ [Device → Display] interlocking

When set to [Power on] or [Power off / on]:

- Turning on the HDMI-CEC compatible device turns this unit on, and switches the input to HDMI1, HDMI2 or SLOT to which the device is connected.
- Starting to play back on the HDMI-CEC compatible device turns this unit on, and switches the input to HDMI1, HDMI2 or SLOT to which the device is connected.
- Starting to play back on the HDMI-CEC compatible device switches the input of this unit to HDMI1, HDMI2 or SLOT to which the device is connected.

When set to [Power off / on]:

- Turning off the HDMI-CEC compatible device of input (HDMI1 / HDMI2 / SLOT) with which you are currently viewing or listening turns off this unit.

Note

- The device interlocking function, which turns off this unit, realizes the interlocking operations by monitoring signal statuses of devices.

Depending on the setting, the device continues to output signals even in the power-off state. In this case, the interlocking function does not operate.

In this case, refer to the manuals of the devices.

- Input will not be switched when [Setup] - [Input lock] is set.
- Depending on the display status or video equipment status, such as during start-up, the interlocking operation may not be performed.
- When the function board is inserted to SLOT and [DVI-D/SLOT select] is set to [DVI-D], the input is not switched to SLOT input.

Operating a device (using the remote control of this unit)

Display the operation screen in [Setup] - [HDMI-CEC settings] - [HDMI-CEC operation].

Operation screen

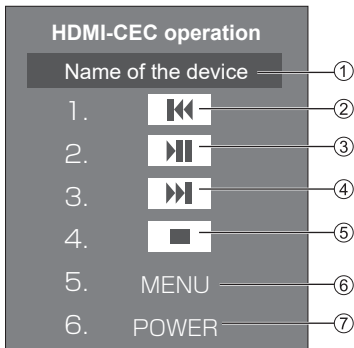

- ① Displays the name of the device to operate.
- ② Plays from the position where programs or scenes are skipped backward by the number of pressed times.
- ③ Play/Pause (Toggle operation)
- ④ Plays from the position where programs or scenes are skipped forward by the number of pressed times.
- ⑤ Stop
- ⑥ Displays the setting menu of the device.
([MENU code] (see page 72))
- ⑦ Controls the power of the device.

Note

- It is possible to operate HDMI-CEC compatible device with the numeric buttons <1> to <6>.

Menu operation of HDMI-CEC compatible devices

When the setting menu of the HDMI-CEC compatible device is displayed, it is possible to operate the menu with the remote control of this unit (<ENTER>, ▼▲◀▶, <RETURN>).

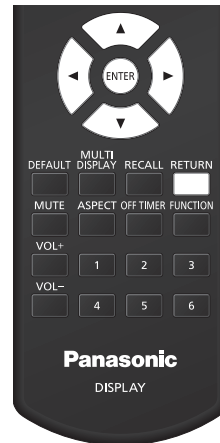

Note

- It is not possible to operate the menu of the HDMI-CEC compatible device in the following condition.
 - When the menu ([Setup] / [Picture] / [Sound] / [Position]) or submenu of this unit is displayed

Using multi input display function of the multi display

Displays images input from multiple devices on one display simultaneously.

Note

- The display example of multi input shows [4 input display]. [Picture in picture] and [Picture by picture] can also be switched.
- Set [Multi display settings] - [Screen type] to [Multi input display]. (see page 55)

Displaying 4 screens

MENU operation

1 During the 1-screen display, set [Multi input display] for [Multi display settings] to [On]. (see page 55)

Switching between [Off] and [On] each time will switch between the 1-screen display and the 4-screen display.

Remote control operation

1 During the 1-screen display, press [MULTI DISPLAY].

Pressing the button each time will switch between the 1-screen display and the 4-screen display.

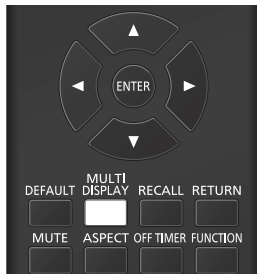

1-screen display



4-screen display

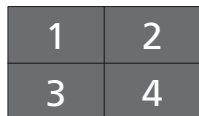

Switching 4 screens to 1 screen

During the 4-screen display, select a screen to be displayed with 1-screen.

1 Press <INPUT> during the 4-screen display to display the selection menu.

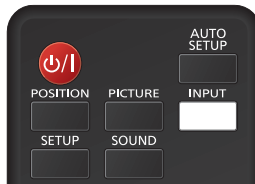

Selection menu display

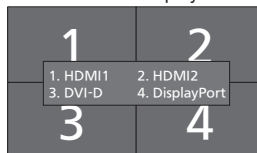

2 Press the number of the screen for the 1-screen display on the numeric button. Then the selected screen is displayed.



Note

- In the case of [Picture in picture] and [Picture by picture], screen switching in addition to screen selection is also possible.

Disabled functions

The following main unit's functions are set to [Disable (Off)] during multi input display of the multi display.

- [Position]
- Aspect mode (ASPECT)
- "Power management" function
- [Input search]
- [Failover/Failback]
- [HDMI-CEC settings]
- [Playlist edit] function

Using data cloning

Menu settings and adjusted values of a single display can be copied to multiple displays by using a USB memory or via LAN.

Note

- If the sizes of the displays are different, the cloning function does not operate. Use the common sized displays.
- Set the input to something other than [USB] or [MEMORY VIEWER], and perform the data cloning.
- The cloning password is the one set for [Cloning password].
- The initial password in the factory default state is [AAAA].
- The remote control is necessary to operate [LAN data cloning].

■ Data that can be copied

Settings and set values of [Picture], [Sound], [Setup] and [Position] menus

User image registered in [Setup] - [Image settings]

The following contents of the [Detailed set up] page on the Web control screen

[Status notification set up]

- The following data cannot be copied. Setting is required for each display.

[Cloning password]

[Date and time]

[Network settings] - [Display name]

Setting for [Network settings] - [LAN setup]

[Synchronize display setting]

[Time zone]

[NTP synchronization]

NTP server name

DNS server

[Control settings] in [Display ID]

The setting contents of the [Change password] page on the Web control screen

The following contents of the [Detailed set up] page on the Web control screen

[Network config]

[Adjust clock]

[Command port set up]

The setting contents of the [Crestron Connected] page on the Web control screen

■ Supported device

- Commercially available USB memory devices are supported. (Those with security functions are not supported.)
- USB memory devices other than those formatted in FAT16 or FAT32 cannot be used.
- Up to 32 GB of USB memory in size are supported.
- Only single partition configuration is supported.

Copying the display data to the USB memory

- 1 Insert the USB memory device to the USB terminal on the bottom of the display.**

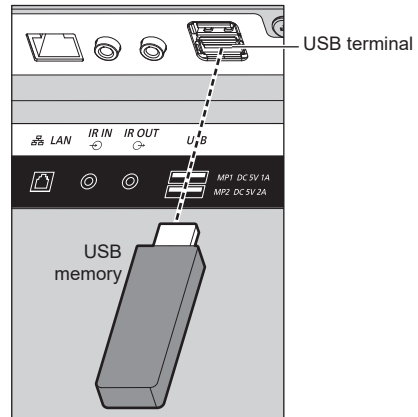

Note

- Depending on the type of a USB memory device, it may come in contact with the periphery such as a back cover, and cannot be attached. Use a USB memory device connectable to this unit.
- Failure to save in or read from the USB memory device displays an error message.

- 2 After the [Cloning password] screen is displayed, go to the step 6.**

When the [Cloning password] screen is not displayed, follow the steps 3 to 5 to display.

- 3 Display [Setup] menu pressing <SETUP>.**

- 4 Select [Options] with ▲ ▼ and press <ENTER>.**

The following display appears.

| |
|---------------------|
| Display information |
| Software licenses |
| Cloning password |
| USB data cloning |
| LAN data cloning |
| Output log data |
| Shipping |

- 5 Select [USB data cloning] with ▲ ▼ and press <ENTER>.**

[Cloning password] screen is displayed.

- 6 Enter the cloning password, and then press <ENTER>.**

Data cloning screen is displayed.

7 Select [Display → USB memory] with ▲ ▼ and press <ENTER>.



8 Select [Yes] with ◀ ▶ and press <ENTER>.

Data copy to the USB memory starts.

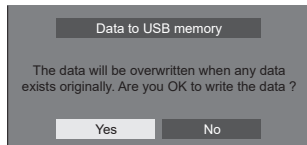

The following message is displayed after data copy has finished.

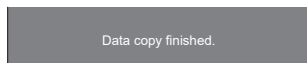

9 After data copy has finished, remove the USB memory device from the USB terminal.

Copying (cloning) the USB memory data to the display

1 Insert the USB memory device, which the data has been copied, to the USB terminal of the display for data copy (same as the step 1 on page 130).

2 After the [Cloning password] screen is displayed, go to the step 6.

When the [Cloning password] screen is not displayed, follow the steps 3 to 5 to display.

Note

- If the USB memory containing the data for cloning is connected in power-on state, the [Cloning password] screen is displayed.

3 Display [Setup] menu pressing <SETUP>.

4 Select [Options] with ▲ ▼ and press <ENTER>.

The following display appears.

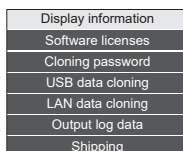

5 Select [USB data cloning] with ▲ ▼ and press <ENTER>.

[Cloning password] screen is displayed.

6 Enter the cloning password, and then press <ENTER>.

Data cloning screen is displayed.

7 Select [USB memory → Display] with ▲ ▼ and press <ENTER>.

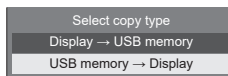

8 Select [Yes] with ◀ ▶ and press <ENTER>.

Data cloning to the display starts.

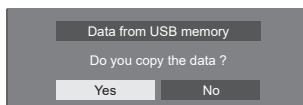

The following message is displayed after data cloning has finished.

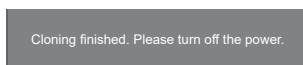

9 After data cloning has finished, remove the USB memory device from the USB terminal.

10 Press the power button on the remote control to turn the power off, and then turn the power on. Or remove the power plug from the outlet once, wait for 30 seconds or more, and then insert the power plug.

The cloned content is applied to the display.

- When USB memory is not removed in the step 9, the message [Select copy type] is displayed when the display is turned on again.

Note

- When the data is copied with [POWER button lock] set to [On]

If the power is turned off using the power button of the main unit in step 10, the power button of the main unit is locked, and the power cannot be turned on again. In this case, remove the power plug, wait for 30 seconds or more, then connect the power plug again, and wait for a few minutes. Power indicator: Lights up in red (standby). Turn the power on using the remote control, and set [POWER button lock] to [Off]. Then, turn the power off using the power button of the main unit, and turn the power on again.

Copying data to other display via LAN

- 1 Display [Setup] menu pressing <SETUP>.
- 2 Select [Options] with ▲▼ and press <ENTER>.

The following display appears.

| |
|---------------------|
| Display information |
| Software licenses |
| Cloning password |
| USB data cloning |
| LAN data cloning |
| Output log data |
| Shipping |

- 3 Select [LAN data cloning] with ▲▼ and press <ENTER>.

[Cloning password] screen is displayed.

- 4 Enter the cloning password, and then press <ENTER>.

[LAN data cloning] screen is displayed.

- 5 Select [Select display] with ▲▼ and press <ENTER>.

Displays on the same subnet are listed.

| LAN data cloning | | |
|------------------|--------------|------------|
| Execute | | |
| Select display | | |
| Write protect | Off | |
| Status | Display name | IP address |
| | | |

- 6 Select the display to copy the data to with ▲▼ and press <VOL +>.

Select all the displays to copy the data to.

| Select display | | | |
|---------------------------------------|--------------|---------------|---|
| Please check the display to register. | | | |
| Check | Display name | IP address | |
| <input checked="" type="checkbox"/> | SQ1-001 | 192.168.0.1 | 1 |
| <input checked="" type="checkbox"/> | SQ1-002 | 192.168.0.2 | 2 |
| <input type="checkbox"/> | SQ1-004 | 192.168.0.4 | 4 |
| <input type="checkbox"/> | SQ1-005 | 192.168.0.25 | |
| <input type="checkbox"/> | SQ1-014 | 192.168.0.31 | |
| <input type="checkbox"/> | SQ1-006 | 192.168.0.7 | |
| <input type="checkbox"/> | SQ1-041 | 192.168.0.124 | |
| <input type="checkbox"/> | SQ1-009 | 192.168.0.211 | |

- 7 Press <ENTER>.

8 Select [Execute] with ▲▼ and press <ENTER>.

LAN data cloning

Execute

Select display

Write protect Off

| Status | Display name | IP address |
|--------|--------------|---------------|
| ☑ | S01-001 | 192.168.0.1 |
| ☑ | S01-002 | 192.168.0.2 |
| ☑ | S01-004 | 192.168.0.4 |
| ☑ | S01-005 | 192.168.0.25 |
| ☑ | S01-014 | 192.168.0.31 |
| ☑ | S01-006 | 192.168.0.7 |
| ☑ | S01-041 | 192.168.0.124 |
| ☑ | S01-009 | 192.168.0.211 |

Note

- Data cannot be copied to the display for which [Write protect] is set to [On]. Set this to [On] to prevent [LAN data cloning] from being performed mistakenly when data copy is not necessary.
- Once [LAN data cloning] is performed, [Write protect] is set to [On].

9 A confirmation window appears.

Select [Execute] with ◀▶ and press <ENTER>.

LAN data cloning

All data for the selected displays will be changed.
Are you sure you want to execute?

Execute Return

Data copy to the display starts.

LAN data cloning

DO NOT unplug your Display!
Cloning in progress, please wait.

10 The exit screen appears.

The green mark on the list shows the data has been copied successfully. The red mark shows failure. If the red mark appears, check the LAN cable connection or power status of the display of the copy destination.

LAN data cloning

Cloning finished.

| Status | Display name | IP address |
|--------|--------------|---------------|
| ● | S01-001 | 192.168.0.1 |
| ● | S01-002 | 192.168.0.2 |
| ● | S01-004 | 192.168.0.4 |
| × | S01-005 | 192.168.0.25 |
| ● | S01-014 | 192.168.0.31 |
| ● | S01-006 | 192.168.0.7 |
| ● | S01-041 | 192.168.0.124 |
| ● | S01-009 | 192.168.0.211 |

If the data copy has finished, the message appears on the display of the copy destination.

Cloning finished. Please turn off the power.

11 Press the power button on the remote control to turn the power off, and then turn the power on. Or remove the power plug from the outlet once, wait for 30 seconds or more, and then insert the power plug.

The copied content is applied to the display.

Note

- When the data is copied with [POWER button lock] set to [On]

If the power is turned off using the power button of the main unit in step 11, the power button of the main unit is locked, and the power cannot be turned on again. In this case, remove the power plug, wait for 30 seconds or more, then connect the power plug again, and wait for a few minutes. Power indicator: Lights up in red (standby). Turn the power on using the remote control, and set [POWER button lock] to [Off]. Then, turn the power off using the power button of the main unit, and turn the power on again.

Changing the cloning password

Changes the cloning password required to use the cloning function.

1 Insert the USB memory device to the USB terminal on the bottom of the display.

The password input screen is displayed.

2 Enter the current password, and press [OK].

3 Enter the new password, and press [OK].

4 Enter the new password AGAIN for confirmation, and press [OK].

Note

- The initial password in the factory default state is [AAAA].
- Change the password periodically, and set one which is difficult to guess.
- For initialization method for the cloning password, consult the dealer where you purchased the product.

USB memory network settings

Using a USB memory device, the network setting can be made for multiple displays.

■ About the setting

The following items in [Network settings] - [LAN setup] can be set.

[IP address], [Subnet mask], [Gateway], [Command port], [EAP]

Note

- [Network settings] - [LAN setup] - [DHCP] is set to [Off].
- [Network settings] - [Network control] is set to [On].
- Make sure that [Network settings] - [USB memory network settings] is set to [Permit].
If it is set to [Prohibit], network setting cannot be made with this function. (see page 81)
- Once the network setting is done with USB memory device, [Network settings] - [USB memory network settings] is set to [Prohibit].
- For 98 and 86 inch models, [EAP] is set only when the main software version is 4.0000 or later.

■ Supported device

- Commercially available USB memory devices are supported. (Those with security functions are not supported. Operation is not guaranteed.)
- USB memory devices other than those formatted in FAT16 or FAT32 cannot be used.
- Up to 32 GB of USB memory in size are supported.
- Only single partition configuration is supported.
- Use a writable USB memory device.

Saving the LAN setting file to the USB memory device

Create the following files, and save them to the USB memory device.

File name: th-65sq1_network.sh

Setting Example

```
TH-65SQ1_LAN_SETTINGS
A:192.168.0.18
S:255.255.255.0
G:192.168.0.1
P:1024
I:ON
E:EAP-TLS
E_U:EAPUSER
E_P:eappassword
E_D:digitalcertificate.pdf
E_C:cacertificate.cer
```

TH-65SQ1_LAN_SETTINGS:

Fixed characters represent the model name. Be sure to input as follows.

TH-(inch size)(Model name)_LAN_SETTINGS

A: Specifies the IP address.

S: Specifies the subnet mask.

G: Specifies the gateway address.

P: Specifies the port number to use for the command control.

I: Setting this to [ON] can set individual IP addresses for each main unit.

One IP address is assigned to each main unit in the range that can be specified as an IP address.

E: Selects the EAP setting. Describe the setting referring to the following.

- NONE
- PEAP(MS-CHAPv2)
- PEAP(GTC)
- EAP-TTLS(MD5)
- EAP-TTLS(MS-CHAPv2)
- EAP-FAST(MS-CHAPv2)
- EAP-FAST(GTC)
- EAP-TLS

E_U: Specifies the EAP user name. This is referred to only when EAP is set to something other than [NONE].

E_P: Specifies the EAP password. This is referred to only when EAP is set to something other than [NONE].

E_D: Describe the file name of the electronic certificate (extension: PFX) used for authentication. This is referred to only when EAP is set to [EAP-TLS].

E_C: Describe the file name of the CA certificate (extension: CER) used for authentication. This is referred to only when EAP is set to [EAP-TLS].

Note

- Deleting the rows "S", "G", "P" or "E" will not overwrite the deleted setting items. The original setting contents are retained.
- When the row "I" is deleted, it will be set to [ON] automatically.
- Be sure to fill in the rows of the fixed character and IP address.
- If the network setting fails with this function, an error message is displayed.
If fails, the network setting is not changed.
Be sure to confirm the file description, and insert the USB memory device again.
- This function operates only when a file with the above file name exists in the USB memory device.
- Use one-byte alphanumeric characters to describe file contents.
- For 98 and 86 inch models, settings of E, E_U, E_P, E_D and E_C lines are set only when the main software version is 4.0000 or later.

Copying the USB memory data to the display

- 1 Insert the USB memory device to the USB terminal on the bottom of the display.

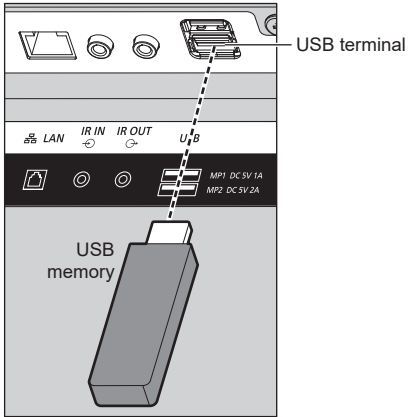

- 2 The [LAN setup] screen is displayed after data copy has finished.
- 3 Remove the USB memory device from the USB terminal.

ID Remote Control Function

You can set the remote control ID when you want to use this remote control on one of several different displays. In that case, you need to set the remote control's ID number to match the Display's ID number you have set in [Control settings] - [Display ID] following the steps below.

Note

- To operate this function, please purchase ID remote controller sold separately.
Object model: N2QAYA000093



Setting the remote control's ID number

- 1 Set [Control settings] - [Controller ID function] to [On].
(see page 87)
- 2 Set the remote control's <ID MODE> switch to <ON>.
- 3 Pointing the remote control at the Display you want to control, press <ID SET>.

| ID set | |
|---------------|---|
| Display ID | 0 |
| Controller ID | ? |

- 4 Press one of <0> – <9>.
Sets the tens digit.
- 5 Press one of <0> – <9>.

Sets the units digit.

- The steps from 3 to 5 need to be done within 5 seconds.
- Adjustable ID number range is 0 – 100.

Example:

- To set the ID to "1": After step 3, press <0> and then <1>.
- To set the ID to "12": After step 3, press <1> and then <2>.
- To set the ID to "100": After step 3, press <1> <0> <0>.

Cancelling the setting of remote control's ID number (ID "0")

You can operate even if the ID does not match the ID set in [Control settings] - [Display ID].

Press <ID SET> for more than 3 seconds.

This has the same effect as pressing <ID SET> <0> <0>.

Entering characters

Some settings require to enter characters.

To enter text, select characters in the on-screen keyboard.

Example: Entering profile names ([Memory save])



The default profile name is [MEMORY1], here, we are changing it to [MY PICTURE] as an example.

1 Select [All delete] with ▲▼◀▶, and press <ENTER>.

MEMORY1

All text is deleted.

To delete individual characters, select [Delete].

2 Select [a / A / @] with ▲▼◀▶, and press <ENTER>.



Switches the keyboard to the upper case alphabet.

Each time <ENTER> is pressed, the keyboard is switched in the order of lower case, upper case and symbols.

3 Select [M] with ▲▼◀▶, and press <ENTER>.

M

Repeat this process to enter the next character.

4 Select Space key with ▲▼◀▶, and press <ENTER>.

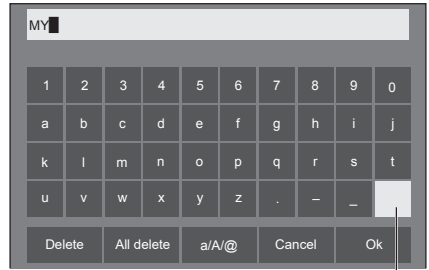

Space key

As shown in step 3, select the characters to enter [PICTURE].

5 When you finished entering the profile name, select [Ok] with ▲▼◀▶ and press <ENTER>.

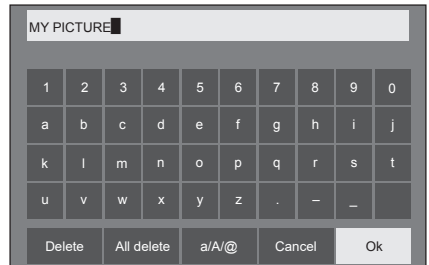

- To cancel saving the profile, select [Cancel].

Preset Signals

This unit can display the video signals shown in the table below.

- The contents of HDMI signal in the Plug and Play-supported signal column are as follows.

EDID1: 4K/60p (HDR), EDID2: 4K/60p (SDR), EDID3: 4K/30p, EDID4: 2K

| Corresponding signal | Resolution (Dot) | Scanning frequency | | Dot clock frequency (MHz) | Format**2 | Plug and Play-supported signal*5 | | | | | | |
|----------------------|----------------------|--------------------|---------------|---------------------------|-------------|----------------------------------|--------|--------|--------|----|----|----------|
| | | Horizontal (kHz) | Vertical (Hz) | | | HDMI | | | | DL | DP | DVI-D/PC |
| | | | | | | EDID 1 | EDID 2 | EDID 3 | EDID 4 | | | |
| 480/60i | 720 x 480i | 15.73 | 59.94 | 13.50 | Y | — | — | — | — | — | — | — |
| 480/60i | 720 (1 440) x 480i*1 | 15.73 | 59.94 | 27.00 | D/H/DL | ○ | ○ | ○ | ○ | ○ | — | — |
| 576/50i | 720 (1 440) x 576i*1 | 15.63 | 50.00 | 27.00 | D/H/DL | ○ | ○ | ○ | ○ | ○ | — | — |
| 480/60p | 720 x 483 | 31.47 | 59.94 | 27.00 | Y/D/H/DL/DP | ○ | ○ | ○ | ○ | ○ | ○ | — |
| 576/50p | 720 x 576 | 31.25 | 50.00 | 27.00 | Y/D/H/DL/DP | ○ | ○ | ○ | ○ | ○ | ○ | — |
| 720/60p | 1 280 x 720 | 45.00 | 60.00 | 74.25 | Y/D/H/DL/DP | ○ | ○ | ○ | ○ | ○ | ○ | — |
| 720/50p | 1 280 x 720 | 37.50 | 50.00 | 74.25 | Y/D/H/DL/DP | ○ | ○ | ○ | ○ | ○ | ○ | — |
| 1080/60i | 1 920 x 1 080i | 33.75 | 60.00 | 74.25 | Y/D/H/DL/DP | ○ | ○ | ○ | ○ | ○ | ○ | — |
| 1080/50i | 1 920 x 1 080i | 28.13 | 50.00 | 74.25 | Y/D/H/DL/DP | ○ | ○ | ○ | ○ | ○ | ○ | — |
| 1080/24p | 1 920 x 1 080 | 27.00 | 24.00 | 74.25 | Y/D/H/DL/DP | ○ | ○ | ○ | ○ | ○ | ○ | — |
| 1080/24PsF | 1 920 x 1 080i | 27.00 | 48.00 | 74.25 | D/H/DL/DP | — | — | — | — | — | — | — |
| 1080/25p | 1 920 x 1 080 | 28.13 | 25.00 | 74.25 | Y/D/H/DL/DP | ○ | ○ | ○ | ○ | ○ | ○ | — |
| 1080/30p | 1 920 x 1 080 | 33.75 | 30.00 | 74.25 | Y/D/H/DL/DP | ○ | ○ | ○ | ○ | ○ | ○ | — |
| 1080/60p | 1 920 x 1 080 | 67.50 | 60.00 | 148.50 | Y/D/H/DL/DP | ○ | ○ | ○ | ○ | ○ | ○ | — |
| 1080/50p | 1 920 x 1 080 | 56.25 | 50.00 | 148.50 | Y/D/H/DL/DP | ○ | ○ | ○ | ○ | ○ | ○ | — |
| 2K/24p | 2 048 x 1 080 | 27.00 | 24.00 | 74.25 | D/H/DL/DP | — | — | — | — | — | — | — |
| 2K/25p | 2 048 x 1 080 | 28.13 | 25.00 | 74.25 | D/H/DL/DP | — | — | — | — | — | — | — |
| 2K/30p | 2 048 x 1 080 | 33.75 | 30.00 | 74.25 | D/H/DL/DP | — | — | — | — | — | — | — |
| 2K/48p | 2 048 x 1 080 | 54.00 | 48.00 | 148.50 | D/H/DL/DP | — | — | — | — | — | — | — |
| 2K/60p | 2 048 x 1 080 | 67.50 | 60.00 | 148.50 | D/H/DL/DP | — | — | — | — | — | — | — |
| 2K/50p | 2 048 x 1 080 | 56.25 | 50.00 | 148.50 | D/H/DL/DP | — | — | — | — | — | — | — |
| 3840 x 2160/24p | 3 840 x 2 160 | 54.00 | 24.00 | 297.00 | H/DL/DP | ○ | ○ | ○ | — | ○ | ○ | — |
| 3840 x 2160/25p | 3 840 x 2 160 | 56.25 | 25.00 | 297.00 | H/DL/DP | ○ | ○ | ○ | — | ○ | ○ | — |
| 3840 x 2160/30p | 3 840 x 2 160 | 67.50 | 30.00 | 297.00 | H/DL/DP | ○ | ○ | ○ | — | ○ | ○ | — |
| 3840 x 2160/60p | 3 840 x 2 160 | 135.00 | 60.00 | 594.00 | H/DL*4/DP | ○ | ○ | — | — | — | ○ | — |
| 3840 x 2160/50p | 3 840 x 2 160 | 112.50 | 50.00 | 594.00 | H/DL*4/DP | ○ | ○ | — | — | — | ○ | — |
| 4096 x 2160/24p | 4 096 x 2 160 | 54.00 | 24.00 | 297.00 | H/DL/DP | ○ | ○ | ○ | — | ○ | ○ | — |
| 4096 x 2160/25p | 4 096 x 2 160 | 56.25 | 25.00 | 297.00 | H/DL/DP | ○ | ○ | ○ | — | ○ | ○ | — |
| 4096 x 2160/30p | 4 096 x 2 160 | 67.50 | 30.00 | 297.00 | H/DL/DP | ○ | ○ | ○ | — | ○ | ○ | — |
| 4096 x 2160/60p | 4 096 x 2 160 | 135.00 | 60.00 | 594.00 | H/DL*4/DP | ○ | ○ | — | — | — | ○ | — |
| 4096 x 2160/50p | 4 096 x 2 160 | 112.50 | 50.00 | 594.00 | H/DL*4/DP | ○ | ○ | — | — | — | ○ | — |
| 640 x 400/70 | 640 x 400 | 31.47 | 70.09 | 25.18 | R/D/H/DL/DP | — | — | — | — | — | — | — |
| 640 x 400/85 | 640 x 400 | 37.86 | 85.08 | 31.50 | R/D/H/DL/DP | — | — | — | — | — | — | — |
| 640 x 480/60 | 640 x 480 | 31.47 | 59.94 | 25.18 | R/D/H/DL/DP | ○ | ○ | ○ | ○ | ○ | ○ | ○ |
| 640 x 480/67 | 640 x 480 | 35.00 | 66.67 | 30.24 | R/D/H/DL/DP | — | — | — | — | — | — | — |
| 640 x 480/73 | 640 x 480 | 37.86 | 72.81 | 31.50 | R/D/H/DL/DP | — | — | — | — | — | — | — |
| 640 x 480/75 | 640 x 480 | 37.50 | 75.00 | 31.50 | R/D/H/DL/DP | — | — | — | — | — | — | — |
| 640 x 480/85 | 640 x 480 | 43.27 | 85.01 | 36.00 | R/D/H/DL/DP | — | — | — | — | — | — | — |
| 800 x 600/56 | 800 x 600 | 35.16 | 56.25 | 36.00 | R/D/H/DL/DP | — | — | — | — | — | — | — |
| 800 x 600/60 | 800 x 600 | 37.88 | 60.32 | 40.00 | R/D/H/DL/DP | ○ | ○ | ○ | ○ | ○ | ○ | ○ |

| Corresponding signal | Resolution (Dot) | Scanning frequency | | Dot clock frequency (MHz) | Format*2 | Plug and Play-supported signal*5 | | | | | | |
|----------------------|------------------|--------------------|---------------|---------------------------|-------------|----------------------------------|--------|--------|--------|----|----|----------|
| | | Horizontal (kHz) | Vertical (Hz) | | | HDMI | | | | DL | DP | DVI-D/PC |
| | | | | | | EDID 1 | EDID 2 | EDID 3 | EDID 4 | | | |
| 800 x 600/72 | 800 x 600 | 48.08 | 72.19 | 50.00 | R/D/H/DL/DP | — | — | — | — | — | — | — |
| 800 x 600/75 | 800 x 600 | 46.88 | 75.00 | 49.50 | R/D/H/DL/DP | — | — | — | — | — | — | — |
| 800 x 600/85 | 800 x 600 | 53.67 | 85.06 | 56.25 | R/D/H/DL/DP | — | — | — | — | — | — | — |
| 832 x 624/75 | 832 x 624 | 49.72 | 74.55 | 57.28 | R/D/H/DL/DP | — | — | — | — | — | — | — |
| 852 x 480/60 | 852 x 480 | 31.47 | 59.94 | 34.24 | D/H/DL/DP | — | — | — | — | — | — | — |
| 1024 x 768/50 | 1 024 x 768 | 39.55 | 50.00 | 51.89 | D/H/DL/DP | — | — | — | — | — | — | — |
| 1024 x 768/60 | 1 024 x 768 | 48.36 | 60.00 | 65.00 | R/D/H/DL/DP | ○ | ○ | ○ | ○ | ○ | ○ | ○ |
| 1024 x 768/70 | 1 024 x 768 | 56.48 | 70.07 | 75.00 | R/D/H/DL/DP | — | — | — | — | — | — | — |
| 1024 x 768/75 | 1 024 x 768 | 60.02 | 75.03 | 78.75 | R/D/H/DL/DP | — | — | — | — | — | — | — |
| 1024 x 768/82 | 1 024 x 768 | 65.55 | 81.63 | 86.00 | R/D/H/DL/DP | — | — | — | — | — | — | — |
| 1024 x 768/85 | 1 024 x 768 | 68.68 | 85.00 | 94.50 | R/D/H/DL/DP | — | — | — | — | — | — | — |
| 1066 x 600/60 | 1 066 x 600 | 37.64 | 59.94 | 53.00 | D/H/DL/DP | — | — | — | — | — | — | — |
| 1152 x 864/60 | 1 152 x 864 | 53.70 | 60.00 | 81.62 | D/H/DL/DP | — | — | — | — | ○ | ○ | ○ |
| 1152 x 864/70 | 1 152 x 864 | 63.99 | 70.02 | 94.20 | R/D/H/DL/DP | — | — | — | — | — | — | — |
| 1152 x 864/75 | 1 152 x 864 | 67.50 | 75.00 | 108.00 | R/D/H/DL/DP | — | — | — | — | — | — | — |
| 1152 x 864/85 | 1 152 x 864 | 77.09 | 85.00 | 119.65 | R/D/H/DL/DP | — | — | — | — | — | — | — |
| 1152 x 870/75 | 1 152 x 870 | 68.68 | 75.06 | 100.00 | R/D/H/DL/DP | — | — | — | — | — | — | — |
| 1280 x 720/60 | 1 280 x 720 | 44.76 | 60.00 | 74.48 | R/D/H/DL/DP | — | — | — | — | ○ | ○ | ○ |
| 1280 x 768/50 | 1 280 x 768 | 39.55 | 49.94 | 65.18 | R/D/H/DL/DP | — | — | — | — | — | — | — |
| 1280 x 768/60 | 1 280 x 768 | 47.70 | 60.00 | 80.14 | R/D/H/DL/DP | — | — | — | — | — | — | — |
| 1280 x 768/60 | 1 280 x 768 | 47.78 | 59.87 | 79.50 | R/D/H/DL/DP | — | — | — | — | — | — | — |
| 1280 x 800/50 | 1 280 x 800 | 41.20 | 50.00 | 68.56 | R/D/H/DL/DP | — | — | — | — | — | — | — |
| 1280 x 800/60 | 1 280 x 800 | 49.31 | 59.91 | 71.00 | R/D/H/DL/DP | — | — | — | — | — | — | — |
| 1280 x 800/60 | 1 280 x 800 | 49.70 | 59.81 | 83.50 | R/D/H/DL/DP | — | — | — | — | ○ | ○ | ○ |
| 1280 x 960/60 | 1 280 x 960 | 60.00 | 60.00 | 108.00 | R/D/H/DL/DP | — | — | — | — | — | — | — |
| 1280 x 960/85 | 1 280 x 960 | 85.94 | 85.00 | 148.50 | R | — | — | — | — | — | — | — |
| 1280 x 1024/60 | 1 280 x 1 024 | 63.98 | 60.02 | 108.00 | R/D/H/DL/DP | ○ | ○ | ○ | ○ | ○ | ○ | ○ |
| 1280 x 1024/75 | 1 280 x 1 024 | 79.98 | 75.02 | 135.00 | R/D/H/DL/DP | — | — | — | — | — | — | — |
| 1280 x 1024/85 | 1 280 x 1 024 | 91.15 | 85.02 | 157.50 | R/D/H/DL/DP | — | — | — | — | — | — | — |
| 1360 x 768/60 | 1 360 x 768 | 47.71 | 60.02 | 85.50 | D/H/DL/DP | — | — | — | — | — | — | — |
| 1360 x 768/60 | 1 360 x 768 | 47.70 | 60.00 | 84.72 | D/H/DL/DP | — | — | — | — | — | — | — |
| 1360 x 768/60 | 1 360 x 768 | 47.72 | 59.80 | 84.75 | D/H/DL/DP | — | — | — | — | — | — | — |
| 1366 x 768/50 | 1 366 x 768 | 39.55 | 50.00 | 69.92 | D/H/DL/DP | — | — | — | — | — | — | — |
| 1366 x 768/60 | 1 366 x 768 | 48.39 | 60.03 | 86.71 | R/D/H/DL/DP | — | — | — | — | — | — | — |
| 1366 x 768/60 | 1 366 x 768 | 48.00 | 60.00 | 72.00 | R/D/H/DL/DP | — | — | — | — | — | — | — |
| 1366 x 768/50 | 1 366 x 768 | 39.56 | 49.89 | 69.00 | R/D/H/DL/DP | — | — | — | — | — | — | — |
| 1366 x 768/60 | 1 366 x 768 | 47.71 | 59.79 | 85.50 | R/D/H/DL/DP | — | — | — | — | — | — | — |
| 1400 x 1050/60 | 1 400 x 1 050 | 65.22 | 60.00 | 122.61 | D/H/DL/DP | — | — | — | — | — | — | — |
| 1400 x 1050/75 | 1 400 x 1 050 | 82.20 | 75.00 | 155.85 | R/D/H/DL/DP | — | — | — | — | — | — | — |
| 1440 x 900/60 | 1 440 x 900 | 55.47 | 59.90 | 88.75 | R/D/H/DL/DP | — | — | — | — | — | — | — |
| 1440 x 900/60 | 1 440 x 900 | 55.92 | 60.00 | 106.47 | R/D/H/DL/DP | — | — | — | — | — | — | — |
| 1600 x 900/50 | 1 600 x 900 | 46.30 | 50.00 | 97.05 | D/H/DL/DP | — | — | — | — | — | — | — |
| 1600 x 900/60 | 1 600 x 900 | 60.00 | 60.00 | 108.00 | D/H/DL/DP | — | — | — | — | — | — | — |
| 1600 x 900/60 | 1 600 x 900 | 55.99 | 59.95 | 118.25 | D/H/DL/DP | — | — | — | — | — | — | — |
| 1600 x 900/60 | 1 600 x 900 | 55.92 | 60.00 | 119.00 | D/H/DL/DP | — | — | — | — | ○ | ○ | ○ |
| 1600 x 1200/60 | 1 600 x 1 200 | 75.00 | 60.00 | 162.00 | R/D/H/DL/DP | — | — | — | — | — | — | — |
| 1680 x 1050/60 | 1 680 x 1 050 | 65.29 | 59.95 | 146.25 | R/D/H/DL/DP | — | — | — | — | — | — | — |
| 1920 x 1080/60 | 1 920 x 1 080*3 | 66.59 | 59.93 | 138.50 | R/D/H/DL/DP | — | — | — | — | — | — | — |

| Corresponding signal | Resolution (Dot) | Scanning frequency | | Dot clock frequency (MHz) | Format*2 | Plug and Play-supported signal*5 | | | | | | |
|----------------------|------------------|--------------------|---------------|---------------------------|-------------|----------------------------------|--------|--------|--------|----|----|----------|
| | | Horizontal (kHz) | Vertical (Hz) | | | HDMI | | | | DL | DP | DVI-D/PC |
| | | | | | | EDID 1 | EDID 2 | EDID 3 | EDID 4 | | | |
| 1920 x 1080/60 | 1 920 x 1 080 | 67.50 | 60.00 | 148.50 | R/D/H/DL/DP | ○ | ○ | ○ | ○ | ○ | ○ | ○ |
| 1920 x 1200/60 | 1 920 x 1 200 | 74.04 | 59.95 | 154.00 | R/D/H/DL/DP | ○ | ○ | ○ | ○ | ○ | ○ | ○ |
| 1920 x 2160/60 | 1 920 x 2 160 | 133.29 | 59.99 | 277.25 | H/DL/DP | — | — | — | — | — | — | — |
| 1920 x 2160/60 | 1 920 x 2 160 | 135.00 | 60.00 | 297.00 | H/DL/DP | — | — | — | — | — | — | — |
| 2560 x 1440/60 | 2 560 x 1 440 | 88.79 | 59.95 | 241.50 | H/DL/DP | — | — | ○ | — | ○ | ○ | — |
| 2560 x 1600/50 | 2 560 x 1 600 | 82.37 | 49.95 | 286.00 | H/DL/DP | — | — | — | — | — | — | — |
| 2560 x 1600/60 | 2 560 x 1 600 | 98.71 | 59.97 | 268.50 | H/DL/DP | — | — | — | — | — | — | — |
| 3840 x 1080/60 | 3 840 x 1 080 | 66.63 | 59.97 | 266.50 | H/DL/DP | — | — | — | — | — | — | — |
| 3840 x 2160/30 | 3 840 x 2 160 | 65.69 | 29.98 | 262.75 | H/DL/DP | — | — | — | — | — | ○ | — |
| 3840 x 2160/60 | 3 840 x 2 160 | 133.31 | 60.00 | 533.25 | H/DP | — | — | — | — | — | ○ | — |

*1: Pixel-Repetition signal (dot clock frequency 27.0 MHz) only

*2: Signals to represent formats are as follows.

R: D-sub RGB (PC IN)

Y: YPbPr/YCbCr (PC IN)

D: DVI-D (DVI-D IN)

H: HDMI (HDMI 1, HDMI 2)

DL : DIGITAL LINK (DIGITAL LINK)

DP : DisplayPort (DisplayPort)

The analogue input supports onG and onY.

*3: Based on VESA CVT-RB (Reduced Blanking) standard

*4: YCbCr420 format only supported.

*5: Signals with ○ in the Plug and Play-supported signal column are the ones written in EDID (Extended Display Identification Data) of this unit.

For signals without ○ in the Plug and Play-supported signal column, resolutions may not be selected on the PC side even if this unit supports those signals.

Note

- An auto detected signal format may be differently displayed from the actual input signal.
- [i] shown after the number of dots of resolution means the interlace signal.
- When 1080/30PsF signal and 1080/25PsF signal are input, they are processed as 1080/60i signal and 1080/50i signal, and then displayed.
- When 1920 x 2160/60 signal (dot clock frequency 297.00 MHz, DIGITAL LINK format) is input, 3840x2160/60p is displayed.

Shipping condition

It is possible to reset the following data to the factory settings.

Settings and set values of [Picture], [Sound], [Setup] and [Position] menus and user image registered in [Setup] - [Image settings]

■ Remote control

- 1 Press <SETUP> to display the [Setup] menu.
- 2 Select [Options] with ▲ ▼ and press <ENTER>.

The following screen will be displayed.

| |
|---------------------|
| Display information |
| Software licenses |
| Cloning password |
| USB data cloning |
| LAN data cloning |
| Output log data |
| Shipping |

- 3 Select [Shipping] with ▲ ▼ and press <ENTER>.

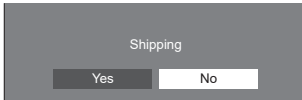

- 4 Select [Yes] with ◀ ▶ and press <ENTER>.

The message [Shipping (Wait a moment)] will be displayed.

- 5 After the message [Please turn off the power.] is displayed, turn the power off pressing <Main Power On / Off button> (⏻/⏷).

- If the <Main Power On / Off button> is locked, please disconnect the AC cord plug from the wall outlet.

■ Unit

- 1 Press <MENU (Unit)> for several times and display the [Setup] menu.
- 2 Select [OSD language] with ▲ ▼, and then press and hold <ENTER (Unit)> for more than 5 seconds.
- 3 Select [Yes] with <- (Unit)> and press <ENTER (Unit)>.
The message [Shipping (Wait a moment)] will be displayed.
- 4 After the message [Please turn off the power.] is displayed, turn the power off pressing <Main Power On / Off button> (⏻/⏷).

- If the <Main Power On / Off button> is locked, please disconnect the AC cord plug from the wall outlet.

Initialization

When both main unit buttons and remote control buttons are disabled due to the [Button lock], [Controller user level] and [Controller ID function] settings, set all the values [Off] so that all the buttons are enabled again.

Press <- (Unit)> together with <RETURN> and hold for more than 5 seconds.

[Shipping] is displayed and the lock is released when it disappears.

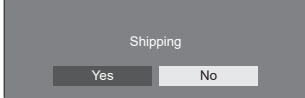

- Settings for [Button lock], [Controller user level] and [Controller ID function] will be back to [Off].

Initializing the [Controller user level]

When remote control buttons are disabled due to the [Controller user level] (page 89) setting, set the value [Off] so that all the buttons are enabled again.

Press <SETUP> and hold for more than 5 seconds.











- Setting for [Controller user level] will be back to [Off].

Note

- For 98/86/65/55/49 inch models, this setting is available only when the main software version is 4.0000 or later.

Troubleshooting

Before you call for service, determine the symptoms and make a few simple checks as shown below.

| Symptoms | | Check |
|---|---|---|
| Picture | Sound | |
|  Interference |  Noisy Sound | Electrical Appliances Cars / Motorcycles Fluorescent light |
|  Normal Picture |  No Sound | Volume (Check whether the mute function has been activated on the remote control.) |
|  No Picture |  No Sound | Not plugged into AC outlet Not switched on Picture and Brightness/Volume setting (Check by pressing the <Main Power On / Off button> or the <Standby (ON/OFF) button>.) |
|  No Picture |  Normal Sound | If a signal with a non-applicable colour system format, or frequency is input, only the input terminal indication is displayed. |
|  No Colour |  Normal Sound | Colour controls set at minimum level (see page 48, 50) |
| A display error such as "no picture" occurs, or remote control operation is suddenly disabled. | | This unit incorporates highly-advanced software. If you notice an abnormal operation such as "Remote control cannot be operated" or "Display is disturbed", remove the power plug from the socket outlet, and inset it again after 5 seconds or more to turn the power on. (see page 35) |
| Power automatically turns off unexpectedly. | | Check the settings of [No signal power off], [HDMI1 power management], [HDMI2 power management], [DisplayPort power management], [DIGITAL LINK power management], [DVI-D power management], [PC power management] and [No activity power off]. Any of them may be set to [On (Enable)]. (see page 69) |
| Power indicator is blinking in red. | | There is possibility of malfunction. Please contact an Authorized Service Centre. |
| No remote control operations can be performed. | | Check whether the batteries have discharged completely and, if they have not, whether they were inserted properly. Check whether the remote control sensor is exposed to an outdoor light or a strong fluorescent light. Check whether any obstacle is present between the remote control sensor and the remote control. (see page 32) If the installation condition is normal, pull out the remote control sensor from the edge side of the main unit when using. Check whether the remote control designed specifically for use with the unit is being used. (The unit cannot be operated by any other remote control.) Check whether the option other than [Off] is selected in [Controller user level]. (see page 89) Check whether [Controller ID function] is set to [On]. (see page 87) Check whether <ID MODE> switch is set to <ON>. (When using ID remote controller) (see page 136) |

| Symptoms | Check |
|--|--|
| [Controller ID function] function cannot be used. (When using ID remote controller) | Check whether [Controller ID function] is set to [On], or <ID MODE> switch is set to <ON>. (see page 87) (When [Controller ID function] is set to [On], you need to set <ID MODE> switch to <ON> and set the ID number.) |
| The top or bottom of the picture on the screen is cut off. | The image position has been adjusted in the [Position] menu. Adjust the position of the picture on the screen. (see page 45, 46) |
| There are areas at the top and bottom of the screen where picture is not displayed. | When using a video software program (such as a cinema size program) with a screen wider than one in the 16:9 mode, blank areas separate from the images are formed at the top and bottom of the screen. |
| Parts of the unit become hot. | Even when the temperature of parts of the front, top and rear panels has risen, these temperature rises will not pose any problems in terms of performance or quality. |
| There is no picture displayed or sound output sometimes. | When HDMI or DVI signals are input to the Display using a selector or distributor, sound or images may not be output in the normal fashion depending on the selector or distributor used. The symptoms may be improved by turning the power off and on again, or by replacing the selector or distributor. |
| A small sound becomes loud or the volume of a large sound is restricted. Noise is disturbing. The volume balance between vocals and musical instruments is poor when listening to music. | Check that [Auto volume] is not active (Min / Mid / Max). (see page 47) |
| Sound distortion or noise annoys you. | Check whether the rated (0.5 Vrms) audio or more is input to audio input terminals (AUDIO IN 1, AUDIO IN 2). Use the unit within the rated audio input. (see page 147) |
| The RS-232C is uncontrollable. | Check whether the connection has been made properly. (see page 28) |
| The LAN is uncontrollable. | Check that the connection has been made properly. (see page 91) To control with WEB browser control or command control, check that [Network settings] - [Network control] is set to [On]. (see page 77) Check that [LAN setup] is set properly. (see page 78) When connecting to a device of AMX, Extron or Crestron Electronics, Inc., set [AMX D. D.], [Extron XTP] or [Crestron Connected™] according to the device to use. (see page 80) See the [DIGITAL LINK status] - [Signal quality] information to check the LAN cable status such as whether the LAN cable is disconnected or the cable is not shielded. (see page 80) |
| There is no picture displayed or sound output from the [DIGITAL LINK] terminal. | Check whether the connection has been made properly between the video (output) equipment and twisted pair cable transmitter and between the twisted pair cable transmitter and this product. (see page 92) Check that [Network settings] - [DIGITAL LINK mode] is not set to [Ethernet]. (see page 79) |
| The file can be played back with "USB media player", but not with "Memory viewer" | Check the playback file specifications of "USB media player" (see page 112) and "Memory viewer" (see page 123). |

LCD Display panel

| Symptoms | Check |
|--|--|
| The screen darkens slightly when bright pictures with minimal movements are shown. | The screen will darken slightly when photos, still images of a computer or other pictures with minimal movements are shown for an extended period. This is done to reduce image retention on the screen and the shortening of the screen's service life: It is normal and not indicative of malfunctioning. |
| It takes a while for the picture to appear. | The unit digitally processes the various signals in order to reproduce esthetically pleasing images. As such, it sometimes takes a few moments for the picture to appear when the power has been turned on, when the input has been switched. |
| The edges of the images flicker. | Due to the characteristics of the system used to drive the liquid crystal panel, the edges may appear to flicker in the fast-moving parts of the images: This is normal and not indicative of malfunctioning. |
| There may be red spots, blue spots, green spots and black spots on the screen. | This is a characteristic of liquid crystal panels and is not a problem. The liquid crystal panel is built with very high precision technology giving you fine picture details. Occasionally, a few non-active pixels may appear on the screen as fixed points of red, blue, green, or black. Please note this does not affect the performance of your LCD. |
|  <p>Image retention appears</p> | Image retention may occur. If you display a still picture for an extended period, the image might remain on the screen. However, it will disappear when a general moving picture is displayed for a while. This is not considered as malfunction. |

This LCD Display uses special image processing. Hence a slight time lag may occur between image and audio, depending on the type of input signal. However, this is not a malfunction.

Specifications

Model No.

98-inch model : TH-98SQ1W

86-inch model : TH-86SQ1W

75-inch model : TH-75SQ1W

65-inch model : TH-65SQ1W

55-inch model : TH-55SQ1W

49-inch model : TH-49SQ1W

Power Consumption

98-inch model

685 W

86-inch model

480 W

75-inch model

385 W

65-inch model

320 W

55-inch model

300 W

49-inch model

285 W

Power off condition

0.3 W

Stand-by condition

0.5 W

LCD Display panel

98-inch model

98-inch IPS panel (Direct LED backlight),
16:9 aspect ratio

86-inch model

86-inch IPS panel (Edge LED backlight),
16:9 aspect ratio

75-inch model

75-inch IPS panel (Edge LED backlight),
16:9 aspect ratio

65-inch model

65-inch IPS panel (Edge LED backlight),
16:9 aspect ratio

55-inch model

55-inch IPS panel (Edge LED backlight),
16:9 aspect ratio

49-inch model

49-inch IPS panel (Edge LED backlight),
16:9 aspect ratio

Screen size

98-inch model

2 158.8 mm (W) × 1 214.3 mm (H) × 2 476.9 mm
(diagonal) / 84.99" (W) × 47.80" (H) × 97.51"
(diagonal)

86-inch model

1 895.0 mm (W) × 1 065.9 mm (H) × 2 174.2 mm
(diagonal) / 74.60" (W) × 41.96" (H) × 85.60"
(diagonal)

75-inch model

1 649.6 mm (W) × 927.9 mm (H) × 1 892.7 mm
(diagonal) / 64.94" (W) × 36.53" (H) × 74.51"
(diagonal)

65-inch model

1 428.4 mm (W) × 803.5 mm (H) × 1 638.9 mm
(diagonal) / 56.23" (W) × 31.63" (H) × 64.52"
(diagonal)

55-inch model

1 209.6 mm (W) × 680.4 mm (H) × 1 387.8 mm
(diagonal) / 47.62" (W) × 26.78" (H) × 54.63"
(diagonal)

49-inch model

1 073.8 mm (W) × 604.0 mm (H) × 1 232.0 mm
(diagonal) / 42.27" (W) × 23.77" (H) × 48.50"
(diagonal)

No. of pixels

8 294 400

(3 840 (Horizontal) × 2 160 (Vertical))

Dimensions (W × H × D)

98-inch model

2 194 mm × 1 249 mm × 90 mm
(excluding handles: 81 mm) /
86.35" × 49.15" × 3.54"
(excluding handles: 3.17")

86-inch model

1 928 mm × 1 099 mm × 86 mm
(excluding handles: 76 mm) /
75.91" × 43.27" × 3.39"
(excluding handles: 2.99")

75-inch model

1 681 mm × 959 mm × 73 mm (excluding handles:
66 mm) / 66.15" × 37.75" × 2.87" (excluding handles:
2.58")

65-inch model

1 458 mm × 836 mm × 77 mm
(excluding handles: 69 mm) /
57.40" × 32.90" × 3.02"
(excluding handles: 2.73")

55-inch model

1 240 mm × 714 mm × 74 mm
(excluding handles: 66 mm) /
48.82" × 28.09" × 2.88"
(excluding handles: 2.58")

49-inch model

1 105 mm × 637 mm × 74 mm
(excluding handles: 66 mm) /
43.48" × 25.08" × 2.88"
(excluding handles: 2.58")

Mass

98-inch model

Approx. 90.0 kg / 198.5 lbs net

86-inch model

Approx. 66.0 kg / 145.5 lbs net

75-inch model

Approx. 56.0 kg / 123.5 lbs net

65-inch model

Approx. 36.0 kg / 79.4 lbs net

55-inch model

Approx. 25.5 kg / 56.3 lbs net

49-inch model

Approx. 21.0 kg / 46.3 lbs net

Power source

110 – 240 V ~ (110 – 240 V alternating current),
50/60 Hz

Operating condition

Temperature

0 °C – 40 °C (32 °F – 104 °F)*1,3

Humidity

20 % – 80 % (no condensation)

Storing condition

Temperature

-20 °C – 60 °C (-4 °F – 140 °F)

Humidity

20 % – 80 % (no condensation)

Operating Time

24 hours/day

Supply power for SLOT

3.3 V/max 1.1 A, 12 V/max 5.5 A

Connection terminals

HDMI 1

HDMI 2

TYPE A Connector*2 × 2 (Supports 4K)

Compatible with HDCP 2.2

Audio signal:

Linear PCM (sampling frequencies: 48 kHz,
44.1 kHz, 32 kHz)

DisplayPort IN

DisplayPort Terminal × 1

Compatible with HDCP 2.2

Audio signal:

Linear PCM (sampling frequencies: 48 kHz,
44.1 kHz, 32 kHz)

DisplayPort OUT

DisplayPort Terminal × 1

Compatible with HDCP 1.4

DVI-D IN

DVI-D 24 Pin × 1:

Compliance with DVI Revision 1.0

Compatible with HDCP 1.1

PC IN

Mini D-sub 15 Pin (Compatible with DDC2B) × 1
Y/G:

1.0 Vp-p (75 Ω) (with sync signal)

0.7 Vp-p (75 Ω) (without sync signal)

P_B/C_B/B:

0.7 Vp-p (75 Ω) (without sync signal)

P_R/C_R/R:

0.7 Vp-p (75 Ω) (without sync signal)

HD/VD:

TTL (high impedance)

AUDIO IN 1

Stereo mini jack (M3) × 1, 0.5 Vrms

AUDIO IN 2

Stereo mini jack (M3) × 1, 0.5 Vrms

AUDIO OUT

Stereo mini jack (M3) × 1, 0.5 Vrms

Output: Variable (-∞ – 0 dB)

(1 kHz 0 dB input, 10 kΩ load)

SERIAL IN

External Control Terminal

D-sub 9 Pin × 1:

RS-232C compatible

LAN

RJ45 × 1:

For network connection, compatible with PjLink
Communication method:

RJ45, 10BASE-T / 100BASE-TX

DIGITAL LINK / LAN

RJ45 × 1:

For network connection, DIGITAL LINK connection, compatible with PjLink

Communication method:

RJ45, 100BASE-TX, long reach mode is supported

Compatible with HDCP 2.2

IR IN

Stereo mini jack (M3) × 1

IR OUT

Stereo mini jack (M3) × 1

USB

USB connector × 2, TYPE A

DC 5V/1A (front side terminal),

DC 5V/2A (far side terminal)

EXT SP

8 Ω, 30 W [15 W + 15 W] (10 % THD)

Sound

Speakers

98-inch model 86-inch model 75-inch model

15 mm × 25 mm × 1 / φ 70 mm × 1 × 2 pieces

65-inch model 55-inch model 49-inch model

φ 30 mm × 2 × 2 pieces

Audio Output

20 W [10 W + 10 W] (10 % THD)

Remote Control Transmitter

Power source

DC 3 V (battery (AAA/R03/LR03 type) × 2)

Operating range

Approx. 7 m (22.9 ft)

(when operated directly in front of remote control sensor)

Mass

Approx. 63 g / 2.22 oz (including batteries)

Dimensions (W × H × D)

48 mm × 134 mm × 20 mm / 1.89" × 5.28" × 0.76"

*1: Environmental temperature to use this unit at high altitudes (1 400 m (4 593 ft) and higher and below 2 800 m (9 186 ft) above sea level): 0 °C to 35 °C (32 °F to 95 °F)

*2: VIERA LINK is not supported.

*3: Temperature of operating condition when using the unit with its liquid crystal panel facing upright is shown below.

65-inch model:

0 °C – 35 °C (32 °F – 95 °F)

55-inch model 49-inch model:

0 °C – 30 °C (32 °F – 86 °F)

When installing the unit with its liquid crystal panel facing upright, ask your local Panasonic dealer. There are conditions of mounting method, environmental temperature, connections and settings.

Note

- Design and specifications are subject to change without notice. Mass and dimensions shown are approximate.

Software License

This product incorporates the following software:

- (1) the software developed independently by or for Panasonic Corporation,
- (2) the software owned by third party and licensed to Panasonic Corporation,
- (3) the software licensed under the GNU General Public License, Version 2.0 (GPL V2.0),
- (4) the software licensed under the GNU LESSER General Public License, Version 2.1 (LGPL V2.1), and/or
- (5) open source software other than the software licensed under the GPL V2.0 and/or LGPL V2.1.

The software categorized as (3) - (5) are distributed in the hope that it will be useful, but WITHOUT ANY WARRANTY, without even the implied warranty of MERCHANTABILITY or FITNESS FOR A PARTICULAR PURPOSE. For details, see the license conditions displayed by selecting [Software licenses], following the specified operation from the [Settings] menu of this product.

At least three (3) years from delivery of this product, Panasonic will give to any third party who contacts us at the contact information provided below, for a charge no more than our cost of physically performing source code distribution, a complete machine-readable copy of the corresponding source code covered under GPL V2.0, LGPL V2.1 or the other licenses with the obligation to do so, as well as the respective copyright notice thereof.

Contact Information:

oss-cd-request@gg.jp.panasonic.com

Notice about AVC/VC-1/MPEG-4

This product is licensed under the AVC Patent Portfolio License, VC-1 Patent Portfolio License and MPEG-4 Visual Patent Portfolio License for the personal use of a consumer or other uses in which it does not receive remuneration to (i) encode video in compliance with the AVC Standard, VC-1 Standard and MPEG-4 Visual Standard ("AVC/VC-1/MPEG-4 Video") and/or (ii) decode AVC/VC-1/MPEG-4 Video that was encoded by a consumer engaged in a personal activity and/or was obtained from a video provider licensed to provide AVC/VC-1/MPEG-4 Video. No license is granted or shall be implied for any other use. Additional information may be obtained from MPEG LA, LLC. See <http://www.mpegla.com>.

Disposal of Old Equipment and Batteries

Only for European Union and countries with recycling systems



These symbols on the products, packaging, and/or accompanying documents mean that used electrical and electronic products and batteries must not be mixed with general household waste. For proper treatment, recovery and recycling of old products and used batteries, please take them to applicable collection points in accordance with your national legislation.

By disposing of them correctly, you will help to save valuable resources and prevent any potential negative effects on human health and the environment.

For more information about collection and recycling, please contact your local municipality. Penalties may be applicable for incorrect disposal of this waste, in accordance with national legislation.

EU



Note for the battery symbol (bottom symbol)

This symbol might be used in combination with a chemical symbol. In this case it complies with the requirement set by the Directive for the chemical involved.

Information on Disposal in other Countries outside the European Union

These symbols are only valid in the European Union.

If you wish to discard these items, please contact your local authorities or dealer and ask for the correct method of disposal.

Notice (U.S.A. only)

Disposal may be regulated in your community due to environmental considerations. For disposal or recycling information, please visit Panasonic website:

<https://www.panasonic.com/us/corporate/sustainability.html>

or call 1-888-769-0149.

Customer's Record

The model number and serial number of this product may be found on its rear panel. You should note this serial number in the space provided below and retain this book, plus your purchase receipt, as a permanent record of your purchase to aid in identification in the event of theft or loss, and for Warranty Service purposes.

Model Number

Serial Number

Panasonic System Solutions Company of North America

Unit of Panasonic Corporation of North America

Executive Office :

Two Riverfront Plaza, Newark, New Jersey 07102

Panasonic Canada Inc.

5770 Ambler Drive

Mississauga, Ontario

L4W 2T3

Panasonic Testing Centre

Panasonic Service Europe, a division of Panasonic Marketing Europe GmbH

Winsbergring 15, 22525 Hamburg, F.R. Germany

Panasonic Corporation

Web Site: <https://panasonic.net/cns/prodisplays/>

English