

## Operating Instructions <Operations and Settings>

Remote Camera Controller

Model No. **AW-RP120G**

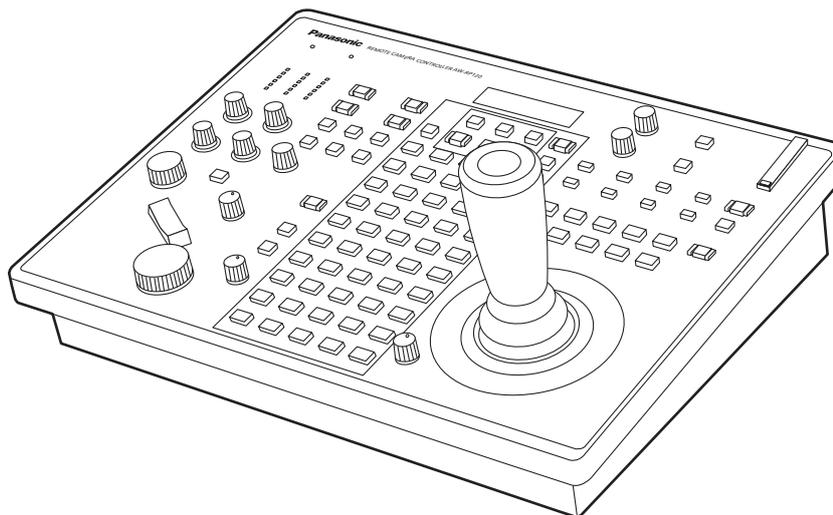

- **How the Operating Instructions are configured**

- <Basics>:

- The <Basics> describes the procedure for connection with the required equipment and for installation. Before installing this unit, be sure to take the time to read through <Basics> to ensure that the unit will be installed correctly.

- <Operations and Settings> (this manual):

- This <Operations and Settings> describes how to operate the unit and how to establish its settings.

# Contents

|   |           |
|---|-----------|
| <b>How to turn on and off the power of the remote cameras</b> . . . . .                                 | <b>3</b>  |
| How to turn on the power of the remote cameras . . . . .  | 3         |
| How to turn off the power of the remote cameras . . . . .   | 4         |
| <b>Making image adjustments for the selected remote camera</b> . . . . .                                | <b>5</b>  |
| Setting the gain . . . . .  | 6         |
| Setting the pedestal . . . . .  | 6         |
| Setting the white balance . . . . .   | 6         |
| Setting the black balance . . . . .   | 7         |
| Selecting the color bars . . . . .  | 8         |
| Setting the detail . . . . .  | 8         |
| Adjusting the shutter speed . . . . .   | 8         |
| Setting the shooting mode (SCENE 1 to SCENE 4) . . . . .  | 9         |
| Setting an ND filter . . . . .  | 10        |
| <b>Operating the OSD menu of a remote camera</b> . . . . .  | <b>11</b> |
| <b>Operating preset memory (PMEM)</b> . . . . .   | <b>12</b> |
| Registering preset memory (STORE) . . . . .   | 13        |
| Recalling preset memory (RECALL) . . . . .  | 13        |
| Deleting preset memory (DELETE) . . . . .   | 13        |
| Setting the operation items for when preset memory<br>is recalled (PRESET SCOPE) . . . . .              | 14        |
| Setting the speed at which to move to the position<br>set in the preset memory (PRESET SPEED) . . . . . | 14        |
| <b>Operating preset memory groups (PMEM GROUP)</b> . . . . .  | <b>16</b> |
| Setting the operation mode (SEPARATE/ALL) . . . . .   | 16        |
| Creating preset memory groups . . . . .   | 16        |
| Recalling preset memory groups . . . . .  | 17        |
| <b>Operating tracing memory (TMEM)</b> . . . . .  | <b>18</b> |
| Registering tracing memory (STORE) . . . . .  | 18        |
| Recalling tracing memory (RECALL) . . . . .   | 19        |
| Deleting tracing memory (DELETE) . . . . .  | 20        |
| Restoring tracing memory (RESTORE) . . . . .  | 20        |
| Setting the items to recall when recalling tracing memory . . . . .                                     | 21        |
| <b>Configuring the remote camera operation settings</b> . . . . .                                       | <b>22</b> |
| Adjusting the operation speed of the pan, tilt, zoom, and focus . . . . .                               | 22        |
| Setting the PAN/TILT lever inclination and speed . . . . .  | 22        |
| Setting the pan, tilt, zoom, and focus operation directions . . . . .                                   | 23        |
| Setting the minimum lens zoom start speed . . . . .   | 24        |
| Setting the speed of the pan and tilt operations<br>for telephoto shooting . . . . .                    | 24        |
| Setting the movement ranges (limiter function)<br>of a remote camera . . . . .                          | 25        |
| Returning a remote cameras to its home position . . . . .   | 25        |
| Controlling the peripheral devices connected<br>to a remote camera . . . . .                            | 26        |
| <b>Configuring the unit operation settings</b> . . . . .  | <b>27</b> |
| Enabling or disabling operation with the ENABLE buttons . . . . .                                       | 27        |
| Enabling or disabling operation of the ENABLE buttons<br>by menu operation . . . . .                    | 28        |
| Enabling or disabling menu operation . . . . .  | 28        |
| Switching the focus operation and iris operation . . . . .  | 29        |
| Setting the LCD panel backlight . . . . .   | 29        |
| Assigning functions to the USER buttons . . . . .   | 30        |
| <b>Setting linking with a switcher</b> . . . . .  | <b>31</b> |
| Registering the camera numbers that will correspond to the image<br>inputs of the switcher . . . . .    | 31        |
| Enabling or disabling the function for linking with the switcher . . . . .                              | 31        |
| <b>Setting the functions for when the unit is linked<br/>with the switcher</b> . . . . .                | <b>32</b> |
| BUSCONT function . . . . .  | 32        |
| FOCUS ASSIST function . . . . .   | 33        |
| CAMERA SELECT view function . . . . .   | 33        |
| TALLY IP function . . . . .   | 34        |
| Operating the switcher with the PAN/TILT lever<br>and ZOOM button . . . . .                             | 34        |
| CAM INF function . . . . .  | 35        |
| <b>Memory card operations</b> . . . . .   | <b>36</b> |
| Initializing a memory card (INIT) . . . . .   | 37        |
| Saving data to a memory card (SAVE) . . . . .   | 37        |
| Loading data from a memory card (LOAD) . . . . .  | 38        |
| Deleting the files saved to a memory card (DELETE) . . . . .  | 38        |
| <b>Tally settings</b> . . . . .   | <b>39</b> |
| Registering the camera numbers that will correspond<br>to the TALLY inputs . . . . .                    | 39        |
| Setting the sending of tally information from the unit<br>to remote cameras . . . . .                   | 39        |
| <b>Checking alarm information</b> . . . . .   | <b>40</b> |
| Displaying alarm information . . . . .  | 40        |
| <b>Returning the unit to the factory default state (INITIALIZE)</b> . . . . .                           | <b>41</b> |
| Returning the unit to the factory default state . . . . .   | 42        |
| <b>Control interface for external devices</b> . . . . .   | <b>43</b> |
| <b>Setup Software</b> . . . . .   | <b>45</b> |
| Installing the software . . . . .   | 45        |
| Configuring the settings of the personal computer . . . . .   | 45        |
| Connecting the personal computer . . . . .  | 46        |
| Registering the unit in Setup Software . . . . .  | 47        |
| Settings for connecting with the remote cameras and switcher . . . . .                                  | 48        |
| Setting user authentication . . . . .   | 50        |
| <b>Operations of AW-HE2</b> . . . . .   | <b>51</b> |
| <b>Table of setting items (dedicated dials and buttons)</b> . . . . .                                   | <b>52</b> |
| <b>Table of setting items (menus)</b> . . . . .   | <b>53</b> |
| <b>Messages</b> . . . . .   | <b>56</b> |
| <b>Index</b> . . . . .  | <b>58</b> |

# How to turn on and off the power of the remote cameras

## How to turn on the power of the remote cameras

The power of the remote cameras in the standby state can be turned on from the unit.

There are the following methods of turning on the power.

- Turning on the power one camera at a time
- Turning on the power of the cameras simultaneously with the turning on of the unit's power
- Turning on the power of multiple cameras
  - ◇ Turning on the power of all the cameras
  - ◇ Turning on the power of the selected camera group

Each of these methods is described in turn below.

### Turning on the power one camera at a time

#### 1. Select the remote camera.

When the corresponding camera selection button [CAMERA SELECT/GROUP SELECT] is held down for approximately 3 seconds, the name of the remote camera is displayed on the top line of the LCD panel and "POWER: OFF↓" is displayed on the bottom line.

#### 2. Turn the F2 dial to select "ON" while keeping the camera selection button held down and then press the F2 dial.

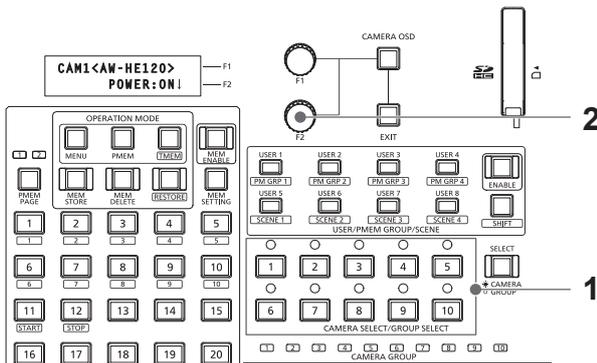

### Turning on the power of the cameras simultaneously with the turning on of the unit's power

1. Set the MENU button to ON.
2. Open CAMERA SETUP menu [24].
3. Turn the F1 dial to display the "2. AUTO ON" item.



4. Turn the F2 dial to select "On" and press the F2 dial. The power of the remote cameras set to "Serial" or "Network" in CTRL TYPE menu [36] will now turn on simultaneously with the turning on of the unit's power.

#### Note

- Depending on the number of cameras connected, it may take some time before you can operate the unit.

### Turning on the power of multiple cameras

1. Set the MENU button to ON. Press the MENU button to turn on its indicator.
2. Open CAMERA SETUP menu [24].
3. Turn the F1 dial to display the "1. CAM POWER" item.



#### ■ Turning on the power of all the cameras

4. Turn the F2 dial to select "ALL ON" and press the F2 dial.



#### ■ Turning on the power of the selected camera group

4. Turn the F2 dial to select "GROUP ON" and press the F2 dial.



## How to turn off the power of the remote cameras

The power of the remote cameras can be turned off from the unit. There are the following methods of turning off the power.

- Turning off the power one camera at a time
- Turning off the power of multiple cameras
  - ◇ Turning off the power of all the cameras
  - ◇ Turning off the power of the selected camera group

Each of these methods is described in turn below.

### Turning off the power one camera at a time

#### 1. Select the remote camera.

When the corresponding camera selection button [CAMERA SELECT/GROUP SELECT] is held down for approximately 3 seconds, the name of the remote camera is displayed on the top line of the LCD panel and "POWER: ON↓" is displayed on the bottom line.

#### 2. Turn the F2 dial to select "OFF" while keeping the camera selection button held down and then press the F2 dial.

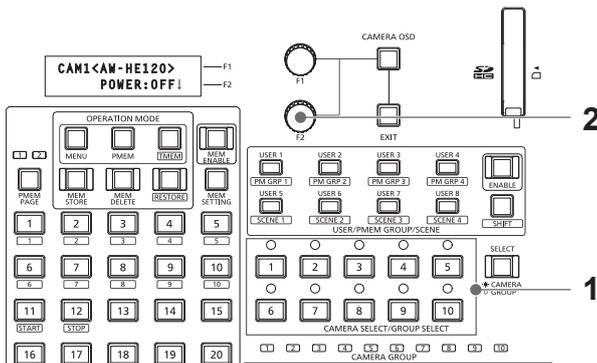

### Turning off the power of multiple cameras

1. Set the MENU button to ON.
2. Open CAMERA SETUP menu [24].
3. Turn the F1 dial to display the "1. CAM POWER" item.

1. CAM POWER  
GROUP ON↓

#### ■ Turning off the power of all the cameras

4. Turn the F2 dial to select "ALL OFF" and press the F2 dial.

1. CAM POWER  
ALL OFF↓

#### ■ Turning off the power of the selected camera group

4. Turn the F2 dial to select "GROUP OFF" and press the F2 dial.

1. CAM POWER  
GROUP OFF↓

# Making image adjustments for the selected remote camera

The following settings and adjustments can be made for the selected remote camera directly from this unit.

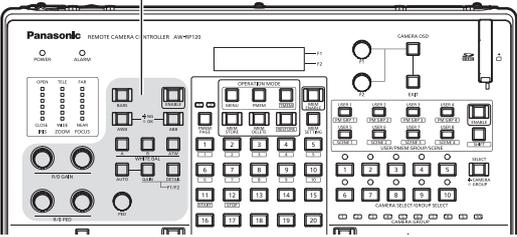
|   |  |
|---|--|
| <ul style="list-style-type: none"> <li>● Gain</li> <li>● Pedestal</li> <li>● R and B gain</li> <li>● R and B pedestal</li> <li>● White balance</li> <li>● Black balance</li> <li>● Color bar selection</li> <li>● Detail</li> </ul> | <p>Image adjustments can be made using the dedicated buttons and dials in the color adjustment section.</p>  |
| <ul style="list-style-type: none"> <li>● Shutter speed</li> </ul>   | <p>Image adjustments can be made by menu operation.</p>  |
| <ul style="list-style-type: none"> <li>● Shooting mode selection</li> </ul>   | <p>The shooting mode can be selected with SCENE1 to SCENE4.</p>  |

## <Color adjustment section>

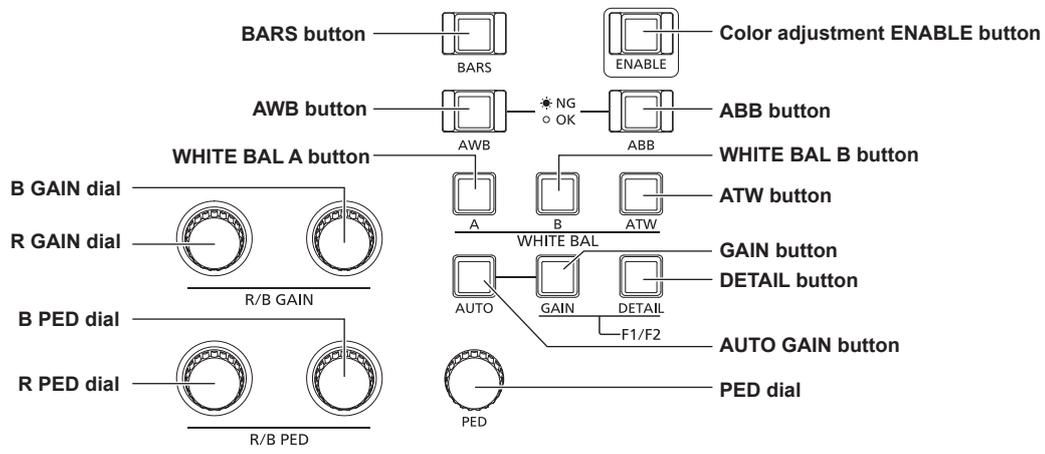

- When the color adjustment ENABLE button indicator is off, operation of the color adjustment section is disabled. Press the button to turn on its indicator and then perform operation.
- The setting value ranges of the gain, pedestal, R and B gain, R and B pedestal, detail, and shutter speed differ depending on the remote camera connected.  
For the setting value ranges of each remote camera, refer to “Table of setting items (menus)” (pages 53 to 55).
- Operation differs as follows when controlling AW-HE60 and AW-HE50.
  - During auto iris (when the auto iris button indicator is on), the shutter speed is adjusted automatically. The shutter speed value set from the unit is not immediately reflected for the camera output images at that time but instead is reflected when manual iris (when the auto iris indicator turns off) is set.
  - While the shooting mode is set to “FullAuto”, the following occurs.
    - Auto gain mode is fixed and the gain setting value cannot be changed from “AUTO”.
    - ATW mode is fixed and the R and B gain setting values cannot be changed.
    - Auto iris is fixed and the shutter speed setting value cannot be changed.
- With the AW-HE2, some operations differ from those described in this section. Refer to “Operations of AW-HE2” (page 51).

### Setting the gain

In places which are too dark, increase the gain level, and in places which are too bright, reduce the gain level.  
When the gain is increased, the noise level also increases.

#### 1. Press the GAIN button.

The current gain setting appears.

GAIN : 18dB

#### 2. Turn the F1 dial to select a setting.

- When the AUTO GAIN button is pressed, auto gain mode is enabled and the light quantity is adjusted automatically.
- If approximately 3 seconds elapses without the F1 dial being operated after the GAIN button is pressed, the previous LCD panel display is redisplayed.

### Setting the pedestal

When using multiple cameras, you need to set the same the black level (pedestal level) for images shot with each camera.

#### 1. Turn the PED dial to select a setting.

Adjustment in the minus (–) direction makes the parts closer to black, and adjustment in the plus (+) direction makes the parts closer to white.

- The setting value is displayed on the LCD panel during setting.
- When the PED dial is pressed, the setting value does not change and is only displayed.

PED : +150

### Setting the white balance

Adjust the ratio between R, G, and B (the three primary colors) so that white will be reproduced accurately.

When the white balance is off, not only will white be reproduced poorly but the color tone of the entire picture will also deteriorate.

The white balance needs to be set when the lighting conditions and brightness have changed. The white balance must also be adjusted when using a remote camera for the first time or when a remote camera has not been used for a prolonged period of time.

The white balance can be adjusted automatically or manually (fine adjustment after automatic adjustment), and results can be stored in two memory areas (A and B) of the remote camera. The result in a memory area can be recalled by pressing the WHITE BAL A button or WHITE BAL B button on the unit.

In addition, you can select the auto tracking white balance (ATW) mode for automatically tracking the white balance in accordance with the lighting conditions.

### Automatically adjusting the white balance

#### 1. With the selected remote camera, fill the screen with a white subject (white wall or paper).

- Make sure a shining object or very bright object does not appear on the screen.

#### 2. Press the WHITE BAL A button to turn on its indicator.

#### 3. Press the AWB button.

The AWB button indicator blinks and the white balance is adjusted automatically.

When adjustment ends successfully, the button indicator turns off and the adjustment results are registered to memory A.

When adjustment was not possible, the AWB button indicator turns on.

Try changing, for example, the lens iris, subject, and lighting conditions, and then perform adjustment again.

#### 4. Press the WHITE BAL B button to turn on its indicator.

#### 5. Press the AWB button.

Similar to step 3, the adjustment results are saved to memory B.

- When the white balance is adjusted automatically, the R and B GAIN setting values become "±0".

### Manually adjusting the white balance (R and B gain settings)

1. As with the automatic adjustment, fill the screen with a white subject.
2. Connect the video output of the currently selected remote camera to a waveform monitor.
3. Press the **WHITE BAL A** button to turn on its indicator.
4. Turn the **R GAIN** dial to select the R channel (red) setting, and turn the **B GAIN** dial to select the B channel (blue) setting.

The adjustment results are registered to memory A.

- The setting value is displayed during adjustment.
- When the R GAIN dial and B GAIN dial are pressed, the setting values do not change and are only displayed.

|          |      |
|----------|------|
| R GAIN : | +150 |
| B GAIN : | +150 |

5. Press the **WHITE BAL B** button to turn on its indicator.  
Perform step 4 in the same way as with the **WHITE BAL A** button to set memory B.

### Auto tracking white adjustment (ATW)

You can select the auto tracking white balance (ATW) mode for automatically tracking the white balance in accordance with the lighting conditions.

1. Press the **ATW** button to turn on its indicator.

ATW mode is enabled.

- If there is no white on the screen, it may not be possible to compensate the white balance properly.  
Also, it may not be possible to compensate the white balance properly depending on the lighting conditions.

### Setting the black balance

The black balance needs to be adjusted when using a remote camera for the first time or when a remote camera has not been used for a prolonged period of time.

It also needs to be adjusted when significant changes have occurred in the ambient temperature or at the change of the seasons.

When the camera will be used with the same settings and under the same conditions, the black balance does not need to be adjusted again. When the black balance is adjusted again, the previous memory data will be erased and replaced with the new black balance settings.

### Automatically adjusting the black balance

1. Press the **ABB** button.

The **ABB** button indicator blinks and the black balance is adjusted by automatically closing the lens iris.

When adjustment ends successfully, the button indicator turns off and the adjustment results are registered.

When adjustment was not possible, the **ABB** button indicator turns on.

- When the black balance is adjusted automatically, the R and B PED setting values return to "±0".

### Manually adjusting the black balance (R and B pedestal adjustment)

1. Connect the video output of the currently selected remote camera to a waveform monitor.
2. Press the **auto iris** button to turn its indicator off.
3. Turn the **IRIS** dial to close the lens iris.
4. Turn the **R PED** dial to select the R channel (red) setting, and turn the **B PED** dial to select the B channel (blue) setting.
  - The setting value is displayed during adjustment.
  - When the R PED dial and B PED dial are pressed, the setting values do not change and are only displayed.

|         |      |
|---------|------|
| R PED : | +150 |
| B PED : | +150 |

## Selecting the color bars

Press the BARS button to output color bar signals from the remote camera.

**Button indicator off:** Outputs the signal for the images shot by the camera

**Button indicator on:** Outputs the color bar signal

## Setting the detail

The image detail (image sharpness) can be adjusted.

### 1. Press the **DETAIL** button.

The current detail setting appears.



### 2. Turn the F1 dial and F2 dial to select settings.

## Adjusting the shutter speed

The shutter mode and shutter speed of a remote camera can be selected.

### 1. Press the **MENU** button to turn on its indicator.

### 2. Open **SHUTTER** menu [21].

## Setting the shutter mode

### 3. Turn the F1 dial to display the “1. SHUTTER” item.



### 4. Turn the F2 dial to select the shutter mode, and then press the F2 dial to confirm the selection.

**Off** : Turns off the electronic shutter.

**Step** : Operates the shutter at the shutter speed set in the “2. SPEED” item.

**Synchro** : Operates the shutter at the shutter speed set for the remote camera.

Set the shutter speed value for synchro mode in the OSD menu of the remote camera.

For details, refer to the Operating Instructions for the remote camera.

**ELC** : Controls the electronic shutter and automatically adjusts the light quantity.

- The shutter mode settings differ depending on the remote camera connected. Check the Operating Instructions for the corresponding model.

## Setting the shutter speed

When “Step” has been selected as the shutter mode, you can specify the shutter speed.

### 5. Turn the F1 dial to display the “2. SPEED” item.



### 6. Turn the F2 dial to adjust the shutter speed.

- The shutter speed settings differ depending on the remote camera connected. Check the Operating Instructions for the corresponding model.

#### Note

- For a remote camera connected via a serial connection, when you change the camera group once and then return to the original camera group, the shutter speed is set to “1/100”.

## Setting the shooting mode (SCENE 1 to SCENE 4)

Change the shooting mode (scene file) of the remote camera to match the shooting conditions. Use the SCENE 1 to SCENE 4 buttons to change the shooting mode.

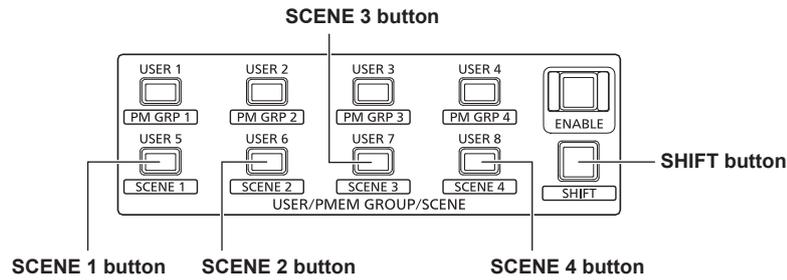

1. Press the SHIFT button to turn on its indicator.

2. Press one of the SCENE 1 to SCENE 4 buttons.

The indicator of the pressed button turns on and the shooting mode changes.

● The names of shooting modes and operation of each mode differ depending on the model of remote camera. For details, refer to the Operating Instructions for the remote camera.

The following shows the relationship between the SCENE 1 to SCENE 4 buttons on the unit and the shooting modes of the remote camera.

| Button on unit | Remote camera shooting mode |                    |                        |             |  |
|----------------|-----------------------------|--------------------|------------------------|-------------|--|
|                | AW-HE120                    | AW-HE60<br>AW-HE50 | AK-HC1500<br>AK-HC1800 | AW-HE100    | AW-HE870<br>AW-E860<br>AW-E750<br>AW-E650<br>AW-E350 |
| SCENE 1        | Scene1                      | Manual1            | CURRENT                | Halogen     | Halogen  |
| SCENE 2        | Scene2                      | Manual2            | PRESET                 | Fluorescent | Fluorescent  |
| SCENE 3        | Scene3                      | Manual3            | USER1                  | Daylight    | Outdoor  |
| SCENE 4        | Scene4                      | FullAuto           | USER2                  | User        | User   |

## Setting an ND filter

The ND filter setting can be configured when the selected remote camera has a built-in ND filter.

1. Press the **MENU** button to turn on its indicator.
2. Open **ND FILTER** menu [22].

1 . ND FILTER  
ND1↓

3. Turn the **F2** dial to select a setting, and then press the **F2** dial to confirm the selection.

The settings displayed when you turn the F2 dial differ depending on the model of remote camera connected.

The following shows the menu display on the unit and the setting values of the remote cameras.

| Menu display on the unit | Remote camera setting values |                        |   |
|--------------------------|------------------------------|------------------------|---|
|                          | AW-HE120                     | AK-HC1500<br>AK-HC1800 | AW-HE50<br>AW-HE60<br>AW-HE100<br>AW-HE870<br>AW-E860<br>AW-E750<br>AW-E650<br>AW-E350<br>(*) |
| <b>ND1</b>               | Through                      | Clear                  | —   |
| <b>ND2</b>               | 1/4                          | 1/4                    | —   |
| <b>ND3</b>               | 1/16                         | 1/16                   | —   |
| <b>ND4</b>               | 1/64                         | 1/64                   | —   |

(\*) “ND2↓”, “ND3↓”, and “ND4↓” can be displayed by turning the F2 dial but a selection cannot be confirmed by pressing the dial.

## Selecting an ND filter with the USER buttons (USER 1 to USER 8)

The ND filter settings “ND1” to “ND4” can be assigned to the USER buttons (USER 1 to USER 8) to enable selection with the buttons.  
⇒ “Assigning functions to the USER buttons” (page 30)

1. Press one of the **USER** buttons (USER 1 to USER 8).

The indicator of the selected button turns on and the corresponding ND filter is applied.

# Operating the OSD menu of a remote camera

To set the advanced settings of a remote camera, operate the menu superimposed on the image output of the remote camera (this menu is referred to as the OSD menu in this manual). The OSD menu of a connected remote camera can be operated from the unit.

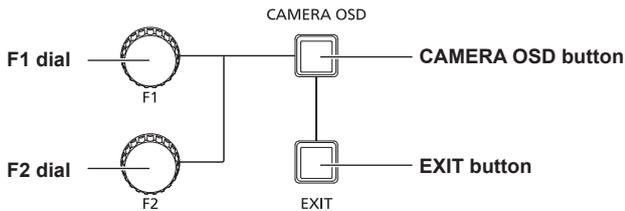

## 1. Hold down the CAMERA OSD button to turn on its indicator.

The OSD menu of the selected remote camera appears and becomes able to be operated from the unit.

## 2. Operate the OSD menu.

Use the F1 dial, F2 dial, and EXIT button to operate the OSD menu.

Operation differs depending on the model connected.

### <Table of operations>

| Remote camera  | Dial/button operation  | OSD menu operation   |
|--|------------------------|--|
| AW-HE50<br>AW-HE60<br>AW-HE120                       | Turn the F1 dial.      | <ul style="list-style-type: none"> <li>● Moves the items (*1).</li> <li>● Selects a setting (*2).</li> </ul>                       |
|  | Press the F1 dial.     | Confirms the change to the selected setting.   |
|  | Press the EXIT button. | Cancel the selected setting.   |
| AK-HC1500<br>AK-HC1800<br>AW-HE870                   | Turn the F1 dial.      | <ul style="list-style-type: none"> <li>● Moves the items (*1).</li> <li>● Selects a setting (*2).</li> </ul>                       |
|  | Press the F1 dial.     | Confirms the change to the selected setting.   |
| AW-E350<br>AW-E650<br>AW-E750<br>AW-E860<br>AW-HE100 | Turn the F1 dial.      | Moves the items (*1).  |
|  | Press the F1 dial.     | Confirms the sub-menu selection.   |
|  | Turn the F2 dial.      | <ul style="list-style-type: none"> <li>● Changes the setting directly (*3).</li> <li>● Confirms the sub-menu selection.</li> </ul> |

(\*1) Turn clockwise : Moves the items down.

Turn counterclockwise : Moves the items up.

(\*2) Turn clockwise : Changes the setting in the plus (+) direction.

Turn counterclockwise : Changes the setting in the minus (-) direction.

(\*3) Turning the dial changes the setting and instantaneously reflects the new value on the remote camera.

Turn clockwise : Changes the setting in the plus (+) direction and confirms the value.

Turn counterclockwise : Changes the setting in the minus (-) direction and confirms the value.

## 3. Hold down the CAMERA OSD button to turn off its indicator.

The menus of the unit become able to be operated.

### Notes

- When the unit is operating the OSD menu of a remote camera, the CAMERA OSD button lighting state and OSD menu display state may no longer match and OSD menu operation may not be able to be performed properly if the OSD menu OFF operation is performed for the same remote camera from, for example, another remote camera controller or a wireless remote controller. In such a case, hold down the CAMERA OSD button on the unit, and after the CAMERA OSD button lighting state (off) and OSD menu display state (OSD menu hidden) match, hold down the CAMERA OSD button again and then perform the operation.
- If a camera selection button [CAMERA SELECT/GROUP SELECT] is pressed to switch to another remote camera to control from the unit during the display of the OSD menu of a remote camera, the OSD menu of the remote camera that was selected disappears.
- For details on the menu items that are displayed, check the Operating Instructions for the corresponding model.

# Operating preset memory (PMEM)

The preset memory of a remote camera can be operated from the unit. The following settings that you have adjusted in advance can be stored in preset memory.

- Pan/tilt positions
- Lens iris settings (manual iris only)
- Zoom positions
- White balance settings
- Focus positions
- Gain

## Notes

- If the MEM ENABLE button indicator is off, preset memory operation is not possible. Press the button to turn on its indicator and then perform operation.
- Preset numbers PMEM 1 to 10 are also used as start positions when recalling tracing memory. Preset data may be overwritten by tracing memory operation.
- The number of preset memory that can be registered differs depending on the remote camera. For details, check the Operating Instructions for the corresponding model.
- The white balance setting and gain are registered to only the preset memory of AW-HE50, AW-HE60, and AW-HE120. The white balance setting that is registered is that which results from application of manual R/B gain adjustment to the automatic white balance adjustment. When the preset memory is recalled, the same color tones as at the time of registration are reproduced but the R/B gain values become 0.

## ● Changing pages

Press one of the number buttons [1] to [50] to directly select any of the 50 preset memory. Furthermore, pressing the PMEM PAGE button to change pages allows you to operate up to 100 preset memory for each camera.

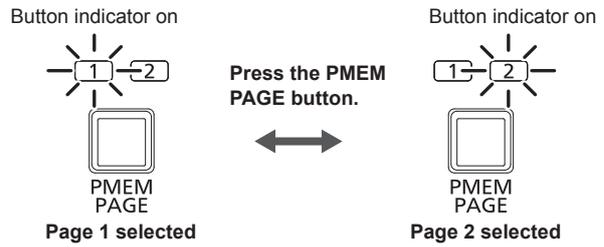

### <Preset numbers and registered pages>

| Preset number       | Page number | Number button |
|---------------------|-------------|---------------|
| PMEM 1 to PMEM 50   | Page 1      | [1] to [50]   |
| PMEM 51 to PMEM 100 | Page 2      |               |

Example: When specifying preset number "PMEM 51"

1. Press the PMEM PAGE button to select Page 2.
2. Press number button [1].

## ● Lighting of number button indicators

The lighting method of the number buttons differs depending on the remote camera or pan-tilt head that the unit is controlling.

### <Lighting method of number button indicators>

| Remote cameras and pan-tilt heads                | Lighting method of number button indicators   |
|--|---|
| AW-HE50, AW-HE60, AW-HE120                       | The indicators of the number buttons with preset memory registered turn on.   |
| AW-HE100, AW-PH360, AW-PH405, AW-PH650, AW-PH400 | The indicator of the number button that was last pressed turns on. However, when preset memory is deleted in DELETE mode, all of the number buttons turn off. |

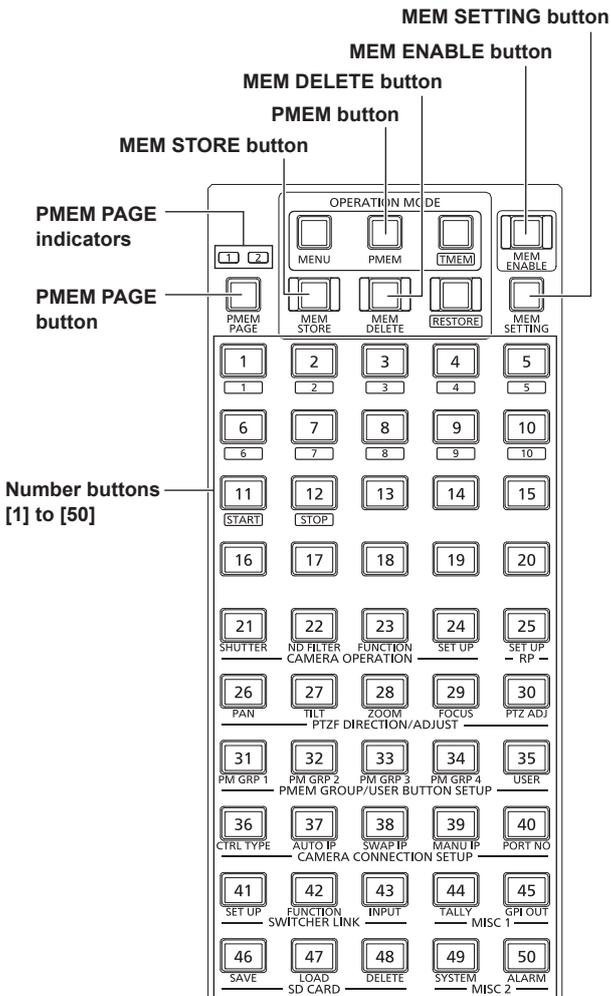

## Registering preset memory (STORE)

1. Press one of the camera selection buttons [CAMERA SELECT/GROUP SELECT] to select the remote camera to be operated.
2. Output the images to be shot to the monitor.
3. Press the PMEM button to turn on its indicator.
4. Press the MEM STORE button to turn on its indicator.
5. Operate the PAN/TILT lever and ZOOM button to determine the camera angle to register.  
If necessary, adjust the focus and iris as well.
6. Hold down a number button to specify the preset number to register.  
"STORE COMPLETE" appears on the second line of the LCD panel. The current camera positions and settings are registered to the preset memory of the remote camera.
  - To continue registering different camera angles to a preset memory belonging to the same "page number", repeat steps 5 to 6.

### Notes

- When registering preset memory, hold down the number button.
- If a number button that already has preset memory registered is held down, the saved data will be deleted as it will be overwritten.  
However, if a number button that already has tracing memory registered is held down, "Used by TMEM." will be displayed on the LCD panel and the corresponding preset memory data will not be overwritten.

## Recalling preset memory (RECALL)

1. Press one of the camera selection buttons [CAMERA SELECT/GROUP SELECT] to select the remote camera to be operated.
2. Press the PMEM button to turn on its indicator.
3. Hold down a number button to specify the preset number to recall.  
The registered settings are recalled.
  - When the indicator of the MEM STORE button or MEM DELETE button is on, preset memory is not recalled when a number button is pressed.  
Press the PMEM button or press the MEM STORE button or MEM DELETE button with the indicator turned on to turn off its indicator, and then perform the operation.

## Deleting preset memory (DELETE)

1. Press one of the camera selection buttons [CAMERA SELECT/GROUP SELECT] to select the remote camera to be operated.
2. Press the PMEM button to turn on its indicator.
3. Press the MEM DELETE button to turn on its indicator.
4. Hold down a number button to specify the preset number to delete.  
"DELETE COMPLETE" appears on the second line of the LCD panel and the registered settings are deleted.

### Notes

- When deleting preset memory, hold down the number button.
- When the preset number used with tracing memory is held down, "Used by TMEM." will be displayed on the LCD panel and the corresponding preset memory data will not be deleted.  
⇒ For details on tracing memory, refer to "Deleting tracing memory (DELETE)" (page 20).
- If the above operation is performed when controlling AW-PH400 (connected via AW-IF400), "DELETE COMPLETE" is displayed on the LCD panel but deletion of the preset memory is not executed and the registered settings are retained.

## Setting the operation items for when preset memory is recalled (PRESET SCOPE)

You can select whether to recall all or only some of the settings registered to preset memory.

### Note

- This function is enabled when AW-HE50, AW-HE60, or AW-HE120 is selected.

1. Press one of the camera selection buttons [CAMERA SELECT/GROUP SELECT] to select the remote camera to be operated.

2. Press the PMEM button to turn on its indicator.

3. Press the MEM SETTING button.

The setting of the selected remote camera is displayed.

SPEED : 30↓  
SCOPE : MODE A↓

- If approximately 3 seconds elapses without an operation being performed, the previous LCD panel display is redisplayed.

4. Turn the F2 dial to select a setting for the “SCOPE” item from MODE A to MODE C, and then press the F2 dial to confirm the selection.

The setting of the remote camera is changed.

This is applied the next time the preset memory is recalled.

### <SCOPE settings and recalled items>

| Setting | Recalled item              |      |                              |
|---------|----------------------------|------|------------------------------|
|         | Pan, tilt, zoom, and focus | Iris | White balance settings, Gain |
| MODE A  | √                          | √    | √                            |
| MODE B  | √                          | √    | —                            |
| MODE C  | √                          | —    | —                            |

√: Recalled —: Not recalled

### Note

- MODE A to MODE C are not registered to the remote camera preset memory or the unit. The settings become the common settings for when preset memory is recalled, and the same settings are applied regardless of which preset number is selected.

## Setting the speed at which to move to the position set in the preset memory (PRESET SPEED)

The speed (PRESET SPEED) at which to move to the set position when preset memory is recalled can be set from the unit.

With this unit, you can select from the following two PRESET SPEED recall modes.

- Move at the common PRESET SPEED set for the remote cameras.
- Move at the PRESET SPEED registered for each preset number of the unit.

This allows the remote cameras to be operated at a different speed for each preset number depending on operation, enabling video playback at a variety of speeds.

### Note

- The movement speeds registered in the procedure below are registered to the corresponding camera numbers in the unit, and are not registered to the preset memory of the remote cameras. Therefore, if the recall mode is set to “On” and the preset memory is recalled on a controller other than the AW-RP120 on which the movement speed was registered, movement will be at a different speed even in the case of the same preset number.

## Setting PRESET SPEED on remote cameras

1. Press one of the camera selection buttons [CAMERA SELECT/GROUP SELECT] to select the remote camera to be operated.

2. Press the PMEM button to turn on its indicator.

3. Press the MEM SETTING button.

The setting of the selected remote camera is displayed.

SPEED : 30↓  
SCOPE : MODE A↓

- If approximately 3 seconds elapses without an operation being performed, the previous LCD panel display is redisplayed.

### Note

- When a remote camera other than AW-HE50, AW-HE60, or AW-HE120 is controlled, the last value set for the corresponding remote camera on the unit is displayed.

4. Turn the F1 dial to select the setting of the “SPEED” item, and then press the F1 dial to confirm the selection.

The PRESET SPEED value is set on the remote cameras.

The following shows the relationship between the set value and the speed at which the remote camera moves to the set position when preset memory is recalled.

1 ←————→ 30  
Slow Fast

### Registering PRESET SPEED on the unit

To register the PRESET SPEED value to a preset number of the unit, perform the following steps after the previous procedure.

**5. Press the MEM STORE button to turn on its indicator.**

**6. Hold down a number button to specify the preset number to register.**

The current remote camera settings are registered to preset memory, and PRESET SPEED is registered to the unit.

- To continue registering a different PRESET SPEED value to a preset memory belonging to the same “page number”, repeat steps 3 → 4 → 6.

### Setting the PRESET SPEED recall mode

**1. Press the MENU button to turn on its indicator.**

**2. Open CAMERA SETUP menu [24].**

**3. Turn the F1 dial to display the “3. RECALL PST SPD” item.**



3. RECALL PST SPD  
Off ↓

**4. Turn the F2 dial to select the recall mode, and then press the F2 dial to confirm the selection.**

**Off** : Recalling preset memory moves the remote cameras at the speed of the PRESET SPEED values set on the remote cameras.

**On** : Recalling preset memory moves the remote cameras at the speed of the PRESET SPEED value registered for each preset number on the unit.

# Operating preset memory groups (PMEM GROUP)

The unit allows you register up to four “preset memory groups” created by selecting one preset memory for each of multiple remote cameras. Pressing any of the PM GRP 1 to PM GRP 4 buttons simultaneously recalls all preset memory registered to the corresponding preset memory group.

The following setting procedures use the example of setting PMEM GROUP1 but the setting procedures are the same for PMEM GROUP2 to PMEM GROUP4. Open the following menus and configure the settings.

## <Preset memory groups and menu numbers>

| Preset memory group | Menu              |
|---------------------|-------------------|
| PMEM GROUP1         | PM GRP1 menu [31] |
| PMEM GROUP2         | PM GRP2 menu [32] |
| PMEM GROUP3         | PM GRP3 menu [33] |
| PMEM GROUP4         | PM GRP4 menu [34] |

## Setting the operation mode (SEPARATE/ALL)

1. Press the MENU button to turn on its indicator.

2. Open PM GRP1 menu [31].

1. PM GRP1 MODE  
SEPARATE↓

3. Turn the F1 dial to display the “1. PM GRP1 MODE” item.

4. Turn the F2 dial to select the operation mode, and then press the F2 dial to confirm the selection.

- OFF** : Disables group creation.  
Even if you press any of the PM GRP1 to PM GRP4 buttons, a preset memory group will not be recalled.
- SEPARATE** : Allows you to create a group by selecting a different preset number from each remote camera.  
Up to ten preset numbers can be registered to one group.
- ALL** : Allows you to create a group by selecting the same preset number from each remote camera.  
One preset number for each of all the remote cameras registered to the unit can be registered to one group.

## Creating preset memory groups

### Registering the preset memory to recall when in SEPARATE mode

1. Press the MENU button to turn on its indicator.

2. Open PM GRP1 menu [31].

1. PM GRP1 MODE  
SEPARATE↓

3. Turn the F1 dial to display the “2. PM GRP1 1/10” item.

2. PM GRP1 1/10  
NoAsgn↓ -----

4. Turn the F2 dial to set the camera number and preset number to register to PMEM GROUP1.

If you turn the F2 dial to select the camera number and then press the F2 dial to confirm the selection, you will then be able to select the preset number.

Set the preset number in the same way as the camera number.

2. PM GRP1 1/10  
CAM001↓ PRE001

Camera number      Preset number

**Camera number** : Select from NoAsgn and CAM001 to CAM100.  
When “NoAsgn” is set, preset memory is not registered.

**Preset number** : Select from PRE001 to PRE100.

5. Turn the F1 dial to display the “3. PM GRP1 2/10” to “11. PM GRP1 10/10” items.

6. Register the camera numbers and preset numbers.

- Configure the settings in the same way as step 4.
- Up to ten preset memory can be registered to one group.

#### Note

- Do not set the same camera number two or more times for one preset memory group.

**Registering the preset memory to recall when in ALL mode**

1. Press the MENU button to turn on its indicator.

2. Open PM GRP1 menu [31].



3. Turn the F1 dial to display the "12. PM GRP1 ALL" item.



4. Turn the F2 dial to select a preset number, and then press the F2 dial to confirm the selection.

**Recalling preset memory groups**

**Pressing a button to recall a preset memory group**

Use PM GRP 1 to PM GRP 4 to recall preset memory groups.

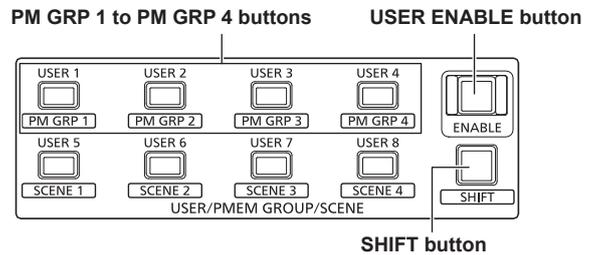

1. Press the SHIFT button to turn on its indicator.

2. Press the PM GRP 1 button.

**When the operation mode of PMEM GROUP1 is "SEPARATE":**

Simultaneously recalls each remote camera preset memory registered to the "2. PM GRP1 1/10" to "11. PM GRP1 10/10" items.

**When the operation mode of PMEM GROUP1 is "ALL":**

The preset memory registered in the "12. PM GRP1 ALL" item is recalled for all of the remote cameras registered to the unit.

- Preset memory is not recalled for a remote camera for which "NoAssign" is set in CTRL TYPE menu [36].

**Note**

- If the USER ENABLE button indicator is off, operation of the PM GRP 1 to PM GRP 4 buttons is not possible. Perform operation while the button indicator is on.

**Recalling a preset memory group by GPI input**

A preset memory group can be recalled by contact input of the TALLY/ GPI connector on the rear panel of the unit.

**<PIN numbers and preset memory groups>**

| Pin number | Signal name | Corresponding preset memory group |
|------------|-------------|-----------------------------------|
| 19         | GPI IN 1    | PMEM GROUP 1                      |
| 7          | GPI IN 2    | PMEM GROUP 2                      |
| 20         | GPI IN 3    | PMEM GROUP 3                      |
| 8          | GPI IN 4    | PMEM GROUP 4                      |

⇒ "Control interface for external devices" (page 43)

# Operating tracing memory (TMEM)

The unit incorporates tracing memory (TMEM) for recording a series of operations that were performed for a connected remote camera. This feature allows you to duplicate the recorded operations of a remote camera.

## <Tracing memory>

|                                       |  |
|---------------------------------------|--|
| <b>Recording target</b>               | Camera numbers CAM1 to CAM10                         |
| <b>Functions that can be recorded</b> | Pan, tilt, zoom, focus, iris, and white balance mode |
| <b>Recording time</b>                 | Up to 5 minutes per camera                           |
| <b>Number of recording memory</b>     | Up to 10 per camera                                  |
| <b>Record buttons</b>                 | Number buttons [1] to [10]                           |

### Notes

- If the MEM ENABLE button indicator is off, tracing memory operation is not possible. Perform operation while the button indicator is on.
- Preset numbers PMEM 1 to 10 of the preset memory are used as start positions at the time of recalling tracing memory so they are overwritten when the tracing memory registration operation is performed.
- The last point when tracing memory is recalled may not match that at the time of recording because of the error of movement of the remote camera.  
Taking precautions such as the following can help reduce the error.
  - Use the lens zoom at the WIDE side (wide-angle end).
  - Perform pan, tilt, zoom, and focus operations slowly.
  - Set a short recording time.
 Execute tracing memory recalling several times to sufficiently check the operation of the remote camera before you begin operation.

## <Tracing memory operation section>

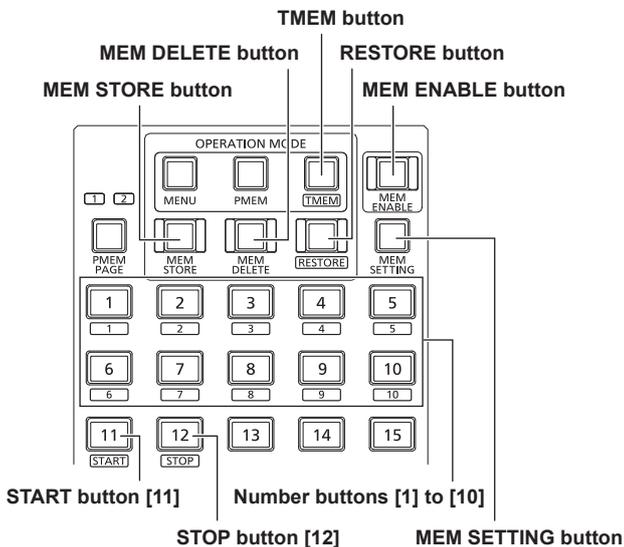

## Registering tracing memory (STORE)

1. Press one of the camera selection buttons [CAMERA SELECT/GROUP SELECT] to select the remote camera to be operated.
2. Output the images to be shot to the monitor.
3. Press the TMEM button to turn on its indicator.  
The tracing memory status appears.  
The indicators of number buttons with registered tracing memory turn on.

Selected camera number

CAM01:TMEM  
3m50s Remained.

Remaining possible recording time (max. 5 m 00 s)

### Note

- A button with no tracing memory registered does not turn on even when it is a button with preset memory registered.

4. Press the MEM STORE button to turn on its indicator.

5. Operate the PAN/TILT lever and ZOOM button to determine the camera angle to register.

If necessary, adjust the focus, iris, and white balance as well.

- To record the focus operation and iris operation to tracing memory, press the auto focus button and auto iris button to turn off their indicators and then perform the operations.

**6. Hold down one of the number buttons [1] to [10] that has its indicator turned off to specify the tracing memory number.**

The current camera position and settings are registered to the preset memory of the remote camera, and become the start position and settings at the time of recalling.

The indicators of the number button that was held down and START button [11] blink. (Recording standby state)

- If an operation that is target for recording such as moving the PAN/TILT lever is performed at that time, the recording standby state is canceled and the status returns to that of step 3.

Tracing memory number

TM05:  
Standby Store

**Notes**

- If you want to register tracing memory to a button whose indicator is on, delete the registered tracing memory and then register the new tracing memory.
- If a button with the same number as a registered preset memory is held down, the saved preset memory will be deleted as it will be overwritten.

**7. Press START button [11].**

The indicator of START button [11] turns on. (Operation wait state)

TM05:  
Waiting Opr.

**8. Operate one of the PAN/TILT lever, ZOOM button, FOCUS dial, IRIS dial, and white balance mode selection buttons.**

The recording of tracing memory starts from the point in time that the operation began.

Recording time

TM05:0m02s  
Storing...

**9. Press STOP button [12].**

Recording stops and the tracing memory is saved.

The registered number button turns on and the status returns to that of step 3.

- When the possible recording time elapses, recording stops automatically.
- At that time, operations up until the point in time that recording stops are recorded.

**Recalling tracing memory (RECALL)**

**1. Press one of the camera selection buttons [CAMERA SELECT/GROUP SELECT] to select the remote camera to be operated.**

The tracing memory status appears.

**2. Press the TMEM button to turn on its indicator.**

The tracing memory status appears.

The indicators of number buttons with registered tracing memory turn on.

Selected camera number

CAM01:TMEM  
3m50s Remained.

Remaining possible recording time (max. 5 m 00 s)

**Note**

- A button with no tracing memory registered does not turn on even when it is a button with preset memory registered.

**3. Press one of the number buttons that has its indicator turned on to specify the tracing memory number.**

The remote camera moves to the start position.

The indicators of the number button that was pressed and START button [11] blink. (Recall standby state)

TM03:0m00s/0m59s  
Standby Recall

**4. Press START button [11].**

The tracing memory is recalled and the remote camera starts moving.

The indicator of START button [11] turns on.

Tracing memory number      Current recall position      Total time of tracing memory during recalling

TM03:0m20s/0m59s  
Recalling...

**5. When the recording time elapses, the remote camera stops automatically.**

The number button that was blinking turns on, the indicator of START button [11] turns off, and the process returns to step 2.

- Pressing the STOP button [12] or performing an operation that is target for recording such as moving the PAN/TILT lever during recalling will stop recalling and return the process to step 2.

## Deleting tracing memory (DELETE)

1. Press one of the camera selection buttons [CAMERA SELECT/GROUP SELECT] to select the remote camera to be operated.
2. Press the TMEM button to turn on its indicator.  
The tracing memory status appears.  
The indicators of number buttons with registered tracing memory turn on.



### Note

- A button with no tracing memory registered does not turn on even when it is a button with preset memory registered.

3. Press the MEM DELETE button to turn on its indicator.
4. Hold down one of the number buttons [1] to [10] that has its indicator turned on to specify the tracing memory number.  
The registered preset memory (start position) and tracing memory are deleted.

## Restoring tracing memory (RESTORE)

Some of the recorded tracing memory data can be overwritten. For example, you can record just the ZOOM operation again while leaving the data recorded for the PAN/TILT operation as is. Or you can leave the data for the first half of the recorded PAN/TILT operation as is and record just the second half of the operation again.

- It is not possible to correct just an arbitrary section of recorded tracing memory data.

1. Press one of the camera selection buttons [CAMERA SELECT/GROUP SELECT] to select the remote camera to be controlled from the unit.
2. Output the images to be shot to the monitor.
3. Press the TMEM button to turn on its indicator.  
The tracing memory status appears.  
The indicators of number buttons with registered tracing memory turn on.



### Note

- A button with no tracing memory registered does not turn on even when it is a button with preset memory registered.

4. Press the RESTORE button to turn on its indicator.
  5. Press one of the number buttons [1] to [10] that has its indicator turned on.  
The remote camera moves to the start position.  
The indicators of the number button that was pressed and START button [11] blink. (Restore standby state)
- At this time, you can operate the PAN/TILT lever to change the start position.

TM03 : 0m00s/0m50s  
Standby Restore

**6. Press START button [11].**

The tracing memory is recalled and the remote camera starts moving.

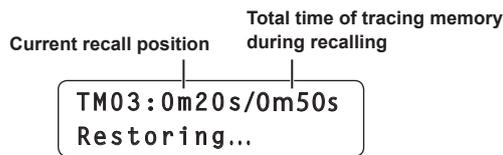

**7. Operate one of the PAN/TILT lever, ZOOM button, FOCUS dial, IRIS dial, and white balance mode selection buttons to make a correction.**

Overwriting is performed from the point in time that the correction operation is performed.

**Note**

- It is not possible to correct just an arbitrary section of recorded tracing memory data. The registered data is deleted from the point in time that the operation is performed so continue the operation until the recording time ends to register the new data.

**8. When the recording time elapses, the remote camera stops automatically.**

The process returns to step 3.

- When STOP button [12] is pressed during recalling, recalling stops. The total time of the tracing memory changes, and the process returns to step 3.

**Setting the items to recall when recalling tracing memory**

You can select whether to recall all or only some of the items registered to tracing memory.

**Note**

- This function is enabled when AW-HE50, AW-HE60, or AW-HE120 is selected.

**1. Press the MEM SETTING button.**

The current setting appears.

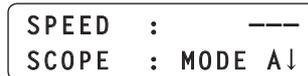

- If approximately 3 seconds elapses without an operation being performed, the previous LCD panel display is redisplayed.

**2. Turn the F2 dial to select a setting for the “SCOPE” item from MODE A to MODE C, and then press the F2 dial to confirm the selection.**

The setting of the unit is changed.

This is applied the next time the tracing memory is recalled.

**<SCOPE settings and recalled items>**

| Setting | Recalled item              |      |                    |
|---------|----------------------------|------|--------------------|
|         | Pan, tilt, zoom, and focus | Iris | White balance mode |
| MODE A  | √                          | √    | √                  |
| MODE B  | √                          | √    | —                  |
| MODE C  | √                          | —    | —                  |

√: Recalled —: Not recalled

When the operation is performed, the PRESET SCOPE setting of the remote camera is changed to the same setting as well at the same time.

⇒ “Setting the operation items for when preset memory is recalled (PRESET SCOPE)” (page 14)

# Configuring the remote camera operation settings

## Adjusting the operation speed of the pan, tilt, zoom, and focus

The dedicated dials can be used to individually adjust the operation speed of the remote camera for each of the PAN/TILT lever, ZOOM button, and FOCUS dial operations performed with the unit.

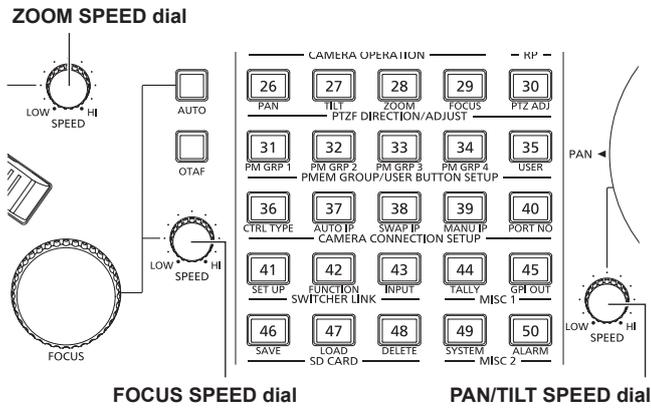

### ■ Operation of SPEED dial

- Turned clockwise : Operation is at a higher speed (HI)
- Turned counterclockwise : Operation is at a lower speed (LOW)

## Setting the PAN/TILT lever inclination and speed

The correlation between the angle and operating speed when the PAN/TILT lever is inclined can be adjusted.

1. Press the MENU button.
2. Open RP SETUP menu [25].
3. Turn the F1 dial to display the "2. P/T CURV" item.



4. Turn the F2 dial to select a setting, and then press the F2 dial to confirm the selection.

- The higher the value selected, the slower the operation when the lever begins to be moved.

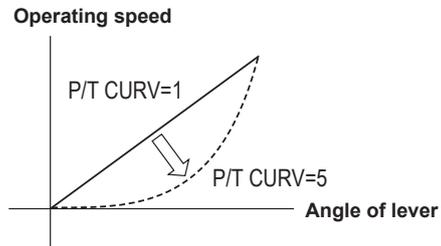

### Setting the pan, tilt, zoom, and focus operation directions

You can set the direction that a remote camera moves in response to the operation of the PAN/TILT lever, ZOOM button, and FOCUS dial. With this unit, you can set the direction for each camera number.

#### Setting the panning direction

Set the operation of the remote camera in the horizontal direction in response to the horizontal operation of the PAN/TILT lever.

1. Press the MENU button.
2. Open PAN DIRECTION menu [26].
3. Turn the F1 dial to display the camera number for which to configure the setting.

1 . CAM1  
NORMAL ↓

4. Turn the F2 dial to select “NORMAL” or “REVERSE”, and then press the F2 dial to confirm the selection.

**NORMAL** : The remote camera moves to the left when the PAN/TILT lever is moved toward the left, and to the right when the lever is moved toward the right.

**REVERSE** : Operation is in the opposite direction to NORMAL.

#### Setting the tilting direction

Set the operation of the remote camera in the vertical direction in response to forward and backward operation of the PAN/TILT lever.

1. Press the MENU button.
2. Open TILT DIRECTION menu [27].
3. Turn the F1 dial to display the camera number for which to configure the setting.

1 . CAM1  
NORMAL ↓

4. Turn the F2 dial to select “NORMAL” or “REVERSE”, and then press the F2 dial to confirm the selection.

**NORMAL** : The remote camera moves upward when the PAN/TILT lever is moved away from you, and downward when the lever is moved toward you.

**REVERSE** : Operation is in the opposite direction to NORMAL.

#### Setting the zooming direction

Set the zooming operation of the lens in response to the operation of the ZOOM button.

1. Press the MENU button.
2. Open ZOOM DIRECTION menu [28].
3. Turn the F1 dial to display the camera number for which to configure the setting.

1 . CAM1  
NORMAL ↓

4. Turn the F2 dial to select “NORMAL” or “REVERSE”, and then press the F2 dial to confirm the selection.

**NORMAL** : The lens zooms toward the telephoto end when the TELE side of the ZOOM button is pressed, and toward the wide-angle end when the WIDE side is pressed.

**REVERSE** : Operation is in the opposite direction to NORMAL.

### Setting the focusing direction

Set the focusing operation of the lens in response to the operation of the FOCUS dial.

1. Press the MENU button.
2. Open FOCUS DIRECTION menu [29].
3. Turn the F1 dial to display the camera number for which to configure the setting.

1 . CAM1  
NORMAL ↓

4. Turn the F2 dial to select “NORMAL” or “REVERSE”, and then press the F2 dial to confirm the selection.

**NORMAL** : The focus moves toward the far end when the FOCUS dial is turned clockwise, and toward the near end when the dial is turned counterclockwise.

**REVERSE**: Operation is in the opposite direction to NORMAL.

### Setting the minimum lens zoom start speed

Correct the zoom control amount to send from the unit so that the lens zoom starts to move smoothly when the ZOOM button is pressed in slowly.

1. Press the MENU button.
2. Open PTZ ADJUST menu [30].
3. Turn the F1 dial to display the “1. Z MIN SPEED” item.

1 . Z MIN SPEED  
Off ↓

4. Turn the F2 dial to select the correction amount, and then press the F2 dial to confirm the selection.

- The lowest correction amount is “1”, and the highest is “8”. No correction is made with the “Off” setting.

While observing the images on a monitor, press the ZOOM button slowly and check whether the lens zoom starts moving smoothly.

### Setting the speed of the pan and tilt operations for telephoto shooting

During telephoto shooting, the remote camera’s pan and tilt operations are slowed down to make positioning easier.

1. Press the MENU button.
2. Open PTZ ADJUST menu [30].
3. Turn the F1 dial to display the “2. SPEED WITH Z” item.

2 . SPEED WITH Z  
Off ↓

4. Turn the F2 dial to select “On” or “Off”, and then press the F2 dial to confirm the selection.

**On** : The pan and tilt operations during telephoto shooting are slow.  
**Off** : Movement is at normal speed.

#### Note

- This function is enabled when AW-HE50, AW-HE60, or AW-HE120 is connected.

### Setting the movement ranges (limiter function) of a remote camera

Depending on the installation location, there may be an obstruction in a movement range of a remote camera, and the remote camera may come into contact with that obstruction when the pan or tilt operation is performed.

A malfunction or accident may occur if the remote camera comes into contact with the obstruction so you need to set a limiter in front of the obstruction to prevent contact.

Also set a limiter if there is a subject you do not wish to shoot in a movement range.

From the unit, you can configure the remote camera limiter setting for the direction of each of the up, down, left, and right limits.

#### Setting procedure

1. Press the MENU button.
2. Open PTZ ADJUST menu [30].
3. Turn the F1 dial to display the "3. LIMIT UP" item.

#### ■ When AW-HE50, AW-HE60, or AW-HE120:

4. Turn the F2 dial to select "On", and then press the F2 dial to confirm the selection.

The position in the up direction of the currently selected remote camera is set as the up limit and the limiter is enabled. (The setting is stored in the remote camera.)

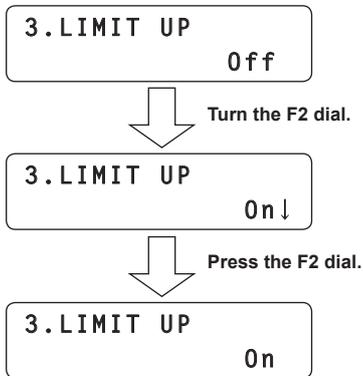

- Turning the F2 dial to display "Off↓" and then pressing the F2 dial to confirm the selection cancels the limiter.

#### ■ When other remote camera

4. Press the F2 dial to confirm the setting.

The position in the up direction of the currently selected remote camera is set as the up limit and the limiter is enabled. (The setting is stored in the remote camera.)

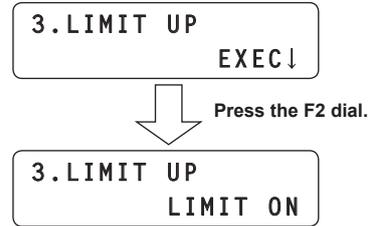

- If the F2 dial is turned or the F1 dial is turned to display another item and then the "3. LIMIT UP" item is redisplayed, "EXEC ↓" reappears on the second line of the LCD panel. If the F2 dial is pressed at this time, "LIMIT OFF" is displayed and the limiter is canceled.

5. Turn the F1 dial to display the "4. LIMIT DOWN", "5. LIMIT LEFT", or "6. LIMIT RIGHT" item. Perform the same operation as step 4 to set the down limit, left limit, and right limit.

| Menu item   | Setting target |
|-------------|----------------|
| LIMIT UP    | Up limit       |
| LIMIT DOWN  | Down limit     |
| LIMIT LEFT  | Left limit     |
| LIMIT RIGHT | Right limit    |

### Returning a remote cameras to its home position

Move a remote camera to the home position stored in advance on the camera.

#### Note

- The position stored as the home position on the remote camera cannot be changed.

1. Press the MENU button.
2. Open CAMERA SETUP menu [24].
3. Turn the F1 dial to display the "5. HOME POSITION" item.



4. Press the F2 dial. The remote camera moves to its home position.

## Controlling the peripheral devices connected to a remote camera

The peripheral devices connected to a remote camera can be controlled. Control the devices with FUNCTION menu [23].

1. Press the MENU button.
2. Open FUNCTION menu [23].

### Controlling an AW-PS300A AC adapter

When an AW-PH360 is being controlled with the unit, you can control an AW-PS300A AC adapter via the AW-PH360.

- For details on how to connect the AW-PH360 and AW-PS300A, refer to the Operating Instructions for each device.

#### ■ Controlling an option switch control output terminal

The short circuiting and open circuiting of the option switch control output terminal [OPTION SW CONTROL OUT] of the AW-PS300A can be controlled.

3. Turn the F1 dial to display the "1. OPTION" item.



4. Turn the F2 dial to select "Off" or "On", and then press the F2 dial to confirm the selection.

**On** : Short circuits the OPTION SW CONTROL OUT terminal.

**Off** : Open circuits the OPTION SW CONTROL OUT terminal.

#### Note

- When AW-HE60 is connected, you can switch between normal shooting mode and night mode in the "1. OPTION" item.

**On** : Sets night mode.

**Off** : Sets normal shooting mode.

When the mode is set to night mode, the shining of an infrared light on the subject enables shooting under low illumination which would normally make shooting difficult. Furthermore, the output video becomes black and white.

Also refer to the Operating Instructions for the AW-HE60.

#### ■ Controlling the lamp AC outlet

The ON and OFF of the lamp AC outlet [LAMP AC OUT] of the AW-PS300A can be controlled.

3. Turn the F1 dial to display the "5. LAMP" item.



4. Turn the F2 dial to select "Off" or "On", and then press the F2 dial to confirm the selection.

**On** : Enables the LAMP AC OUT connector.

**Off** : Disables the LAMP AC OUT connector.

## Controlling a defroster

When the selected remote camera is equipped with a defroster function (AW-PH650 + camera), the defroster can be controlled.

3. Turn the F1 dial to display the "2. DEFROSTER" item.

4. Turn the F2 dial to select "Off" or "On", and then press the F2 dial to confirm the selection.



## Controlling a wiper

When the selected remote camera is equipped with a wiper function (AW-PH650 + camera), the wiper can be controlled.

3. Turn the F1 dial to display the "3. WIPER" item.

4. Turn the F2 dial to select "Off" or "On", and then press the F2 dial to confirm the selection.



## Controlling a heater or fan

When the selected remote camera is equipped with a heater or fan function (AW-PH650 + camera), the heater or fan can be controlled.

3. Turn the F1 dial to display the "4. HEATER/FAN" item.

4. Turn the F2 dial to select "Off" or "On", and then press the F2 dial to confirm the selection.



# Configuring the unit operation settings

## Enabling or disabling operation with the ENABLE buttons

The unit has five ENABLE buttons.

Each of the ENABLE buttons can be used to independently enable or disable the corresponding operation shown below.

### Color adjustment ENABLE button

- Operation of color adjustment section

### MEM ENABLE button

- Operation of memory (preset memory and tracing memory)

### USER ENABLE button

- Operation of USER buttons

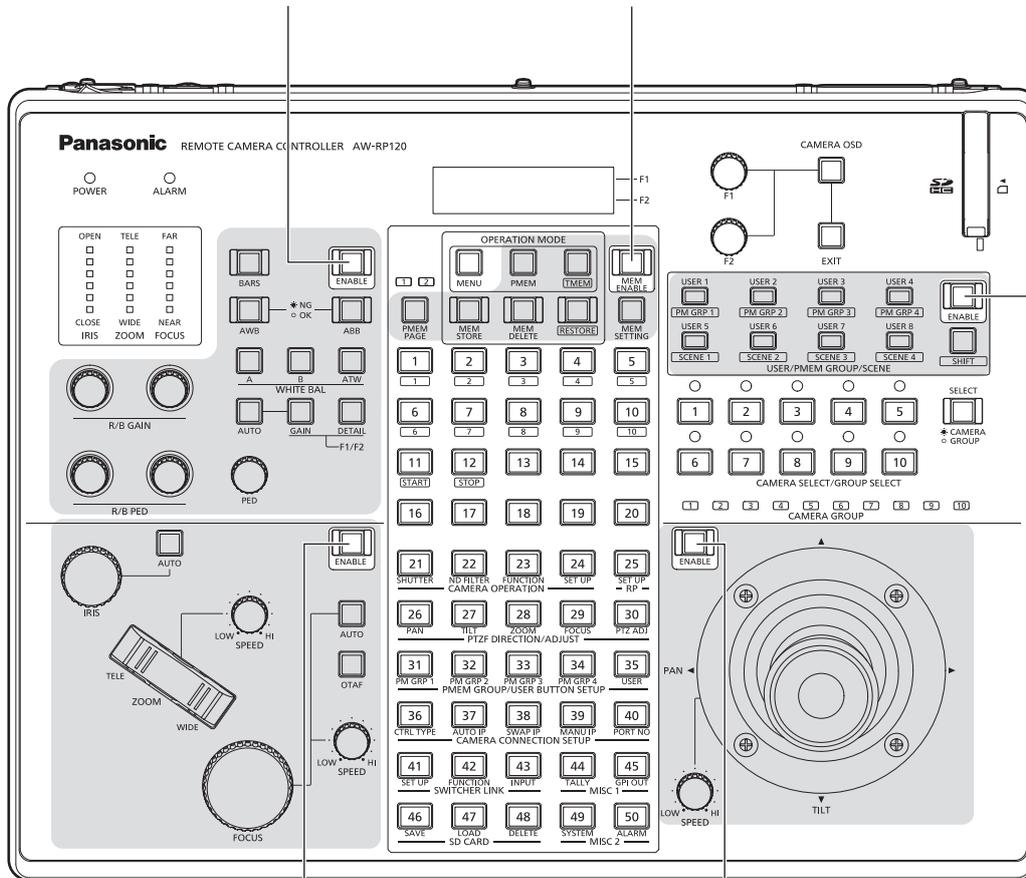

### FOCUS/ZOOM/IRIS ENABLE button

- Operation of FOCUS dial, ZOOM button, and IRIS dial

### PAN/TILT ENABLE button

- Operation of PAN/TILT lever

## 1. Press the ENABLE button.

The button indicator lighting state changes.

**Button indicator on or blinking:** Operation of the corresponding functions are enabled.

**Button indicator off:** Operation of the corresponding functions are disabled.

- Menu operation is possible even when the MEM ENABLE button indicator is off.
- The PAN/TILT ENABLE button indicator blinks while the PAN/TILT lever is being used to operate the switcher.  
⇒ "Operating the switcher with the PAN/TILT lever and ZOOM button" (page 34)
- The FOCUS/ZOOM/IRIS ENABLE button indicator blinks while the ZOOM button is being used to operate the switcher.  
⇒ "Operating the switcher with the PAN/TILT lever and ZOOM button" (page 34)
- When the operation of the ENABLE buttons is disabled by menu operation, operating the ENABLE buttons has no effect.  
⇒ "Enabling or disabling operation of the ENABLE buttons by menu operation" (page 28)

## Enabling or disabling operation of the ENABLE buttons by menu operation

Operation of the ENABLE buttons can be enabled or disabled by menu operation.

Disabling operation prevents erroneous operation because the enable/disable states become unable to be changed even by pressing the ENABLE buttons.

1. Press the MENU button.
2. Open RP SETUP menu [25].
3. Turn the F1 dial to display the “4. ENABLE BUTTON” item.

4. ENABLE BUTTON  
ACTIVE↓

4. Turn the F2 dial to select “ACTIVE” or “LOCK”, and then press the F2 dial to confirm the selection.

**ACTIVE**: Enables operation of the ENABLE buttons.

**LOCK**: Disables operation of the ENABLE buttons.

- Setting this to “LOCK” retains the ENABLE button states (operation is enabled or disabled in accordance with the lighting states), but ENABLE button operation has no effect.

### Memo

- Connecting an external device to the TALLY/GPI connector (GPI input: GPI IN 5) on the rear panel enables the “4. ENABLE BUTTON” item to be controlled from the external device. Each time GPI IN 5 is set to On (30 ms or longer), the setting of the “4. ENABLE BUTTON” item switches between “ACTIVE” and “LOCK”.

## Enabling or disabling menu operation

Menu operation can be enabled or disabled.

### Disabling MENU operation

1. Press the MENU button.
2. Open RP SETUP menu [25].
3. Turn the F1 dial to display the “5. MENU CONTROL” item.
4. Turn the F2 dial to select “LOCK”, and then press the F2 dial to confirm the selection.

5. MENU CONTROL  
LOCK↓



5. MENU CONTROL  
LOCK

Menu operation is disabled.

If a number button with a menu assigned is pressed, “LOCKED!” appears on the LCD panel and the menu does not open.

- Memory (preset memory and tracing memory) operation is still possible even when menu operation is disabled.

### Enabling MENU operation

1. Press the MENU button.  
The following appears on the LCD panel.

5. MENU CONTROL  
LOCK

2. Turn the F2 dial to select “ACTIVE”, and then press the F2 dial to confirm the selection.

Menu operation is enabled.

5. MENU CONTROL  
ACTIVE↓

### Memo

- Connecting an external device to the TALLY/GPI connector (GPI input: GPI IN 6) on the rear panel enables the “5. MENU CONTROL” item to be controlled from the external device. Each time GPI IN 6 is set to On (30 ms or longer), the setting of the “5. MENU CONTROL” item switches between “ACTIVE” and “LOCK”.

## Switching the focus operation and iris operation

The operations of the FOCUS dial and IRIS dial can be switched.

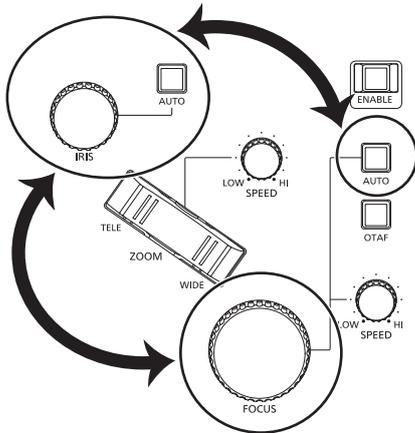

1. Press the MENU button.
2. Open RP SETUP menu [25].
3. Turn the F1 dial to display the “1. FOCUS/IRIS” item.

1. FOCUS/IRIS  
STANDARD↓

4. Turn the F2 dial to select “EXCHANGE” or “STANDARD”, and then press the F2 dial to confirm the selection.

**EXCHANGE** : Switches the operations of the FOCUS dial and IRIS dial.

- When this is set to “EXCHANGE”, the operations of the auto focus button and auto iris button are also switched.  
The one-touch auto focus button is disabled.  
Operation of the FOCUS SPEED dial is disabled.  
(SPEED is fixed to the value set at the time when this setting was changed to EXCHANGE.)

**STANDARD** : Restores the default operations of the FOCUS dial and IRIS dial.

## Setting the LCD panel backlight

The backlight of the LCD panel can be turned on or off. It can also be set to turn off automatically.

1. Press the MENU button.
2. Open RP SETUP menu [25].
3. Turn the F1 dial to display the “3. LCD BACKLIGHT” item.

3. LCD BACKLIGHT  
Off↓

4. Turn the F2 dial to select a setting, and then press the F2 dial to confirm the selection.

**On** : Turns on the backlight.

**Off** : Turns off the backlight.

**60, 120, 180** : Turns off the backlight automatically when the unit has not been operated within the set time (60, 120, or 180 minutes).

The backlight turns off after the time elapses and then turns on again when the unit is operated.

## Assigning functions to the USER buttons

Functions can be assigned to the eight USER buttons (USER 1 to USER 8). This enables you to operate a desired function by simply pressing a USER button (USER 1 or USER 8).

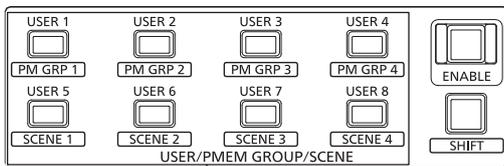

USER buttons (USER 1 to USER 8)

1. Press the MENU button.
2. Open USER BUTTON menu [35].
3. Turn the F1 dial to display the USER button (USER 1 to USER 8) you want to set.
4. Turn the F2 dial to select a function, and then press the F2 dial to confirm the selection.

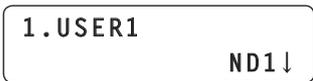

| Functions that can be selected  | Operations when USER buttons pressed   |                                       |            |            |            |
|---|--|---------------------------------------|------------|------------|------------|
| ND1,<br>ND2,<br>ND3,<br>ND4   | Pressing a USER button with a function assigned selects the corresponding ND filter and turns on the button indicator.<br>The selected ND filter value differs depending on the remote camera being controlled.      |                                       |            |            |            |
|   | <b>&lt;Selected ND filter value&gt;</b>  |                                       |            |            |            |
|   |  | <b>Functions that can be assigned</b> |            |            |            |
|   | <b>Remote camera</b>   | <b>ND1</b>                            | <b>ND2</b> | <b>ND3</b> | <b>ND4</b> |
|   | AW-HE120   | Through                               | 1/4        | 1/16       | 1/64       |
| AK-HC1500<br>AK-HC1800  | Clear  | 1/4                                   | 1/16       | 1/64       |            |
| AW-HE100<br>AW-HE60<br>AW-HE50<br>AW-HE870<br>AW-E860<br>AW-E750<br>AW-E650<br>AW-E350                  | —  | —                                     | —          | —          |            |
| — : The remote camera setting is not changed even if a USER button with a function assigned is pressed. |  |                                       |            |            |            |
| SWLINK,<br>BUSCONT,<br>FASSIST,<br>CAMSEL,<br>CAMINF,<br>TALLY_IP                                       | Assign these functions when using the function for linking with a switcher.<br>⇒ "Setting linking with a switcher" (page 31), "Setting the functions for when the unit is linked with the switcher" (pages 32 to 35) |                                       |            |            |            |
| POWER OFF   | Holding down a USER button with the function assigned turns on the indicator of the button for an instant and sends a power-off request to all the connected remote cameras.   |                                       |            |            |            |
| CAM_PINP DISP,<br>CAM_PINP CTL,<br>CAM_PINP POS   | Assign these settings when an AW-HE2 HD integrated camera is connected.<br>⇒ "Operations of AW-HE2" (page 51)  |                                       |            |            |            |

### Note

- When executing the function assigned to a USER button, press the SHIFT button to turn off its indicator and then perform the operation.  
When a USER button is pressed while the SHIFT button indicator is on, either the preset memory group is called or shooting mode selection of the remote camera is executed.

# Setting linking with a switcher

Configure the settings for linking the unit with an optional switcher. To use the function for linking with a switcher, you need to set the following in advance.

## ■ Settings for the connection between unit and switcher

Refer to “Settings for connecting with the remote cameras and switcher” in <Basics> (page 29).

## ■ Settings on the switcher

The following settings can be configured on the AW-HS50.

- **Enabling the function for linking with the unit**  
Set the “10. CamCont Link” item of [13] Operation Menu to “On”.
- **Displaying the remote camera names sent by the unit**  
Set the “4. Name Type” item of [10.1] SDI-IN1 to [10.4] SDI-IN4 or the “2. Name Type” item of [10.5] DVI-IN in [10] Input Menu to “CAM Name”.
- **Displaying icons at the bottom left of the sub screen for images of the remote camera selected on the unit when the switcher is outputting images of multi view**  
Set the “6. Input Status” item of [8] MultiView Out/Frame Menu to “On”.

For details, refer to the Operating Instructions for the switcher.

## ■ Registering the camera numbers that will correspond to the image inputs of the switcher

Refer to the relevant explanation in this section.

## ■ Enabling or disabling the function for linking with the switcher

Refer to the relevant explanation in this section.

## Registering the camera numbers that will correspond to the image inputs of the switcher

1. Press the MENU button.
2. Open SW INPUT menu [43].
3. Turn the F1 dial to display the input signal of the switcher to be set.

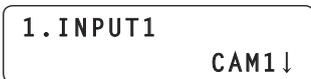

1. INPUT1  
CAM1 ↓

Input signal : Select from 1. INPUT1 to 100. INPUT100.

4. Turn the F2 dial to select the corresponding camera number, and then press the F2 dial to confirm the selection.

## Enabling or disabling the function for linking with the switcher

Enable or disable the entire function for linking between the unit and switcher.

1. Press the MENU button.
2. Open SW FUNCTION menu [42].
3. Turn the F1 dial to display the “1. SWLINK” item.



1. SWLINK  
On ↓

4. Turn the F2 dial to select “On” or “Off”, and then press the F2 dial to confirm the selection.

On : Enables the function for linking with the switcher.  
Off : Disables the function for linking with the switcher.

## Memo

- Enabling and disabling the link function can be assigned to a USER button.  
Open USER BUTTON menu [35], display one of the “1. USER1” to “8. USER8” items, and set “SWLINK”.
- When the USER button with “SWLINK” assigned is pressed, the operation is as follows.  
**Button indicator on** : Enables the function for linking with the switcher.  
**Button indicator off** : Disables the function for linking with the switcher.

## Note

- Up to one AW-RP120 or AW-RP50 can be linked to one switcher. Therefore, it is not possible to link the unit to a switcher that already has another AW-RP120 or an AW-RP50 linked. Disable the link function of the unit that is already linked and then enable the link function on this unit.

# Setting the functions for when the unit is linked with the switcher

Set the functions that can be used when there is a link between the unit and switcher.

Each of the functions needs to be set in advance in SW FUNCTION menu [42] and SW INPUT menu [43].

⇒ “Registering the camera numbers that will correspond to the image inputs of the switcher” (page 31)

⇒ “Enabling or disabling the function for linking with the switcher” (page 31)

## BUSCONT function

Select the bus material of the switcher from the unit.

When the BUSCONT function is enabled, the bus material of the switcher can be selected in conjunction with camera selection on the unit.

### Note

- When the link setting of a camera number is changed with AUTO IP menu [37], SWAP IP menu [38], or MANUAL IP menu [39] or a camera number corresponding to an image input of the switcher is changed with SW INPUT menu [43], the bus material of the switcher will not be changed immediately even if the BUSCONT function is enabled. Press one of the camera selection buttons [CAMERA SELECT/GROUP SELECT] to make a selection again.

## Enabling or disabling the BUSCONT function

1. Press the MENU button.

2. Open SW FUNCTION menu [42].

3. Turn the F1 dial to display the “2. BUSCONT” item.



4. Turn the F2 dial to select “On” or “Off”, and then press the F2 dial to confirm the selection.

**On** : Enables the BUSCONT function.

**Off** : Disables the BUSCONT function.

### Memo

- Enabling and disabling the BUSCONT function can be assigned to a USER button.

Open USER BUTTON menu [35], display one of the “1. USER1” to “8. USER8” items, and set “BUSCONT”.

- When the USER button with “BUSCONT” assigned is pressed, the operation is as follows.

**Button indicator on** : Enables the BUSCONT function.

**Button indicator off** : Disables the BUSCONT function.

## Setting the switcher bus to control with the BUSCONT function

When the BUSCONT function is enabled, you can set the switcher bus to control with a camera selection button [CAMERA SELECT/GROUP SELECT] on the unit.

1. Press the MENU button.

2. Open SW FUNCTION menu [42].

3. Turn the F1 dial to display the “3. BUS” item.



4. Turn the F2 dial to select a setting, and then press the F2 dial to confirm the setting.

**AUX** : The AUX bus of the switcher is the control target.

**PVW** : The PVW bus of the switcher is the control target.

**PinP** : The PinP bus of the switcher is the control target.

**KEY** : The KEY bus of the switcher is the control target.

### FOCUS ASSIST function

Control the AUX bus of the switcher and switch between the “images of multi view” and the “images of the selected remote camera”. Assigning this function to a USER button makes it optimal for adjusting the focus and other settings because you can fill the screen with the images of the selected remote camera with just the press of a button.

#### Setting the FOCUS ASSIST function

1. Press the MENU button.
2. Open SW FUNCTION menu [42].
3. Turn the F1 dial to display the “4. FOCUS ASSIST” item.

4. FOCUS ASSIST  
Off ↓

4. Turn the F2 dial to select “On” or “Off”, and then press the F2 dial to confirm the selection.

**On** : Switches the images of the AUX bus output from the switcher to the images of the remote camera selected with the unit.

**Off** : Switches the images of the AUX bus output from the switcher to the images of multi view.

#### Memo

- The FOCUS ASSIST function can be assigned to a USER button. Open **USER BUTTON** menu [35], display one of the “1. USER1” to “8. USER8” items, and set “FASSIST”.
- When the USER button with “FASSIST” assigned is pressed, the operation is as follows.
  - Button indicator on** : Switches the images of the AUX bus output from the switcher to the images of the remote camera selected with the unit.
  - Button indicator off** : Switches the images of the AUX bus output from the switcher to the images of multi view.

### CAMERA SELECT view function

Set the unit to display icons at the bottom left of the sub screen for images of the selected remote camera when the switcher is outputting images of multi view.

#### Enabling or disabling the CAMERA SELECT function

1. Press the MENU button.
2. Open SW FUNCTION menu [42].
3. Turn the F1 dial to display the “5. CAMERA SELECT” item.

5. CAMERA SELECT  
Off ↓

4. Turn the F2 dial to select “On” or “Off”, and then press the F2 dial to confirm the selection.

**On** : Enables the CAMERA SELECT view function.

**Off** : Disables the CAMERA SELECT view function.

## TALLY IP function

Enable TALLY IP to receive OA tally information from the switcher via the network.  
The lighting statuses of the camera status indicators on the unit and the tally lamps on the remote cameras are changed based on the received OA tally information.

### Enabling or disabling the TALLY IP function

1. Press the MENU button.
2. Open SW FUNCTION menu [42].
3. Turn the F1 dial to display the “6. TALLY\_IP” item.

6. TALLY\_IP  
Off ↓

4. Turn the F2 dial to select “On” or “Off”, and then press the F2 dial to confirm the selection.

**On** : Enables the TALLY IP function.  
**Off** : Disables the TALLY IP function.

- To enable tally lamp on instructions to be sent to a remote camera based on the tally information received from the switcher, you need to display the “4. TALLY OUT” item in CAMERA SETUP menu [24] and then set it to “On”.

#### Note

- The unit also sends the tally lamp on instruction to the corresponding remote camera when the unit receives tally information for a camera number belonging to a camera group that is not selected.

## Operating the switcher with the PAN/TILT lever and ZOOM button

You can use the unit's PAN/TILT lever and ZOOM button to change switcher settings (PinP position and size, etc.).

### Setting the application of the PAN/TILT lever and ZOOM button

1. Press the MENU button.
2. Open SW FUNCTION menu [42].
3. Turn the F1 dial to display the “7. P/T/Z CONTROL” item.

7. P/T/Z CONTROL  
CAM ↓

4. Turn the F2 dial to select a setting, and then press the F2 dial to confirm the selection.

#### CAM:

Allows you to operate the remote camera selected on the unit with the PAN/TILT lever and ZOOM button.

#### SW:

Allows you to change the switcher settings with the PAN/TILT lever and ZOOM button.

#### Button Select:

Allows you to select the operation target of the PAN/TILT lever and ZOOM button (remote cameras or switcher) by pressing the PAN/TILT ENABLE button or FOCUS/ZOOM/IRIS ENABLE button.

For each of the setting values above, the lighting state of the button indicator changes as follows when the PAN/TILT ENABLE button or FOCUS/ZOOM/IRIS ENABLE button is pressed.

#### <Change of lighting state when each ENABLE button is pressed>

| Setting value | Lighting state           |
|---------------|--------------------------|
| CAM           | On → Off<br>↑            |
| SW            | Blinking → Off<br>↑      |
| Button Select | On → Blinking → Off<br>↑ |

The following shows the operation with respect to the lighting state of each ENABLE button.

#### <PAN/TILT ENABLE button>

| Button indicator state | Operation when the PAN/TILT lever is operated  |
|------------------------|--|
| On                     | The remote camera is able to move horizontally and vertically.   |
| Blinking               | The operation is as follows depending on the state of the switcher. <ul style="list-style-type: none"> <li>● When Wipe Menu is open<br/>The transition start position (X, Y) can be moved horizontally and vertically.</li> <li>● When PinP Menu is open<br/>The PinP position (X, Y) can be moved horizontally and vertically.</li> <li>● When a chroma key marker is superimposed on the image output<br/>The chroma key marker position (X, Y) can be moved horizontally and vertically.</li> </ul> |
| Off                    | Operation is disabled.   |

#### <FOCUS/ZOOM/IRIS ENABLE button>

| Button indicator state | Operation when the ZOOM button is operated  |
|------------------------|---|
| On                     | The lens zoom of the remote camera can be changed.  |
| Blinking               | The operation is as follows depending on the state of the switcher. <ul style="list-style-type: none"> <li>● When PinP Menu is open<br/>The PinP size can be changed.</li> <li>● When a chroma key marker is superimposed on the image output<br/>The chroma key marker size can be changed.</li> </ul> |
| Off                    | Operation is disabled.  |

## CAM INF function

You can display the remote camera setting information acquired by the unit on the switcher AUX bus output images or multi view images.

- The setting information for the remote cameras included in the selected camera group is displayed.
- The setting information for a remote camera connected via a serial connection is displayed only when the camera is selected with a camera selection button [CAMERA SELECT/GROUP SELECT].

### Enabling or disabling the CAM INF function

1. Press the MENU button.
2. Open SW FUNCTION menu [42].
3. Turn the F1 dial to display the “8. CAM INF” item.



4. Turn the F2 dial to select “On” or “Off”, and then press the F2 dial to confirm the selection.
  - On : Enables the CAM INF view function.
  - Off : Disables the CAM INF view function.

#### Memo

- Enabling and disabling the CAM INF function can be assigned to a USER button. Open USER BUTTON menu [35], display one of the “1. USER1” to “8. USER8” items, and set “CAMINF”.
- When the USER button with “CAMINF” assigned is pressed, the operation is as follows.
  - Button indicator on : Enables the CAM INF function.
  - Button indicator off : Disables the CAM INF function.

### Selecting the remote camera setting information to superimpose on the images output from the switcher

1. Press the MENU button.
2. Open SW FUNCTION menu [42].

3. Turn the F1 dial to display any of the “9. CAMINF\_FORMAT” to “16. CAMINF\_ALARM” items.

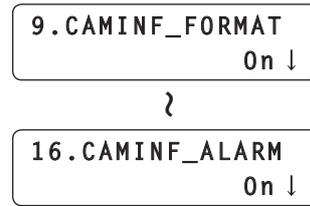

- 9. CAMINF\_FORMAT : ① Video format (This is left blank when the video format of the remote camera cannot be recognized.)
- 10. CAMINF\_CNAME : ② Remote camera name
- 11. CAMINF\_SCENE : ③ Shooting mode
- 12. CAMINF\_GAIN : ④ Gain value
- 13. CAMINF\_SHUTER : ⑤ Shutter information (ON/OFF, shutter value)
- 14. CAMINF\_IRIS : ⑥ Iris value
- 15. CAMINF\_FILTER : ⑦ Filter information
- 16. CAMINF\_ALARM : ⑧ Remote camera alarm information

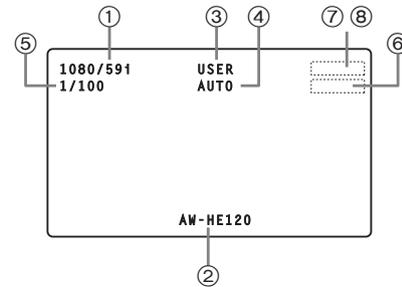

4. For each of the items, turn the F2 dial to select “On” or “Off”, and then press the F2 dial to confirm the selection.

- On : Enables display on the switcher.
- Off : Disables display on the switcher.

- CAMINF\_IRIS and CAMINF\_FILTER may not be displayed depending on the remote camera. (Refer to the following table.)

|                                    | CAMINF_IRIS | CAMINF_FILTER |
|------------------------------------|-------------|---------------|
| AW-HE120                           | —           | √             |
| AW-HE60, AW-HE50                   | —           | —             |
| AW-HE100                           | √           | —             |
| AW-HE870                           | √           | —             |
| AW-E860, AW-E750, AW-E650, AW-E350 | —           | —             |
| AK-HC1500, AK-HC1800               | √           | √             |

√: Displayed. —: Not displayed.

# Memory card operations

The unit allows you to use a memory card to perform the following operations.

**SAVE** : Save the configuration data of the unit or a remote camera to a memory card.

**LOAD** : Load the configuration data saved to a memory card to the unit or a remote camera.

## <Data Target for SAVE and LOAD>

| Data type | Description of data                                | File names *1          | SAVE/LOAD     |
|-----------|--|------------------------|---------------|
| RPDAT     | Configuration data of unit *2                      | RP01.s12 to RP99.s12   | SAVE and LOAD |
| CAM       | Configuration data stored on the remote cameras *3 | RP01.c12 to RP99.c12   | SAVE and LOAD |
| RPMEM     | Memory related data stored on the unit *4          | RP01.m12 to RP99.m12   | SAVE and LOAD |
| UPG       | Unit version update file                           | V****.r5d to V****.r5d | LOAD only     |
| LOG       | Unit operation log                                 | RP01.log to RP99.log   | SAVE only     |

\*1 : When SAVE is executed on the unit, the file names above are assigned automatically.

Also, after SAVE is executed on the unit, the file names can be changed with a personal computer.

- About file names  
RPDAT: \*\*\*\*\*.s12  
CAM: \*\*\*\*\*.c12  
RPMEM: \*\*\*\*\*.m12

Use "up to eight single-byte alphanumeric characters" for the \*\*\*\*\* part above. A file name other than the above may not be displayed properly on the unit.

\*2 : The IP address, subnet mask, default gateway settings of the unit and the user authentication settings (user name and password) are not target for the SAVE and LOAD operations.

\*3 : Only the following data for one selected remote camera is target for SAVE and LOAD.

- Settings of each shooting mode (scene file)
- Preset memory data
- System settings

\*4 : The following data is target for SAVE and LOAD.

- Tracing memory data  
All data of camera numbers CAM1 to CAM10
- PRESET SPEED  
PRESET SPEED values set for all preset numbers of camera numbers CAM1 to CAM100

## Notes

- SAVE and LOAD are not possible with the CAM item of a camera connected via a serial connection.
- Preset memory data is not included in "RPMEM".  
Therefore, when a different remote camera than the one when SAVE was executed is connected, just loading "RPMEM" to the unit will not result in the start position being recalled when the tracing memory is recalled.  
When replacing a remote camera, also execute SAVE and LOAD of "CAM".

## Precautions on handling memory cards

- Never remove a memory card while the memory card access lamp is lit or blinking.  
If you remove a memory card while the memory card access lamp is lit or blinking, the data saved to the memory card may be lost.
- The data stored in a memory card may be lost due to, for example, the loss or incorrect operation of the memory card.  
We recommend saving any important data to a computer or other device.

## Memory cards

Memory cards used with the unit should conform to SD or SDHC standards.

Be sure to use the unit to format memory cards.

Memory cards with the following capacity can be used with the unit.

SDXC memory cards and MultiMediaCards (MMC) are not supported.

|      |               |
|------|---------------|
| SD   | 8 MB to 2 GB  |
| SDHC | 4 GB to 32 GB |

For the latest information not described in the Operating Instructions, refer to the following websites.

<http://pro-av.panasonic.net/>

- Observe the following points when using and storing the memory cards.
  - Avoid high temperature and humidity.
  - Avoid water droplets.
  - Avoid static electricity.

## Initializing a memory card (INIT)

Before using a memory card with the unit, **be sure to initialize the memory card with the unit.**

When the memory card is initialized, the memory card is formatted (in compliance with SD standards) and dedicated directories are created.

### Note

- If you initialize a memory card, all of the files stored in the memory card will be deleted.  
Be sure to execute initialization after confirming the data because any data that is deleted by the initialization cannot be recovered.

1. Press the MENU button to turn on its indicator.

2. Open SD DELETE menu [48].

DEL MODE :RPDAT↓

3. Turn the F1 dial to display the "INIT" item, and then press the F1 dial to confirm the selection.

DEL MODE :INIT  
EXEC↓

4. Press the F2 dial.

Initialization of the memory card begins.

- When no memory card is inserted, "NO CARD!" appears.

INITIALIZING...  
NOT REMOVE CARD



COMPLETE

- When initialization completes, "COMPLETE" appears.
- When initialization fails, "INITIAL ERROR!" appears. Replace the memory card and then execute initialization again.

## Saving data to a memory card (SAVE)

1. Press one of the camera selection buttons [CAMERA SELECT/GROUP SELECT] to select a remote camera.

2. Press the MENU button to turn on its indicator.

3. Open SD SAVE menu [46].

SAVE MODE :RPDAT↓

4. Turn the F1 dial to select the type of data to save to the memory card, and then press the F1 dial to confirm the selection.

The file name assigned automatically in accordance with the selected data type is displayed on the second line of the LCD panel.

SAVE MODE :RPMEM  
RP10.m12↓

- You can select a data type from RPDAT, RPMEM, CAM, and LOG. However, when a remote camera connected via a serial connection is selected, CAM and RPMEM cannot be selected.
- The name of the file to be saved cannot be changed from the unit.
- When no memory card is inserted, "NO CARD!" appears.
- Up to 99 files of each of RPDAT, RPMEM, CAM, and LOG can be saved to one memory card. When 99 files already exist, "OVER 99FILES!" appears, and saving is not possible. Delete files and then execute saving again.  
⇒ "Deleting the files saved to a memory card (DELETE)" (page 38)

5. Press the F2 dial to confirm the selection.

Saving to the memory card begins.

SAVING...  
NOT REMOVE CARD



COMPLETE

- When saving completes, "COMPLETE" appears.
- When saving fails, "SAVE ERROR!" appears. Replace the memory card and then execute saving again.

### Loading data from a memory card (LOAD)

1. Press one of the camera selection buttons [CAMERA SELECT/GROUP SELECT] to select a remote camera.

2. Press the MENU button to turn on its indicator.

3. Open SD LOAD menu [47].

LOAD MODE : RPDAT ↓

4. Turn the F1 dial to select the type of data to load from the memory card, and then press the F1 dial to confirm the selection.

The file saved to the memory card is displayed on the second line of the LCD panel.

LOAD MODE : RPMEM  
RP10.m12 ↓

- You can select a data type from RPDAT, RPMEM, CAM, and UPG. However, when a remote camera connected via a serial connection is selected, CAM and RPMEM cannot be selected.
- When no memory card is inserted, "NO CARD!" appears.

5. Turn the F2 dial to select a file, and then press the F2 dial to confirm the selection.

The data begins to be read from the memory card and transferred to the unit or selected remote camera.

- When a file that cannot be loaded to the selected remote camera is specified (when, for example, you specify a file of a remote camera that is a different model), "LOAD ERROR!" appears.

LOADING...  
NOT REMOVE CARD



COMPLETE

- When loading completes, "COMPLETE" appears.
- When loading fails, "LOAD ERROR!" appears. Save the data to the memory card again and then execute loading again. If loading is still not possible, replace the memory card.

#### Note

- When "UPG" is selected as the data type and then LOAD is executed, the unit needs to be restarted after loading of the data completes. Turn the unit's power off and then back on.

### Deleting the files saved to a memory card (DELETE)

1. Press the MENU button to turn on its indicator.

2. Open SD DELETE menu [48].

DEL MODE : RPDAT ↓

3. Turn the F1 dial to select the type of data to delete, and then press the F1 dial to confirm the selection.

The name of the file saved to the memory card is displayed on the second line of the LCD panel.

DEL MODE : RPMEM  
RP10.m12 ↓

- You can select a data type from RPDAT, RPMEM, CAM, and LOG. For the operation when "INIT" is selected, refer to "Initializing a memory card (INIT)" (page 37).
- When no memory card is inserted, "NO CARD!" appears.

4. Turn the F2 dial to select a file to delete, and then press the F2 dial to confirm the selection.

The file is deleted.

COMPLETE

- When deleting completes, "COMPLETE" appears.
- When deleting fails, "DELETE ERROR!" appears. Save any necessary files to a computer and then initialize the memory card.

# Tally settings

The unit can receive the tally information of the switcher and other external devices from the TALLY/GPI connector (TALLY input) on the rear panel and two network lines.

To enable turning on the camera status indicators on the unit and the tally lamps on the remote cameras based on the received tally information, you need to configure the following settings.

## ■ Registering the camera numbers that will correspond to the TALLY inputs

Setting is required to use TALLY IN1 to TALLY IN10 signals from the TALLY/GPI connector (TALLY input) on the rear panel. Refer to the relevant explanation in this section.

## ■ Registering the camera numbers that will correspond to the image inputs of the switcher

Setting is required to use tally information received via the network. Refer to "Setting linking with a switcher" (page 31).

## ■ Setting the sending of tally information from the unit to remote cameras

Refer to the relevant explanation in this section.

## ■ Settings on remote cameras

Setting is required on the remote camera to enable turning on the tally lamp. Refer to the Operating Instructions for the corresponding model.

### Registering the camera numbers that will correspond to the TALLY inputs

1. Press the MENU button.
2. Open TALLY menu [44].
3. Turn the F1 dial to select the TALLY input connector number.



1. TALLY IN1  
CAM1 ↓

**Input connector number** : Select from TALLY IN1 to TALLY IN10.

4. Turn the F2 dial to select the corresponding camera number, and then press the F2 dial to confirm the selection.

**Camera number** : Select from CAM1 to CAM100.

### Setting the sending of tally information from the unit to remote cameras

1. Press the MENU button.
2. Open CAMERA SETUP menu [24].
3. Turn the F1 dial to display the "4. TALLY OUT" item.



4. TALLY OUT  
Off ↓

4. Turn the F2 dial to select "On" or "Off", and then press the F2 dial to confirm the selection.

**On** : Sends tally information to remote cameras.

**Off** : Does not send tally information to remote cameras.

#### Note

- When multiple remote camera controllers (this unit or AW-RP50) are connected to one remote camera, the tally information sent by each remote camera controller may not match and the tally lamp on the remote camera may not light correctly. In cases like this, set this setting to "On" on one of the remote camera controllers and "Off" on the other remote camera controllers.

# Checking alarm information

In the event of an error with the power supply of the unit or a remote camera included in the selected camera group, the ALARM indicator on the unit turns on and the output of the GPI OUT connector (GPI OUT 5) becomes On.

When an error occurs, you can check the alarm information by menu operation.

## Displaying alarm information

1. Press the MENU button.
2. Open ALARM menu [50].
3. Turn the F1 dial to display the item you want to check.  
The alarm status is displayed on the bottom line of the LCD panel.

1 . POWER  
No ALARM

### <Details of each alarm>

#### [Select 1. POWER]

Allows you to check the unit's power supply alarm.

##### No ALARM:

When the power supply is trouble-free.

##### ALARM:

When trouble has occurred with the power supply.

#### [Select 2. CAM### to 11. CAM###] (\*1)

Displays the alarm information for camera numbers included in the currently selected camera group.

##### No ALARM:

Trouble-free.

##### FAN ALM:

Trouble has occurred with the cooling fan.

##### P/T ALM:

Trouble has occurred with the pan/tilt operation.

##### FAN ALM+P/T ALM:

Trouble has occurred with the cooling fan and pan/tilt operation.

(\*1) CAM### is used to indicate a camera number included in the selected camera group. For example, when the F1 dial is turned while camera group "10" is selected, "2. CAM91" to "11. CAM100" are displayed on the top line of the LCD panel.

### Note

- When an alarm has occurred, stop operation immediately and be sure to contact your dealer.  
Continued use may cause the unit or a remote camera to malfunction.

## Returning the unit to the factory default state (INITIALIZE)

You can restore the settings stored on the unit to the factory defaults (INITIALIZE).

When executing INITIALIZE, select one of "ALL" or "SETUP".

- ALL** : Restores all settings to the factory default state (executes INITIALIZE).
- SETUP**: Restores only some settings to the factory default state (executes INITIALIZE).

### Note

- For details on initializing the settings stored on a remote camera, refer to the Operating Instructions for the remote camera.

Also, when you execute INITIALIZE, the data stored on the unit and the following statuses are restored to the factory default state.

### <Initialized data and statuses (ALL or SETUP)>

- Tracing memory data
- Movement speed when recalling preset memory (PRESET SPEED)
- Remote camera selection status
- Camera group selection status
- ENABLE button lighting statuses

### <Initialized data (ALL)>

- User authentication settings (user name and password)

### <Initialized setting items>

√: Target —: Not target

| Button number | Menu name       | Setting item                         | INITIALIZE    |                        |
|---------------|-----------------|--------------------------------------|---------------|------------------------|
|               |                 |                                      | ALL           | SETUP                  |
| [24]          | CAMERA SETUP    | 1. CAM POWER                         | √             | √                      |
|               |                 | 2. AUTO ON                           | √             | √                      |
|               |                 | 3. RECALL PST SPD                    | √             | √                      |
|               |                 | 4. TALLY OUT                         | √             | √                      |
| [25]          | RP SETUP        | 1. FOCUS/IRIS                        | √             | √                      |
|               |                 | 2. P/T CURV                          | √             | √                      |
|               |                 | 3. LCD BACKLIGHT                     | √             | √                      |
|               |                 | 4. ENABLE BUTTON                     | √             | √                      |
|               |                 | 5. MENU CONTROL                      | √             | √                      |
|               |                 | 6. GLOBAL AREA                       | √             | √                      |
|               |                 | 7. IP ADDRESS                        | √             | —                      |
|               |                 | 8. SUBNETMASK                        | √             | —                      |
|               |                 | 9. GATEWAY                           | √             | —                      |
|               |                 | 11. PORT CAM1 to 20. PORT CAM10      | √             | —                      |
|               |                 | [26]                                 | PAN DIRECTION | 1. CAM1 to 100. CAM100 |
| [27]          | TILT DIRECTION  | 1. CAM1 to 100. CAM100               | √             | √                      |
| [28]          | ZOOM DIRECTION  | 1. CAM1 to 100. CAM100               | √             | √                      |
| [29]          | FOCUS DIRECTION | 1. CAM1 to 100. CAM100               | √             | √                      |
| [31]          | PM GRP1         | 1. PM GRP1 MODE                      | √             | √                      |
|               |                 | 2. PM GRP1 1/10 to 11. PM GRP1 10/10 | √             | √                      |
|               |                 | 12. PM GRP1 ALL                      | √             | √                      |
| [32]          | PM GRP2         | 1. PM GRP2 MODE                      | √             | √                      |
|               |                 | 2. PM GRP2 1/10 to 11. PM GRP2 10/10 | √             | √                      |
|               |                 | 12. PM GRP2 ALL                      | √             | √                      |
| [33]          | PM GRP3         | 1. PM GRP3 MODE                      | √             | √                      |
|               |                 | 2. PM GRP3 1/10 to 11. PM GRP3 10/10 | √             | √                      |
|               |                 | 12. PM GRP3 ALL                      | √             | √                      |
| [34]          | PM GRP4         | 1. PM GRP4 MODE                      | √             | √                      |
|               |                 | 2. PM GRP4 1/10 to 11. PM GRP4 10/10 | √             | √                      |
|               |                 | 12. PM GRP4 ALL                      | √             | √                      |
| [35]          | USER BUTTON     | 1. USER1 to 8. USER8                 | √             | √                      |
| [36]          | CTRL TYPE       | 1. CAM1 to 100. CAM100               | √             | —                      |
| [38]          | SWAP IP         | 1. CAM1 to 100. CAM100               | √             | —                      |
| [39]          | MANUAL IP       | 1. CAM1 to 100. CAM100               | √             | —                      |
| [40]          | PORT NO         | 1. CAM1 to 100. CAM100               | √             | —                      |
| [41]          | SW SETUP        | 1. SW CTL                            | √             | —                      |
|               |                 | 2. SW IP ADDRESS                     | √             | —                      |
| [42]          | SW FUNCTION     | 1. SWLINK to 16. CAMINF_ALARM        | √             | √                      |
| [43]          | SW INPUT        | 1. INPUT1 to 100. INPUT100           | √             | —                      |
| [44]          | TALLY           | 1. TALLY IN1 to 10. TALLY IN10       | √             | √                      |
| [45]          | GPI OUT         | 1. CAM OUT1 to 10. CAM OUT10         | √             | √                      |

- For the factory default settings, refer to "Table of setting items (menus)" (pages 53 to 55).

## Returning the unit to the factory default state

1. Press the MENU button.
2. Open SYSTEM menu [49].
3. Turn the F1 dial to display the “1. INITIALIZE” item.

1. INITIALIZE  
ALL↓

4. Turn the F2 dial to select “ALL” or “SETUP”, and then press the F2 dial to confirm the selection.

INITIALIZE is executed.

**ALL** : Restores all settings to the factory default state (executes INITIALIZE).

**SETUP**: Restores only some settings to the factory default state (executes INITIALIZE).

### Note

- The unit needs to be rebooted after selecting “ALL” and then executing INITIALIZE. Turn the power off and then back on.

# Control interface for external devices

## ■ TALLY/GPI (JST: JBY-25S-1A3F(LF)(SN))

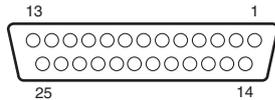

| Pin number | Signal name | Description of signal  | Operation  |
|------------|-------------|--|--|
| 1          | TALLY IN 1  | TALLY IN1 to TALLY IN10 tally inputs<br>⇒ "Tally settings" (page 39)   | Contact input<br>(Status operation)                                |
| 14         | TALLY IN 2  |  |  |
| 2          | TALLY IN 3  |  |  |
| 15         | TALLY IN 4  |  |  |
| 3          | TALLY IN 5  |  |  |
| 16         | TALLY IN 6  |  |  |
| 4          | TALLY IN 7  |  |  |
| 17         | TALLY IN 8  |  |  |
| 5          | TALLY IN 9  |  |  |
| 18         | TALLY IN 10 |  |  |
| 6          | GND         | GND  |  |
| 19         | GPI IN 1    | Calling of PMEM GROUP1 to PMEM GROUP4<br>⇒ "Recalling preset memory groups" (page 17)  | Contact input<br>(Trigger operation)<br>● Trigger width<br>≥ 30 ms |
| 7          | GPI IN 2    |  |  |
| 20         | GPI IN 3    |  |  |
| 8          | GPI IN 4    |  |  |
| 21         | GPI IN 5    | Control of the ENABLE BUTTON settings<br>⇒ "Enabling or disabling operation of the ENABLE buttons by menu operation" (page 28) |  |
| 9          | GPI IN 6    | Control of MENU CONTROL settings<br>⇒ "Enabling or disabling menu operation" (page 28)   |  |
| 22         | GND         | GND  |  |
| 10         | GPI OUT 1   | Remote camera selection 0 *  | Open collector output<br>(Status operation)                        |
| 23         | GPI OUT 2   | Remote camera selection 1 *  |  |
| 11         | GPI OUT 3   | Remote camera selection 2 *  |  |
| 24         | GPI OUT 4   | Remote camera selection 3 *  |  |
| 12         | GPI OUT 5   | Alarm  |  |
| 25         | GND         | GND  |  |
| 13         | NC          |  |  |

### Example of GPI OUT connection

Ensure that the conditions given below are satisfied.

Withstand voltage: Max. 24 V DC  
Current: Max. 50 mA

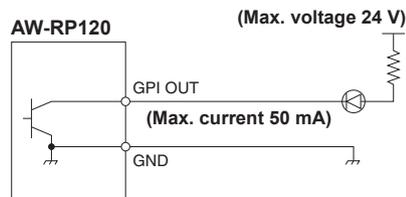

### Example of TALLY IN and GPI IN connections

Provide contact inputs.

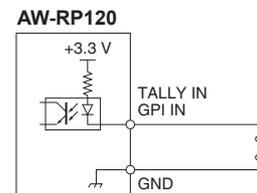

\*: For the cameras registered to the "1. CAM OUT1" to "10. CAM OUT10" items in GPI OUT menu [45], the selection states on the unit can be output to GPI OUT1 to GPI OUT4.

<Output states of GPI OUT1 to GPI OUT4 when the camera number registered to CAM OUT is selected>

|           | Output of GPI OUT1 to GPI OUT4 |          |          |          |
|-----------|--------------------------------|----------|----------|----------|
|           | GPI OUT1                       | GPI OUT2 | GPI OUT3 | GPI OUT4 |
| CAM OUT1  | On                             | Off      | Off      | Off      |
| CAM OUT2  | Off                            | On       | Off      | Off      |
| CAM OUT3  | On                             | On       | Off      | Off      |
| CAM OUT4  | Off                            | Off      | On       | Off      |
| CAM OUT5  | On                             | Off      | On       | Off      |
| CAM OUT6  | Off                            | On       | On       | Off      |
| CAM OUT7  | On                             | On       | On       | Off      |
| CAM OUT8  | Off                            | Off      | Off      | On       |
| CAM OUT9  | On                             | Off      | Off      | On       |
| CAM OUT10 | Off                            | On       | Off      | On       |

Registering camera numbers to CAM OUT1 to CAM OUT10

1. Press the MENU button.
2. Open GPI OUT menu [45].
3. Turn the F1 dial to display the “1. CAM OUT1” item.



4. Turn the F2 dial to select the camera number to set for CAM OUT1, and then press the F2 dial to confirm the selection.

Camera number : Select from CAM1 to CAM100.

5. Turn the F1 dial to display any of the “2. CAM OUT2” to “10. CAM OUT10” items and then register a camera number.

- Repeat steps 3 to 4.

■ REMOTE (JST: JEY-9P-1A3F(LF)(SN))

You can connect a personal computer or other external device to select the camera group, select the remote camera, and recall preset memory or tracing memory.

For further details, contact your dealer.

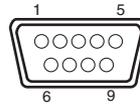

| Pin number | Signal name |
|------------|-------------|
| 1          | ---         |
| 2          | RXD IN      |
| 3          | TXD OUT     |
| 4          | DTR         |
| 5          | GND         |
| 6          | DSR         |
| 7          | RTS         |
| 8          | CTS         |
| 9          | ---         |

■ TO PAN/TILT HEAD 1 to 5 connectors (RJ-45)

Connect remote cameras with support for a serial connection to these connectors using LAN cables.

Connect them with straight cables (category 5 or better shielded cable).

| Pin number | Signal name | Description of signal         |
|------------|-------------|-------------------------------|
| 1          | GND         | Frame ground                  |
| 2          | TALLY       | Tally output (open collector) |
| 3          | TXD -       | Send data (-)                 |
| 4          | RXD -       | Receive data (-)              |
| 5          | RXD+        | Receive data (+)              |
| 6          | TXD+        | Send data (+)                 |
| 7          | NC          | Not used                      |
| 8          | NC          | Not used                      |

- TALLY (pin number: 2) specifications  
Voltage withstand: Max. 24 V DC  
Current: Max. 50 mA

■ LAN connector (RJ-45)

Connect a remote camera, switcher, or computer that supports an IP connection to this connector with a LAN cable.

When directly connecting a device to the unit, use a crossover cable (category 5 or better shielded cable).

When connecting via a hub (switching hub) or other device, use a straight cable (category 5 or better shielded cable).

# Setup Software

Setup Software is an application for configuring the settings for connecting the unit with the remote cameras and switcher from a personal computer. The settings can be configured while confirming each item in a list.

- The settings for connecting the unit with the remote cameras and switcher can also be configured using just the unit. For how to configure the settings on the unit, refer to “Settings for connecting with the remote cameras and switcher” in <Basics> (page 29).

## Notes

**When using Setup Software to configure the settings from a personal computer, observe the following.**

- Do not perform any operation on the unit.
- Do not start Setup Software on any other computer in the same network.
- Do not use “Easy IP Setup Software” supplied with AW-HE120, AW-HE60, and AW-HE50.

## Installing the software

This section describes how to install Setup Software.

1. Insert the CD-ROM supplied with the unit into the CD-ROM drive of the personal computer on which the application is going to be installed.
2. Copy the entire folder containing “Setup Software” on the CD-ROM to the hard disk drive of the personal computer.
3. Double-click “RP120Tool.exe” in the copied “Setup Software” folder to start Setup Software.

## Configuring the settings of the personal computer

Configure the following settings of the personal computer before connecting it to the unit.

- |                        |   |
|------------------------|---|
| <b>IP address</b>      | : Set an IP address that is not a duplicate of the IP address set on the unit or any IP address set on the devices (remote cameras, switcher, etc.) connected within the same subnet. |
| <b>Subnet mask</b>     | : Set the same subnet mask as that set on the unit.   |
| <b>Default gateway</b> | : Set the same default gateway as that set on the unit.   |

Confirm the IP address, subnet mask, and default gateway set on the unit in RP SETUP menu [25].

- |                        |                        |
|------------------------|------------------------|
| <b>IP address</b>      | : “7. IP ADDRESS” item |
| <b>Subnet mask</b>     | : “8. SUBNETMASK” item |
| <b>Default gateway</b> | : “9. GATEWAY” item    |

## Connecting the personal computer

Connect the personal computer and unit with a LAN cable.

- When directly connecting the personal computer to the unit, use a crossover cable (category 5 or better shielded cable).
- When connecting via a switching hub, use a straight cable (category 5 or better shielded cable).

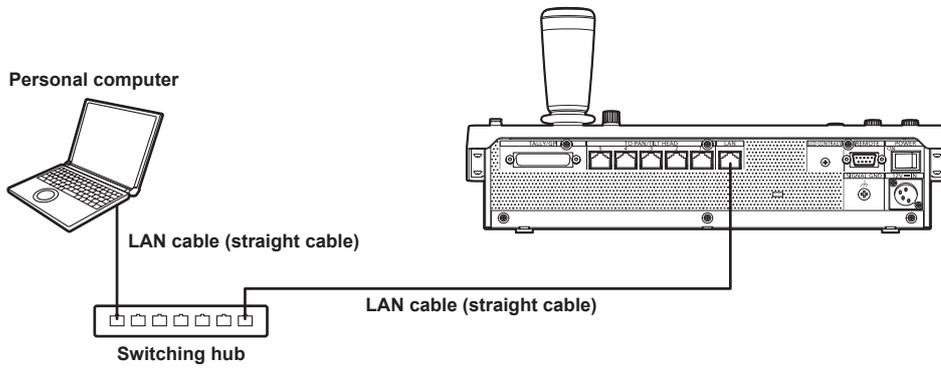
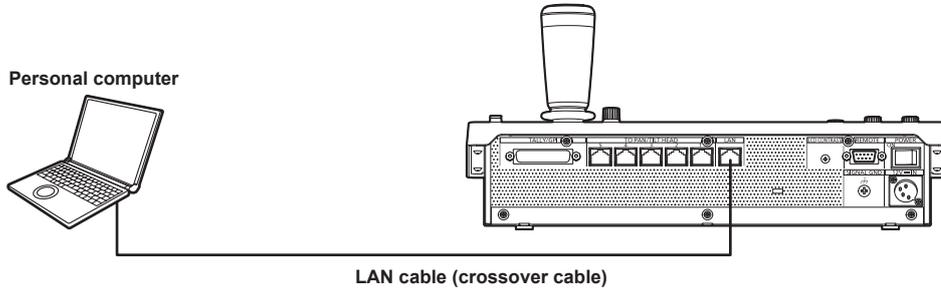

## Setup Software (continued)

The screens of Windows XP are used in the explanations in this manual.

If you are using an operating system other than Windows XP, some of the items displayed on the screens may differ.

### Registering the unit in Setup Software

On the "IP Address" tab, register the IP addresses of units to be set from Setup Software.

The units registered here can be selected from the list box on the "Setting" tab.

Up to five units can be registered.

Setting UserAuth. IP Address

AW-RP120 IP ADDRESS

RP1 192 . 168 . 0 . 9

RP2 192 . 168 . 0 . 8

RP3 192 . 168 . 0 . 7

RP4 192 . 168 . 0 . 6

RP5 192 . 168 . 0 . 5

Set

- 1. Enter the IP addresses in the IP ADDRESS boxes.**  
In the RP1 to RP5 boxes, enter the IP addresses of the AW-RP120 to register.
- 2. Click [Set] button.**
- 3. In the list box on the "Setting" tab, select the AW-RP120 whose data is to be referenced.**  
The settings configured on the selected unit are displayed on the "Setting" tab.

Setting UserAuth. IP Address

RP1(192.168.0.9)

| CAMERA / SW | CAMERA GROUP | CAMERA NO | CTRL TYPE |
|-------------|--------------|-----------|-----------|
|             |              | C001      | NoAssign  |
|             |              | C002      | NoAssign  |

## Settings for connecting with the remote cameras and switcher

## Displaying the “Setting” tab

On the “Setting” tab, configure the settings for the connections between the unit and the remote cameras and switcher. When you connect the personal computer to the unit for the first time, click the [REFRESH] button to acquire the values set on the unit. Each of the “C001” to “C100” and “SW” lines displays a list of the corresponding camera number and switcher connection setting information.

| 2          | 3            | 4         | 5         | 6           | 7        | 8                 | 9            | 10             | 11          |                 |       |
|------------|--------------|-----------|-----------|-------------|----------|-------------------|--------------|----------------|-------------|-----------------|-------|
| CAMERA /SW | CAMERA GROUP | CAMERA NO | CTRL TYPE | CAMERA NAME | SW INPUT | MAC ADDRESS       | IP ADDRESS   | CAMERA PORT NO | SWAP CAMERA | RECEIVE PORT NO | ALARM |
|            |              | C001      | Network   |             | INPUT1   | 00:00:00:00:00:00 | 192.168.0.10 | 80             |             | 61000           |       |
|            |              | C002      | Network   | AW-HE120    | INPUT2   | 00:00:00:00:00:00 | 192.168.0.11 | 80             |             | 61001           |       |
|            |              | C003      | Network   |             | INPUT3   | 00:00:00:00:00:00 | 192.168.0.12 | 80             |             | 61002           |       |

**1 Setting target selection list box**

Select the unit for which to configure the connection settings. Click  to display the IP addresses of the units that can be set from this software. Select the IP address of the unit you want to set from this list.

Any of the units registered in the “IP Address” tab can be selected.  
⇒ “Registering the unit in Setup Software” (page 47)

**2 CAMERA/SW**

Displays the types of devices to be connected.

**CAMERA** : Remote camera  
**SW** : Switcher

**3 CAMERA GROUP**

Displays the camera group numbers.

**4 CAMERA NO**

Displays the camera numbers.

**5 CTRL TYPE**

Select the connection types. Click  on the right and select a connection type from “Serial”, “Network”, or “NoAssign”.

**Serial** : Serial connection

**Network** : IP connection

**NoAssign** : No setting (default setting)

“Serial” can only be selected with GROUP1.

After making a change, click the [SET] button to reflect the change.

**Note**

- When “Serial” is selected and then the [SET] button is clicked while “6. GLOBAL AREA” of RP SETUP menu [25] is set to “On”, the display of the corresponding item will be “Serial” but the setting will not be reflected on the unit. Click the [REFRESH] button to acquire the values set on the unit and match the display values to those values.

**6 CAMERA NAME**

Displays the names of the cameras set on the remote cameras. They are displayed for the remote cameras in the currently selected group.

For remote cameras with a serial connection, a name is only displayed when a remote camera is selected on the unit.

**7 SW INPUT**

Set the image inputs of the switcher that correspond to the camera numbers on the unit.

Click  on the right and select an option from “NoAssign” and “INPUT1” to “INPUT100”.

After making a change, click the [SET] button to reflect the change.

**8 MAC ADDRESS**

Displays the MAC addresses of the remote cameras and switcher linked to the camera numbers on the unit.

- The camera numbers and switcher linked by auto IP setting are target for display.

**9 IP ADDRESS**

Set the IP addresses of the remote cameras and switcher that are connection destinations.

After input, click the [SET] button to reflect the changes.

**10 CAMERA PORT NO**

Set the port numbers of the remote cameras that are connection destinations.

After input, click the [SET] button to reflect the changes.

Possible setting range: 1 to 65535

However, the following values cannot be set even though they are within this range.

20, 21, 23, 25, 42, 53, 67, 68, 69, 110, 123, 161, 162, 995, 10669, 10670

**11 SWAP CAMERA**

Swap the remote cameras set as connection destinations between two camera numbers.

Click  to display camera numbers “C001” to “C100”.

Select the camera number with which you want to make the swap from this list.

After making a change, click the [SET] button to reflect the change.

Setting User Auth. IP Address

RP1(192.168.0.9)

| CAMERA /Sw | CAMERA GROUP | CAMERA NO | CTRL TYPE | CAMERA NAME | SW INPUT          | MAC ADDRESS       | IP ADDRESS   | CAMERA PORT NO | SWAP CAMERA | 12<br>RECEIVE PORT NO | 13<br>ALARM |
|------------|--------------|-----------|-----------|-------------|-------------------|-------------------|--------------|----------------|-------------|-----------------------|-------------|
| CAMERA     | 1            | C001      | Network   |             | INPUT1            | 00:00:00:00:00:00 | 192.168.0.10 | 80             |             | 61000                 |             |
|            |              | C002      | Network   | Aw-HE120    | INPUT2            | 00:00:00:00:00:00 | 192.168.0.11 | 80             |             | 61001                 |             |
|            |              | C003      | Network   |             | INPUT3            | 00:00:00:00:00:00 | 192.168.0.12 | 80             |             | 61002                 |             |
|            |              | C004      | Serial    |             | INPUT4            | 00:00:00:00:00:00 | 192.168.0.13 | 80             |             | 61003                 |             |
|            |              | C005      | Serial    | Aw-HE100    | INPUT5            | 00:00:00:00:00:00 | 192.168.0.14 | 80             |             | 61004                 |             |
|            |              | C006      | NoAssign  |             | NoAssign          | 00:00:00:00:00:00 | 192.168.0.15 | 80             |             | 61005                 |             |
|            |              | C007      | NoAssign  |             | NoAssign          | 00:00:00:00:00:00 | 192.168.0.16 | 80             |             | 61006                 |             |
|            |              | C008      | NoAssign  |             | NoAssign          | 00:00:00:00:00:00 | 192.168.0.17 | 80             |             | 61007                 |             |
|            |              | C009      | NoAssign  |             | NoAssign          | 00:00:00:00:00:00 | 192.168.0.18 | 80             |             | 61008                 |             |
|            |              | C010      | NoAssign  |             | NoAssign          | 00:00:00:00:00:00 | 192.168.0.19 | 80             |             | 61009                 |             |
|            | 2            | C011      | NoAssign  |             | NoAssign          | 00:00:00:00:00:00 | 192.168.0.20 | 80             |             | 61000                 |             |
|            |              | C012      | NoAssign  |             | NoAssign          | 00:00:00:00:00:00 | 192.168.0.21 | 80             |             | 61001                 |             |
|            |              | C013      | NoAssign  |             | NoAssign          | 00:00:00:00:00:00 | 192.168.0.22 | 80             |             | 61002                 |             |
|            |              | C014      | NoAssign  |             | NoAssign          | 00:00:00:00:00:00 | 192.168.0.23 | 80             |             | 61003                 |             |
|            |              | C015      | NoAssign  |             | NoAssign          | 00:00:00:00:00:00 | 192.168.0.24 | 80             |             | 61004                 |             |
| Sw         |              |           | Network   |             | 00:00:00:00:00:00 | 192.168.0.8       |              |                |             |                       |             |

14 RENEW    15 KEEP    16 REFRESH    17 ALL CLEAR    18 SET    19 CANCEL

**12 RECEIVE PORT NO**

Set the port numbers for the unit to receive camera information update notifications from remote cameras.  
Possible setting range: 61000 to 65535

- Set 10 port numbers because update notifications are received from the remote cameras included in the selected camera group. After entering the information on the “C001” to “C010” lines, click [SET] button to reflect the changes.

**13 ALARM**

Displays the alarm information of the remote cameras. It is displayed for the remote cameras belonging to the camera group selected on the unit.  
For remote cameras with a serial connection, the information is only displayed when a remote camera is selected on the unit.

**14 RENEW button**

Executes “RENEW IP ADR” in AUTO IP menu [37] of the unit. When you click [RENEW] button, the link setting targets (camera numbers and switcher) corresponding to the remote cameras and switcher newly detected by the unit are displayed in yellow. If you click [SET] button next, the settings are confirmed and the IP addresses of the remote cameras and switcher are updated. If you click [CANCEL] button, the settings are not reflected.

**15 KEEP button**

Executes “KEEP IP ADR” in AUTO IP menu [37] of the unit. When you click [KEEP] button, the link setting targets (camera numbers and switcher) corresponding to the remote cameras and switcher newly detected by the unit are displayed in yellow. If you click [SET] button next, the settings are confirmed and the connection destination IP addresses of the unit are updated. If you click [CANCEL] button, the settings are not reflected.

**16 REFRESH button**

Loads the connection information set on the unit to the personal computer and refreshes the display on the “Setting” tab.

**17 ALL CLEAR button**

Executes “ALL CLEAR” in AUTO IP menu [37] of the unit. When you click [ALL CLEAR] button, the connection types and the connection destination IP addresses set on the unit are initialized.

- When a connection type is set to “Network”, it is changed to “NoAssign”. When a connection type is set to “Serial”, it is not changed.

**18 SET button**

Confirms the changes on the “Setting” tab and updates the settings on the unit.

**19 CANCEL button**

Cancels the settings that were configured on the “Setting” tab.

## Setting user authentication

To control remote cameras that have the user authentication function enabled, you need to set the user name and password on the AW-RP120. Configure this setting on the “User Auth.” tab of this application.

- The user authentication function is only enabled when the unit is controlling remote cameras connected with IP connections. Also refer to the Operating Instructions for the remote cameras.

The screenshot shows the 'User Auth.' configuration page. It features five input fields for user authentication settings: 'Old User Name', 'New User Name:', 'Old Password', 'New Password:', and 'Retype New Password:'. Below these fields are two buttons: 'REFRESH' and 'SET'. A box highlights the input fields, and an arrow points from a text box below to the 'REFRESH' button.

**1. Click the [REFRESH] button.**

The user name set on the unit is displayed in the “Old User Name” box.

- “admin” is set by default.

**2. In the “New User Name” box, enter the new user name to set.**

**3. In the “Old Password” box, enter the password set on the unit.**

Entered characters are displayed as “\*”.

- “12345” is set by default.

**4. In the “New Password” box, enter the new password to set.**

Entered characters are displayed as “\*”.

**5. In the “Retype New Password” box, enter the same password as you entered in step 4.**

Entered characters are displayed as “\*”.

**6. Click the [SET] button.**

The user name and password are set on the unit.

When remote cameras with the user authentication function enabled are controlled, the user name and password that were set here are used.

---

**Memo**

- Even if you have forgotten the new password you set by performing the procedure above, you can still configure the settings again by entering “admin” in the “Old User Name” box and “12345” in the “Old Password” box and then entering a new user name and password in the other boxes.
-

# Operations of AW-HE2

AW-HE2 HD integrated cameras can be operated from the unit. This section describes the operations which are different from the corresponding operations of other remote cameras.

## Note

- The method for connecting AW-HE2 and the unit is the same as that for connecting AW-HE2 and AW-RP50. Refer to the Operating Instructions for the AW-HE2.

## <Invalid operations>

|                                     |   |
|-------------------------------------|---|
| <b>Color adjustment section</b>     | R/B GAIN dial, R/B PED dial, PED dial, GAIN button, DETAIL button, AUTO GAIN button, ABB button |
| <b>Focus, zoom and iris section</b> | FOCUS dial, Auto focus button, One-touch auto focus button, FOCUS SPEED dial                    |
| <b>User button section</b>          | SCENE 1 to SCENE 4 buttons (*)  |

- (\*) Even if you press these buttons while the SHIFT button indicator is on, the operations will have no effect.  
(The shooting mode cannot be selected.)

## <Indications which are different>

|   |  |
|---|--|
| <b>IRIS indicator</b>                           | Display is not updated during auto iris use. |
| <b>ZOOM indicator</b><br><b>FOCUS indicator</b> | All indicators are off.                      |

## <Operations which are different>

|                       |   |
|-----------------------|---|
| <b>PAN/TILT lever</b> | When the zoom position is the WIDE end side, the output images do not change even if the lever is operated.   |
| <b>Preset memory</b>  | <ul style="list-style-type: none"> <li>● The preset numbers that can be registered and recalled are PMEM 1 to PMEM 9 (page number: Page 1).</li> <li>● PRESET SCOPE and PRESET SPEED cannot be set.</li> </ul>  |
| <b>Tracing memory</b> | The start position cannot be stored in TMEM10.  |
| <b>SD card</b>        | SAVE and LOAD of the CAM item cannot be executed.   |
| <b>USER buttons</b>   | <p>If the following settings are assigned, PinP display of AW-HE2 can be operated with the USER buttons.</p> <p><b>CAM_PINP DISP:</b><br/>Displays or hides PinP.<br/>Each press of the button switches in the order of display PinP → hide PinP → display PinP, and so on.</p> <p><b>CAM_PINP CTL:</b><br/>Switches the control target (control mode) of the PAN/TILT lever and ZOOM button.<br/>Each press of the button switches in the order of PinP → main screen → PinP, and so on.</p> <p><b>CAM_PINP POS:</b><br/>Changes the display position of PinP.<br/>Each press of the button switches in the order of top right → bottom right → bottom left → top left → top right, and so on.</p> |

- For the PinP display function of AW-HE2, refer to the Operating Instructions for the AW-HE2.

## <Invalid menu operations>

| Menu            | Setting item    |
|-----------------|-----------------|
| SHUTTER [21]    | 1. SHUTTER      |
|                 | 2. SPEED        |
| ND FILTER [22]  | 1. ND FILTER    |
| PTZ ADJUST [30] | 2. SPEED WITH Z |
|                 | 3. LIMIT UP     |
|                 | 4. LIMIT DOWN   |
|                 | 5. LIMIT LEFT   |
|                 | 6. LIMIT RIGHT  |

## Table of setting items (dedicated dials and buttons)

| Dial/button   | Setting item     | Remote camera                      | Setting <sup>(*1)</sup>                           |
|---------------|------------------|------------------------------------|---|
| R/B GAIN dial | R GAIN<br>B GAIN | AW-HE120                           | -150 to +150                                      |
|               |                  | AW-HE50 <sup>(*2)</sup> , AW-HE60  | -30 to +30  |
|               |                  | AW-HE2                             | "---"   |
|               |                  | AW-HE100                           | -30 to +30  |
|               |                  | AW-HE870                           | -150 to +150                                      |
|               |                  | AW-E860, AW-E750, AW-E650, AW-E350 | -150 to +150                                      |
|               |                  | AK-HC1500, AK-HC1800               | -150 to +150                                      |
| R/B PED dial  | R PED<br>B PED   | AW-HE120                           | -150 to +150                                      |
|               |                  | AW-HE50, AW-HE60                   | "---"   |
|               |                  | AW-HE2                             | "---"   |
|               |                  | AW-HE100                           | "---"   |
|               |                  | AW-HE870                           | -150 to +150                                      |
|               |                  | AW-E860, AW-E750, AW-E650, AW-E350 | -150 to +150                                      |
|               |                  | AK-HC1500, AK-HC1800               | -100 to +100                                      |
| PED dial      | PED              | AW-HE120                           | -150 to +150                                      |
|               |                  | AW-HE50, AW-HE60                   | -10 to +10  |
|               |                  | AW-HE2                             | "---"   |
|               |                  | AW-HE100                           | -30 to +30  |
|               |                  | AW-HE870                           | -150 to +150                                      |
|               |                  | AW-E860, AW-E750, AW-E650, AW-E350 | -150 to +150                                      |
|               |                  | AK-HC1500, AK-HC1800               | -150 to +150                                      |
| GAIN button   | GAIN             | AW-HE120                           | Auto, 0 dB to 18 dB (1 step)                      |
|               |                  | AW-HE50, AW-HE60                   | Auto, 0 dB, 3 dB, 6 dB, 9 dB, 12 dB, 15 dB, 18 dB |
|               |                  | AW-HE2                             | "---"   |
|               |                  | AW-HE100                           | Auto, 0 dB to 12 dB (1 step), 15 dB, 18 dB        |
|               |                  | AW-HE870                           | Auto, -6 dB to 18 dB (1 step)                     |
|               |                  | AW-E860, AW-E750, AW-E650          | Auto, 0 dB to 30 dB, N/Eye L, N/Eye, N/Eye H      |
|               |                  | AW-E350                            | Auto, 0 dB to 30 dB, N/Eye                        |
|               |                  | AK-HC1500, AK-HC1800               | LOW, MID, HIGH, S.GAIN1, S.GAIN2, S.GAIN3         |
| DETAIL button | DETAIL           | AW-HE2                             | "---"   |
|               |                  | Other than AW-HE2                  | Off, On   |
|               | LEVEL            | AW-HE120                           | Low, High   |
|               |                  | AW-HE50, AW-HE60                   | Low, High   |
|               |                  | AW-HE2                             | "---"   |
|               |                  | AW-HE100                           | 0 to 14   |
|               |                  | AW-HE870                           | Low, High   |
|               |                  | AW-E860, AW-E750, AW-E650, AW-E350 | Low, High   |
|               |                  | AK-HC1500, AK-HC1800               | "---"   |

(\*1) "---" indicates a setting that cannot be changed.

(\*2) AW-HE50 without the AW-HEF5HG/AW-HEF5SG upgrade kit installed cannot operate R GAIN and B GAIN.

| Dial/button        | Setting item | Remote camera                                    | Setting <sup>(*1)</sup> |
|--------------------|--------------|--|-------------------------|
| MEM SETTING button | SPEED        | AW-HE120, AW-HE50, AW-HE60                       | 1 to 30 <sup>(*3)</sup> |
|                    |              | AW-HE2   | "---"                   |
|                    |              | AW-HE100, AW-PH360, AW-PH400, AW-PH405, AW-PH650 | 1 to 30 <sup>(*3)</sup> |
|                    | SCOPE        | AW-HE120, AW-HE50, AW-HE60                       | MODE A, MODE B, MODE C  |
|                    |              | AW-HE2   | "---"                   |
|                    |              | AW-HE100, AW-PH360, AW-PH400, AW-PH405, AW-PH650 | "---"                   |

(\*3) This is indicated as "---" in TMEM mode and cannot be set.

## Table of setting items (menus)

| Button number | Menu name       | Setting item                         | Remote camera                      | Initial value on unit (*1) | Setting (*2)  |
|---------------|-----------------|--------------------------------------|------------------------------------|----------------------------|---|
| [21]          | SHUTTER         | 1. SHUTTER                           | AW-HE120                           | –                          | Off, Step, Synchro, ELC   |
|               |                 |                                      | AW-HE50, AW-HE60                   | –                          | Off, Step, Synchro  |
|               |                 |                                      | AW-HE2                             | –                          | “---”   |
|               |                 |                                      | AW-HE100                           | –                          | Off, Step, Synchro  |
|               |                 |                                      | AW-HE870                           | –                          | Off, Step, Synchro, ELC   |
|               |                 |                                      | AW-E860, AW-E750, AW-E650, AW-E350 | –                          | Off, Step, Synchro, ELC   |
|               |                 |                                      | AK-HC1500, AK-HC1800               | –                          | Off, Step, Synchro  |
|               |                 | 2. SPEED                             | AW-HE120                           | –                          | <b>59.94 Hz:</b><br>1/100, 1/250, 1/500, 1/1000, 1/2000, 1/4000, 1/10000<br><b>50 Hz:</b><br>1/120, 1/250, 1/500, 1/1000, 1/2000, 1/4000, 1/10000 |
|               |                 |                                      | AW-HE50, AW-HE60                   | –                          | 1/100, 1/250, 1/500, 1/1000, 1/2000, 1/4000, 1/10000  |
|               |                 |                                      | AW-HE2                             | –                          | “---”   |
|               |                 |                                      | AW-HE100                           | –                          | 1/100, 1/250, 1/500, 1/1000, 1/2000   |
|               |                 |                                      | AW-HE870                           | –                          | 1/100, 1/250, 1/500, 1/1000, 1/2000, 1/4000, 1/10000  |
|               |                 |                                      | AW-E860, AW-E750, AW-E650, AW-E350 | –                          | 1/100, 1/250, 1/500, 1/1000, 1/2000, 1/4000, 1/10000  |
|               |                 |                                      | AK-HC1500, AK-HC1800               | –                          | <b>VIDEO:</b><br>1/100, 1/120, 1/250, 1/500, 1/1000, 1/2000<br><b>FILM:</b><br>180.0, 172.8, 144.0, 120.0, 90.0, 45.0                             |
| [22]          | ND FILTER       | 1. ND FILTER                         | –                                  | ND1, ND2, ND3, ND4         |   |
| [23]          | FUNCTION        | 1. OPTION                            | –                                  | Off, On                    |   |
|               |                 | 2. DEFROSTER                         | –                                  | Off, On                    |   |
|               |                 | 3. WIPER                             | –                                  | Off, On                    |   |
|               |                 | 4. HEATER/FAN                        | –                                  | Off, On                    |   |
|               |                 | 5. LAMP                              | –                                  | Off, On                    |   |
| [24]          | CAMERA SETUP    | 1. CAM POWER                         |                                    | GROUP ON                   | GROUP OFF, GROUP ON, ALL OFF, ALL ON  |
|               |                 | 2. AUTO ON                           |                                    | On                         | On, Off   |
|               |                 | 3. RECALL PST SPD                    |                                    | Off                        | Off, Off  |
|               |                 | 4. TALLY OUT                         |                                    | Off                        | On, Off   |
|               |                 | 5. HOME POSITION                     |                                    | SET                        | SET   |
| [25]          | RP SETUP        | 1. FOCUS/IRIS                        |                                    | STANDARD                   | STANDARD, EXCHANGE  |
|               |                 | 2. P/T CURV                          |                                    | 1                          | 1 to 5  |
|               |                 | 3. LCD BACKLIGHT                     |                                    | On                         | On, Off, 60, 120, 180   |
|               |                 | 4. ENABLE BUTTON                     |                                    | ACTIVE                     | ACTIVE, LOCK  |
|               |                 | 5. MENU CONTROL                      |                                    | ACTIVE                     | ACTIVE, LOCK  |
|               |                 | 6. GLOBAL AREA                       |                                    | Off                        | On, Off   |
|               |                 | 7. IP ADDRESS                        |                                    | 192.168.0.9                |   |
|               |                 | 8. SUBNETMASK                        |                                    | 255.255.255.0              |   |
|               |                 | 9. GATEWAY                           |                                    | 192.168.0.1                |   |
|               |                 | 10. MAC ADDRESS                      |                                    |                            | Displayed only  |
|               |                 | 11. PORT CAM1<br>⋮<br>20. PORT CAM10 |                                    | 61000<br>⋮<br>61009        | 61000 to 65535<br>⋮<br>61000 to 65535   |
| [26]          | PAN DIRECTION   | 1. CAM1<br>⋮<br>100. CAM100          |                                    | NORMAL<br>⋮<br>NORMAL      | NORMAL, REVERSE<br>⋮<br>NORMAL, REVERSE   |
|               |                 | 1. CAM1<br>⋮<br>100. CAM100          |                                    | NORMAL<br>⋮<br>NORMAL      | NORMAL, REVERSE<br>⋮<br>NORMAL, REVERSE   |
| [27]          | TILT DIRECTION  | 1. CAM1<br>⋮<br>100. CAM100          |                                    | NORMAL<br>⋮<br>NORMAL      | NORMAL, REVERSE<br>⋮<br>NORMAL, REVERSE   |
|               |                 | 1. CAM1<br>⋮<br>100. CAM100          |                                    | NORMAL<br>⋮<br>NORMAL      | NORMAL, REVERSE<br>⋮<br>NORMAL, REVERSE   |
| [28]          | ZOOM DIRECTION  | 1. CAM1<br>⋮<br>100. CAM100          |                                    | NORMAL<br>⋮<br>NORMAL      | NORMAL, REVERSE<br>⋮<br>NORMAL, REVERSE   |
|               |                 | 1. CAM1<br>⋮<br>100. CAM100          |                                    | NORMAL<br>⋮<br>NORMAL      | NORMAL, REVERSE<br>⋮<br>NORMAL, REVERSE   |
| [29]          | FOCUS DIRECTION | 1. CAM1<br>⋮<br>100. CAM100          |                                    | NORMAL<br>⋮<br>NORMAL      | NORMAL, REVERSE<br>⋮<br>NORMAL, REVERSE   |
|               |                 | 1. CAM1<br>⋮<br>100. CAM100          |                                    | NORMAL<br>⋮<br>NORMAL      | NORMAL, REVERSE<br>⋮<br>NORMAL, REVERSE   |

(\*1) “–” indicates a setting saved to the remote camera.

A diagonal line indicates a setting that can only be displayed. It cannot be changed.

(\*2) “---” indicates a setting that cannot be changed.

Table of setting items (menus) (continued)

| Button number     | Menu name   | Setting item      | Remote camera                          | Initial value on unit (*1) | Setting (*2)   |              |   |
|-------------------|-------------|-------------------|--|----------------------------|--|--------------|---|
| [30]              | PTZ ADJUST  | 1. Z MIN SPEED    |  | Off                        | Off, 1 to 8  |              |   |
|                   |             | 2. SPEED WITH Z   | AW-HE120                               | —                          | Off, On  |              |   |
|                   |             |                   | AW-HE50, AW-HE60                       | —                          | Off, On  |              |   |
|                   |             |                   | AW-HE2                                 | —                          | “—”  |              |   |
|                   |             |                   | AW-HE100                               | —                          | Off, 1, 2  |              |   |
|                   |             | 3. LIMIT UP       | AW-PH360, AW-PH400, AW-PH405, AW-PH650 | —                          | Off, 1, 2  |              |   |
|                   |             |                   | AW-HE120                               | —                          | Off, On  |              |   |
|                   |             |                   | AW-HE50, AW-HE60                       | —                          | Off, On  |              |   |
|                   |             |                   | AW-HE2                                 | —                          | “—”  |              |   |
|                   |             | 4. LIMIT DOWN     | AW-HE100                               | —                          | EXEC   |              |   |
|                   |             |                   | AW-PH360, AW-PH400, AW-PH405, AW-PH650 | —                          | EXEC   |              |   |
|                   |             |                   | AW-HE120                               | —                          | Off, On  |              |   |
|                   |             |                   | AW-HE50, AW-HE60                       | —                          | Off, On  |              |   |
|                   |             | 5. LIMIT LEFT     | AW-HE2                                 | —                          | “—”  |              |   |
|                   |             |                   | AW-HE100                               | —                          | EXEC   |              |   |
|                   |             |                   | AW-PH360, AW-PH400, AW-PH405, AW-PH650 | —                          | EXEC   |              |   |
|                   |             |                   | AW-HE120                               | —                          | Off, On  |              |   |
|                   |             | 6. LIMIT RIGHT    | AW-HE50, AW-HE60                       | —                          | Off, On  |              |   |
|                   |             |                   | AW-HE2                                 | —                          | “—”  |              |   |
|                   |             |                   | AW-HE100                               | —                          | EXEC   |              |   |
|                   |             |                   | AW-PH360, AW-PH400, AW-PH405, AW-PH650 | —                          | EXEC   |              |   |
|                   |             | [31]              | PM GRP1                                | 1. PM GRP1 MODE            |  | Off          | Off, SEPARATE, ALL                              |
|                   |             |                   |  | 2. PM GRP1 1/10            |  | NoAsgn ----- | NoAsgn -----,<br>CAM001 PRE001 to CAM100 PRE100 |
|                   |             |                   |  | 3. PM GRP1 2/10            |  | NoAsgn ----- |   |
| ⋮                 |             |                   |  | ⋮                          |  |              |   |
| 11. PM GRP1 10/10 |             |                   |  | NoAsgn -----               |  |              |   |
| 12. PM GRP1 ALL   |             |                   |  | NoAsgn                     | NoAsgn, PRE001 to PRE100   |              |   |
| [32]              | PM GRP2     | 1. PM GRP2 MODE   |  | Off                        | Off, SEPARATE, ALL   |              |   |
|                   |             | 2. PM GRP2 1/10   |  | NoAsgn -----               | NoAsgn -----,<br>CAM001 PRE001 to CAM100 PRE100  |              |   |
|                   |             | 3. PM GRP2 2/10   |  | NoAsgn -----               |  |              |   |
|                   |             | ⋮                 |  | ⋮                          |  |              |   |
|                   |             | 11. PM GRP2 10/10 |  | NoAsgn -----               |  |              |   |
|                   |             | 12. PM GRP2 ALL   |  | NoAsgn                     | NoAsgn, PRE001 to PRE100   |              |   |
| [33]              | PM GRP3     | 1. PM GRP3 MODE   |  | Off                        | Off, SEPARATE, ALL   |              |   |
|                   |             | 2. PM GRP3 1/10   |  | NoAsgn -----               | NoAsgn -----,<br>CAM001 PRE001 to CAM100 PRE100  |              |   |
|                   |             | 3. PM GRP3 2/10   |  | NoAsgn -----               |  |              |   |
|                   |             | ⋮                 |  | ⋮                          |  |              |   |
|                   |             | 11. PM GRP3 10/10 |  | NoAsgn -----               |  |              |   |
|                   |             | 12. PM GRP3 ALL   |  | NoAsgn                     | NoAsgn, PRE001 to PRE100   |              |   |
| [34]              | PM GRP4     | 1. PM GRP4 MODE   |  | Off                        | Off, SEPARATE, ALL   |              |   |
|                   |             | 2. PM GRP4 1/10   |  | NoAsgn -----               | NoAsgn -----,<br>CAM001 PRE001 to CAM100 PRE100  |              |   |
|                   |             | 3. PM GRP4 2/10   |  | NoAsgn -----               |  |              |   |
|                   |             | ⋮                 |  | ⋮                          |  |              |   |
|                   |             | 11. PM GRP4 10/10 |  | NoAsgn -----               |  |              |   |
|                   |             | 12. PM GRP4 ALL   |  | NoAsgn                     | NoAsgn, PRE001 to PRE100   |              |   |
| [35]              | USER BUTTON | 1. USER1          |  | ND1                        | ND1 to 4, SWLINK, BUSCONT,<br>FASSIST, CAMSEL, CAMINF,<br>TALLY_IP, POWER OFF,<br>CAM_PINP DISP, CAM_PINP CTL,<br>CAM_PINP POS |              |   |
|                   |             | 2. USER2          |  | ND2                        |  |              |   |
|                   |             | 3. USER3          |  | ND3                        |  |              |   |
|                   |             | 4. USER4          |  | ND4                        |  |              |   |
|                   |             | 5. USER5          |  | SWLINK                     |  |              |   |
|                   |             | 6. USER6          |  | BUSCONT                    |  |              |   |
|                   |             | 7. USER7          |  | FASSIST                    |  |              |   |
|                   |             | 8. USER8          |  | CAMSEL                     |  |              |   |
| [36]              | CTRL TYPE   | 1. CAM1           |  | NoAsgn                     | Serial, Network, NoAsgn  |              |   |
|                   |             | ⋮                 |  | ⋮                          |  |              |   |
|                   |             | 100. CAM100       |  | NoAsgn                     |  |              |   |
| [37]              | AUTO IP     | 1. AUTO SET       |  | RENEW IP ADR               | RENEW IP ADR, KEEP IP ADR,<br>ALL CLEAR  |              |   |

(\*1) “—” indicates a setting saved to the remote camera.

(\*2) “----” indicates a setting that cannot be changed.

Table of setting items (menus) (continued)

| Button number | Menu name   | Setting item  | Remote camera | Initial value on unit (*1)   | Setting  |
|---------------|-------------|---|---------------|--|--|
| [38]          | SWAP IP     | 1. CAM1<br>⋮<br>100. CAM100   |               | -----<br>⋮<br>-----  |  |
| [39]          | MANUAL IP   | 1. CAM1<br>⋮<br>100. CAM100   |               | 192.168.0.10<br>⋮<br>192.168.0.109   |  |
| [40]          | PORT NO     | 1. CAM1<br>⋮<br>100. CAM100   |               | 80<br>⋮<br>80  | 1 to 65535<br>⋮<br>1 to 65535  |
| [41]          | SW SETUP    | 1. SW CTL<br>2. SW IP ADDRESS   |               | NoAssign<br>192.168.000.008  | Network, NoAssign  |
| [42]          | SW FUNCTION | 1. SWLINK<br>2. BUSCONT<br>3. BUS<br>4. FOCUS ASSIST<br>5. CAMERA SELECT<br>6. TALLY_IP<br>7. P/T/Z CONTROL<br>8. CAM INF<br>9. CAMINF_FORMAT<br>10. CAMINF_CNAME<br>11. CAMINF_SCENE<br>12. CAMINF_GAIN<br>13. CAMINF_SHUTER<br>14. CAMINF_IRIS<br>15. CAMINF_FILTER<br>16. CAMINF_ALARM |               | On<br>Off<br>AUX<br>Off<br>Off<br>Off<br>CAM<br>On<br>On<br>On<br>On<br>On<br>On<br>On<br>On<br>On<br>On | Off, On<br>Off, On<br>AUX, PVW, PinP, KEY<br>Off, On<br>Off, On<br>Off, On<br>CAM, SW, Button Select<br>Off, On<br>Off, On<br>Off, On<br>Off, On<br>Off, On<br>Off, On<br>Off, On<br>Off, On |
| [43]          | SW INPUT    | 1. INPUT1<br>2. INPUT2<br>3. INPUT3<br>4. INPUT4<br>5. INPUT5<br>6. INPUT6<br>⋮<br>100. INPUT100  |               | CAM1<br>CAM2<br>CAM3<br>CAM4<br>CAM5<br>NoAssign<br>⋮<br>NoAssign  | NoAssign, CAM1 to CAM100   |
| [44]          | TALLY       | 1. TALLY IN1<br>⋮<br>10. TALLY IN10   |               | CAM1<br>⋮<br>CAM10   | CAM1 to CAM100   |
| [45]          | GPI OUT     | 1. CAM OUT1<br>⋮<br>10. CAM OUT10   |               | CAM1<br>⋮<br>CAM10   | CAM1 to CAM100   |
| [46]          | SD SAVE     | SAVE MODE   |               | RPDAT  | RPDAT, CAM, RPMEM, LOG (*2)  |
| [47]          | SD LOAD     | LOAD MODE   |               | RPDAT  | RPDAT, CAM, RPMEM, UPG (*2)  |
| [48]          | SD DELETE   | DEL MODE  |               | RPDAT  | RPDAT, CAM, RPMEM, LOG, INIT   |
| [49]          | SYSTEM      | 1. INITIALIZE<br>2. SYSTEM VER<br>3. PROGRAM VER<br>4. FPGA VER   |               | ALL<br>/-----<br>/-----<br>/-----  | ALL, SETUP<br>V*.*.* (displayed only)<br>V*.*.* (displayed only)<br>V*.*.* (displayed only)  |
| [50]          | ALARM       | 1. POWER<br>2. CAM###<br>⋮<br>11. CAM### (*3)   |               | /-----<br>/-----<br>/-----   | ALARM, No ALARM (displayed only)<br>FAN ALM, P/T ALM,<br>FAN ALM+P/T ALM,<br>No ALARM (displayed only)   |

(\*1) “-” indicates a setting saved to the remote camera.

A diagonal line indicates a setting that can only be displayed. It cannot be changed.

(\*2) When a camera number with Serial or NoAssign set in CTRL TYPE menu [36] is selected, “CAM” and “RPMEM” are not displayed.

(\*3) CAM### indicates a camera number included in the selected camera group.

# Messages

## When starting up and switching camera groups

| Indication                | Description   |
|---------------------------|---|
| Don't touch<br>PTZ Lever! | Do not operate the PAN/TILT lever and the ZOOM button because they are being initialized. |
| Connecting to<br>cameras  | Connecting to the remote cameras has started.   |

## Operation lock

| Indication | Description  |
|------------|--|
| LOCKED!    | Operation is disabled. <ul style="list-style-type: none"> <li>When an operation is performed while the indicator of the ENABLE button of the corresponding area is off.</li> <li>When a number button with a menu assigned is pressed while menu operation is disabled.</li> </ul> |

## IP connection settings

| Indication                     | Description   |
|--------------------------------|---|
| Unavailable<br>network setting | The entered IP address, subnet mask, or port number cannot be set. Enter a correct value.<br>⇒ "Network settings of the unit" in <Basics> (page 27)   |
| IP Duplicate!                  | The entered IP address is a duplicate of the IP address set for another item (the connection destination IP address for another camera number or the switcher or the IP address of the unit). |
| Please reboot<br>AW-RP120      | The unit needs to be rebooted. Turn the unit's power off and then back on.  |

## When setting the connection types for remote cameras

| Indication           | Description  |
|----------------------|--|
| Setting<br>CTRL TYPE | The connection types for remote cameras are being changed. |

## Preset memory

| Indication                     | Description   |
|--------------------------------|---|
| CAM### PMEM<br>STORE COMPLETE  | Preset memory registration has completed.   |
| CAM### PMEM<br>DELETE COMPLETE | Preset memory deletion has completed.   |
| Used by TMEM.                  | Overwriting or deletion is not possible because tracing memory is registered to the selected number button. |

- A number is displayed instead of "#".

## Tracing memory

| Indication                             | Description   |
|--|---|
| CAM##: TMEM<br>#m###s Remained.        | # minutes ## seconds of recording is still possible for the tracing memory of CAM##.      |
| TM##:<br>Standby Store                 | The recording standby state of tracing memory.  |
| TM##:<br>Waiting Opr.                  | The recording operation wait state of tracing memory.                                     |
| TM##: #m###s<br>Storing...             | Recording tracing memory.   |
| TM##: #m###s/#m###s<br>Standby Recall  | The recall wait state of tracing memory.  |
| TM##: #m###s/#m###s<br>Recalling...    | Recalling tracing memory.   |
| TM##: #m###s/#m###s<br>Standby Restore | The restore standby state of tracing memory.  |
| TM##: #m###s/#m###s<br>Restoring...    | Restoring tracing memory.   |
| Please wait<br>FLASH Accessing.        | Writing data to the flash memory in the unit after recording or restoring tracing memory. |
| CAM GRP can't be<br>changed in TMEM    | The camera group cannot be switched in TMEM mode.   |
| TMEM<br>DELETE COMPLETE                | Tracing memory deletion has completed.  |

- A number is displayed instead of "#".

Memory card

| Indication                         | Description   |
|------------------------------------|---|
| NO CARD!                           | No card is inserted.  |
| INITIALIZING...<br>NOT REMOVE CARD | Initializing.   |
| SAVING...<br>NOT REMOVE CARD       | Saving data to the memory card.<br>Do not remove the memory card.   |
| LOADING...<br>NOT REMOVE CARD      | Reading data from the memory card.<br>Do not remove the memory card.  |
| COMPLETE                           | Initializing, saving, or loading is completed.  |
| WRITE PROTECTED!                   | The memory card is write protected.   |
| OVER 99FILES!                      | Saving is not possible because there are already 99 files.  |
| INSUFFICIENT CAPACITY!             | Saving is not possible because there is insufficient free space in the memory card.   |
| LOAD ERROR!                        | A file cannot be read by the unit or selected remote camera. The following files are incompatible. <ul style="list-style-type: none"> <li>● A file saved with a different model than the currently selected remote camera.</li> <li>● A file containing corrupted data</li> </ul> |

Setup software

| Indication  | Description  |
|---|--|
| Not connected.  | The unit and personal computer are not connected.  |
| Already assigned.   | The image input of the selected switcher is already selected for another camera number.<br>Take care not to make a duplicate selection.  |
| IP(###.###.###.###) duplicate.                                    | The entered connection destination IP address (###.###.###.###) is a duplicate of either the IP address of the unit or a connection destination IP address for another camera number or the switcher.                            |
| Unavailable network setting.                                      | The entered IP address and port number cannot be set.<br>Set correct values.<br>⇒ "Network settings of the unit" in <Basics> (page 27)<br>⇒ "Settings for connecting with the remote cameras and switcher" in <Basics> (page 29) |
| Please reboot AW-RP120.   | The unit needs to be rebooted.<br>Turn the unit's power off and then back on.  |
| Old User Name or Old Password is incorrect.                       | The entered user name or password does not match the value set on the unit.  |
| Entered information is incorrect. Enter again.                    | The entered information includes characters that cannot be used on the unit.   |
| Complete the "Old User Name" field.                               | Enter the user name in the "Old User Name" box.  |
| Complete the "New User Name" field.                               | Enter the user name in the "New User Name" box.  |
| Complete the "Old Password" field.                                | Enter the password in the "Old Password" box.  |
| Complete the "New Password" field.                                | Enter the password in the "New Password" box.  |
| Complete the "Retype New Password" field.                         | Enter the password in the "Retype New Password" box.   |
| Password entered in the "Retype New Password" field is incorrect. | The password entered in the "Retype New Password" box does not match the one entered in the "New Password" box.  |

- A number is displayed instead of "#".

# Index

## Menu

|                            |      |
|----------------------------|------|
| [21] SHUTTER               |      |
| 1. SHUTTER .....           | 8    |
| 2. SPEED .....             | 8    |
| [22] ND FILTER .....       | 10   |
| [23] FUNCTION              |      |
| 1. OPTION .....            | 26   |
| 2. DEFROSTER .....         | 26   |
| 3. WIPER .....             | 26   |
| 4. HEATER/FAN .....        | 26   |
| 5. LAMP .....              | 26   |
| [24] CAMERA SETUP          |      |
| 1. CAM POWER .....         | 3, 4 |
| 2. AUTO ON .....           | 3    |
| 3. RECALL PST SPD .....    | 15   |
| 4. TALLY OUT .....         | 39   |
| 5. HOME POSITION .....     | 25   |
| [25] RP SETUP              |      |
| 1. FOCUS/IRIS .....        | 29   |
| 2. P/T CURV .....          | 22   |
| 3. LCD BACKLIGHT .....     | 29   |
| 4. ENABLE BUTTON .....     | 28   |
| 5. MENU CONTROL .....      | 28   |
| [26] PAN DIRECTION .....   | 23   |
| [27] TILT DIRECTION .....  | 23   |
| [28] ZOOM DIRECTION .....  | 23   |
| [29] FOCUS DIRECTION ..... | 24   |
| [30] PTZ ADJUST            |      |
| 1. Z MIN SPEED .....       | 24   |
| 2. SPEED WITH Z .....      | 24   |
| 3. LIMIT UP .....          | 25   |
| 4. LIMIT DOWN .....        | 25   |
| 5. LIMIT LEFT .....        | 25   |
| 6. LIMIT RIGHT .....       | 25   |
| [31] PM GRP1               |      |
| 1. PM GRP1 MODE .....      | 16   |
| 2. PM GRP1 1/10 .....      | 16   |
| 3. PM GRP1 2/10 .....      | 16   |
| 11. PM GRP1 10/10 .....    | 16   |
| 12. PM GRP1 ALL .....      | 17   |
| [35] USER BUTTON .....     | 30   |
| [42] SW FUNCTION           |      |
| 1. SWLINK .....            | 31   |
| 2. BUSCONT .....           | 32   |
| 3. BUS .....               | 32   |
| 4. FOCUS ASSIST .....      | 33   |
| 5. CAMERA SELECT .....     | 33   |
| 6. TALLY_IP .....          | 34   |
| 7. P/T/Z CONTROL .....     | 34   |
| 8. CAM INF .....           | 35   |
| 9. CAMINF_FORMAT .....     | 35   |
| 10. CAMINF_CNAME .....     | 35   |
| 11. CAMINF_SCENE .....     | 35   |
| 12. CAMINF_GAIN .....      | 35   |
| 13. CAMINF_SHUTER .....    | 35   |
| 14. CANINF_IRIS .....      | 35   |
| 15. CAMINF_FILTER .....    | 35   |
| 16. CAMINF_ALARM .....     | 35   |
| [43] SW INPUT .....        | 31   |
| [44] TALLY .....           | 39   |
| [45] GPI OUT               |      |
| 1. CAM OUT1 .....          | 44   |

|                      |        |
|----------------------|--------|
| [46] SD SAVE .....   | 37     |
| [47] SD LOAD .....   | 38     |
| [48] SD DELETE ..... | 37, 38 |
| [49] SYSTEM          |        |
| 1. INITIALIZE .....  | 42     |
| [50] ALARM .....     | 40     |

## A

|                  |   |
|------------------|---|
| ABB button ..... | 7 |
| ATW button ..... | 7 |
| AWB button ..... | 6 |

## B

|                   |   |
|-------------------|---|
| BARS button ..... | 8 |
| B GAIN dial ..... | 7 |
| B PED dial .....  | 7 |

## C

|                                      |       |
|--------------------------------------|-------|
| CAMERA OSD button .....              | 11    |
| Color adjustment ENABLE button ..... | 5, 27 |
| Color adjustment section .....       | 5     |

## D

|                     |   |
|---------------------|---|
| DETAIL button ..... | 8 |
|---------------------|---|

## F

|                                     |    |
|-------------------------------------|----|
| FOCUS SPEED dial .....              | 22 |
| FOCUS/ZOOM/IRIS ENABLE button ..... | 27 |

## G

|                   |   |
|-------------------|---|
| GAIN button ..... | 6 |
|-------------------|---|

## L

|                     |    |
|---------------------|----|
| LAN connector ..... | 44 |
|---------------------|----|

## M

|                         |            |
|-------------------------|------------|
| MEM ENABLE button ..... | 12, 18, 27 |
|-------------------------|------------|

## P

|                              |    |
|------------------------------|----|
| PAN/TILT ENABLE button ..... | 27 |
| PAN/TILT SPEED dial .....    | 22 |
| PED dial .....               | 6  |
| PMEM button .....            | 12 |
| PM GRP 1 button .....        | 17 |
| PM GRP 2 button .....        | 17 |
| PM GRP 3 button .....        | 17 |
| PM GRP 4 button .....        | 17 |

## R

|                   |    |
|-------------------|----|
| REMOTE .....      | 44 |
| R GAIN dial ..... | 7  |
| R PED dial .....  | 7  |

**S**

|                      |       |
|----------------------|-------|
| SCENE 1 button ..... | 9     |
| SCENE 2 button ..... | 9     |
| SCENE 3 button ..... | 9     |
| SCENE 4 button ..... | 9     |
| Setup Software ..... | 45    |
| SHIFT button .....   | 9, 17 |

**T**

|  |    |
|--|----|
| TALLY/GPI .....                          | 43 |
| TMEM button .....                        | 18 |
| TO PAN/TILT HEAD 1 to 5 connectors ..... | 44 |
| Tracing memory operation section .....   | 18 |

**U**

|                          |        |
|--------------------------|--------|
| USER button .....        | 30     |
| USER ENABLE button ..... | 17, 27 |

**W**

|                          |      |
|--------------------------|------|
| WHITE BAL A button ..... | 6, 7 |
| WHITE BAL B button ..... | 6, 7 |

**Z**

|                       |    |
|-----------------------|----|
| ZOOM SPEED dial ..... | 22 |
|-----------------------|----|

**Panasonic Corporation**

Web Site: <http://panasonic.net>

**パナソニック株式会社 プロフェッショナルAVビジネスユニット**

〒571-8503 大阪府門真市松葉町2番15号 ☎(06)6901-1161

©Panasonic Corporation 2012